



ELITE ROBOTS CS Series CS620 User Manual

Suzhou Elite Robot Co., Ltd

2023-12-12

Version: 2.10.0

Please read this manual carefully before use

Please carefully check the version informations in this manual matches the corresponding software version of the system, to ensure consistency.

This user manual shall be periodically checked and revised, and the renewed contents will appear in the new version. The contents or information herein is subject to change without prior notice.

ELITE ROBOT Co., Ltd. shall assume no liability for any errors which will occur in the manual probably.

ELITE ROBOT Co., Ltd. shall assume no liability for the accident or indirect injury as a result of using this manual and the product mentioned herein.

Please read this manual before installing and using the product.

Please keep this manual so that you can read and use it for reference at any time.

The pictures in the specification shall be used for reference only. The goods received shall prevail.

Table 1 Version information

Name	Version
Software version	V2.10.0
Servo version	V2.10.100
Terminal IO version	V2.10.4
Mechanical version	V1.1.1
Hardware version	V2.32
Service manual	V2.10.0
Script manual	V2.10.0

Contents

Part I Robot General.....	1
1 Safety.....	2
1.1 Introduction.....	2
1.2 Responsibilities and Specifications	2
1.3 Limitation of Liability.....	3
1.4 Warning Symbols.....	3
1.5 Safety Precautions.....	4
1.5.1 Summary	4
1.5.2 Instructions for Use.....	5
1.5.3 Personnel Safety	7
1.6 Intended Service.....	8
1.7 Risk Assessment	9
1.8 Emergency Handling.....	10
1.8.1 Emergency Stop Device.....	10
1.8.2 Recovery from Emergency	11
1.8.3 Emergency Forced Movement of Joints	11
2 Safety Related Functions and Interfaces.....	13
2.1 Introduction.....	13
2.1.1 Stop Category	14
2.1.2 Operation Mode and Safety Mode	14
2.2 Safety Function Description.....	15
3 Transporting	22
4 Quick Start.....	23

4.1 Robot System Introduction.....	23
4.2 Robot System Installation.....	24
4.2.1 Robot Arm Installation	24
4.2.2 Robot Controller and Teach Pendant Installation	25
4.3 Cable Connection	26
4.3.1 Robot arm and Controller Connection	26
4.3.2 Controller and Mains Supply Connection.....	27
4.4 Power on The Robot.....	28
4.4.1 Preparation before Power on	28
4.4.2 Switch Robot Arm	29
4.5 First Task.....	29
Part II Robot Hardware.....	31
5 Mechanical Structure	32
5.1 Introduction.....	32
5.2 Robot Workspace.....	32
5.2.1 Robot Mechanical Dimensions	32
5.2.2 Robot Workspace	33
5.2.3 DH Parameters	33
5.3 Mounting	34
5.3.1 CS620 Robot Arm Mounting	35
5.3.2 End Effector Mounting	36
5.3.3 Controller and Teach Pendant Mounting.....	38
5.3.4 Electrical Specifications	38
6 Electrical Interface.....	40

6.1 Introduction.....	40
6.2 Electrical Warnings and Precautions.....	40
6.3 Electrical Interface of Controller	42
6.3.1 External Electrical Interface	42
6.3.2 Internal Electrical Interface.....	43
6.4 Teach Pendant Electrical Interface.....	60
6.5 Robot Arm Electrical Interface	60
6.5.1 Robot Arm Base Electrical Interface	61
6.5.2 Robot Arm Tool End IO Interface	61
Part III Robot Software Operation.....	72
7 Software Overview	73
8 Status and Menu Bar	76
8.1 Robot Status	76
8.1.1 Turn on Robot Power	76
8.1.2 Setting Payload	78
8.2 Task and Profile Management.....	79
8.2.1 New.....	80
8.2.2 Open	82
8.2.3 Preservation.....	84
8.3 Menu Shortcut	85
8.4 File Manager	86
9 System Configuration.....	88
9.1 About	88
9.2 Setting	88

9.2.1 Preferences	88
9.2.2 Password.....	89
9.2.3 System	92
9.3 Shut down	101
10 Run Tab	102
10.1 Log.....	102
10.2 Status.....	103
10.3 Variable.....	103
11 Configuration Tab	105
11.1 General	105
11.1.1 Mounting.....	105
11.1.2 TCP.....	106
11.1.3 Payload	109
11.1.4 Global Variable	111
11.1.5 Frame	112
11.1.6 IO	114
11.1.7 Home	119
11.1.8 Startup	120
11.1.9 Tool IO.....	122
11.1.10 Conveyor Tracking	126
11.1.11 Package Position	127
11.2 Safety.....	129
11.2.1 Safety Home.....	129
11.2.2 Robot Limits.....	131

11.2.3 Joint Limits	132
11.2.4 Safety I/O	133
11.2.5 Safety Plane	136
11.2.6 Safety Tool	139
11.2.7 Three Position	139
11.2.8 Hardware	140
11.2.9 Safety Parameters	141
11.3 Communication	142
11.3.1 Modbus	142
11.3.2 Profinet	144
11.3.3 Ethernet/IP.....	144
11.4 Plugin.....	145
12 Task Tab.....	147
12.1 Task Tree.....	148
12.1.1 Task Tree Toolbar	149
12.1.2 Expression Editor	149
12.2 Instruction Tab.....	150
12.3 Monitor Tab.....	152
12.4 Basic Task Node	153
12.4.1 Move.....	153
12.4.2 Waypoint.....	158
12.4.3 Direction	161
12.4.4 Wait.....	163
12.4.5 Set.....	164

12.4.6 Popup.....	165
12.4.7 Halt	167
12.4.8 Comment	167
12.4.9 Folder.....	168
12.4.10 Set Payload	169
12.5 Advanced Task Node	170
12.5.1 Loop	170
12.5.2 Subtask	171
12.5.3 Assignment	174
12.5.4 If.....	176
12.5.5 Script.....	177
12.5.6 Event	178
12.5.7 Thread.....	178
12.5.8 Switch	179
12.5.9 Timer.....	180
12.5.10 Home.....	181
12.6 Composite.....	182
12.6.1 Palletizing	182
12.6.2 Conveyor	187
12.6.3 Trajectory Record	189
12.7 Plugin.....	190
12.8 Breakpoint debugging	191
12.9 Single-step function.....	192
13 IO Tab	194

13.1 Internal	194
13.1.1 Robot	194
13.1.2 Modbus Slave	195
13.2 Modbus	196
14 Jog Tab	197
14.1 Robot	197
14.1.1 Tool and Frame	197
14.1.2 Home, Drag, and Alignment	198
14.2 Tool Position	198
14.3 Joint Position.....	199
14.3.1 TCP Translation or TCP Orientation.....	200
14.4 Edit Pose Page.....	200
14.5 Move Interface	201
15 Bus Protocol.....	203
15.1 Introduction.....	203
15.2 Modbus Protocol.....	203
15.2.1 Introduction.....	203
15.2.2 Working Principle.....	203
15.2.3 Register Description	204
15.2.4 Modbus Function Code.....	204
15.2.5 Modbus Function Code.....	205
15.2.6 Register Mapping Relationship and Configuration Instructions	206
15.3 RTSI Protocol	206

15.3.1 Introduction.....	206
15.4 Profinet Protocol.....	207
15.4.1 Profinet Specification.....	208
15.5 Ethernet/IP Protocol	208
15.6 30001 Communication Interface Protocol.....	209
15.6.1 Introduction.....	209
15.6.2 Package Format	209
15.6.3 Script Control and Rules.....	210
15.7 29999 Communication Interface Protocol.....	211
15.7.1 Introduction.....	211
15.7.2 Connect EliRobot	211
15.7.3 Dashboard Shell Commands.....	212
Part IV Maintenance and Quality	213
16 Maintenance and Disposal	214
16.1 Maintenance	214
16.2 Disposal	215
16.3 Maintenance	215
17 Quality Assurance	216
17.1 Product Quality Assurance.....	216
17.2 Disclaimer.....	216
Part V Appendix.....	218
I Glossaries.....	219
II Technical Specifications	220
III Application Standard	222

IV Certificate.....	224
V Alarm Information	228

Part I Robot General

1 Safety

1.1 Introduction

This chapter introduces the safety principles and specifications that should be followed when operating the CS620 robot. The integrator and the user must read this manual carefully and comply with all safety guidelines and warning labels. Users must fully understand the inherent risks of operating the robot arm, and strictly comply with the requirements listed in this manual. The user and the integrator must comply with ISO 10218 Industrial Robots - Safety Specification.

1.2 Responsibilities and Specifications

The CS620 robot can be used together with other equipment. Therefore, the information in this manual does not include how to comprehensively design, install and operate the robot to be used together with other equipment, nor does it include the possibility that the above use will affect the surrounding equipment. The safety of robot mounting depends on how the robot is integrated. The integrator needs to follow the laws, regulations, safety specifications and standards of the host country to conduct risk assessment on the design and mounting of the system.

A risk assessment is the most important task that intergrators or operators must complete. The intergrators may perform the risk assessment by using the following standards for reference:

- ISO 12100:2010 Safety of machinery - General principles for design - Risk assessment and risk reduction;
- ISO 10218-2:2011 Robots and robotic devices - Safety requirements for industrial robots - Part 2: Industrial robot system and integration;
- RIA TR R15.306-2014 Technical report of industrial robots and robot systems - Safety requirements and task-based risk assessment method;
- ANSI B11.0-2010 Safety of machinery – General requirements and risk assessment.

The ELITE Robot integrators should perform, but not limited to, the following responsibilities:

- Make a comprehensive risk assessment for the complete robot system;
- Confirm that the design and mounting of the robot and supporting equipment are accurate;
- Provide training to users and staff;
- Create a complete system operation specification and clarify the use process description;
- Establish appropriate safety measures;
- Use appropriate methods to eliminate dangers or minimize all dangers to an acceptable level during final mounting;
- Communicating risks to end users;
- Mark the integrator's logo and contact information on the robot;
- Archive relevant technical documents.

For applicable standards and legal guidelines, please visit the website: www.eliterobots.com.

1.3 Limitation of Liability

All safety information contained in this manual shall not be regarded as the guarantee of Suzhou ELITE Robot Co., Ltd. even if all safety instructions are observed, personal injury or equipment damage may still occur.

Suzhou ELITE Robot Co., Ltd. is committed to continuously improving the reliability and performance of products, and therefore reserves the right to upgrade products without notice. Suzhou ELITE Robot Co., Ltd. strives to ensure the accuracy and reliability of the contents of this manual, but is not responsible for any errors or missing information.

1.4 Warning Symbols

The following warning symbols define the hazard level regulations contained in this manual, please comply with these symbols.

1 Safety

DANGER



This indicates a hazardous situation which, if not avoided, will result in death or serious injury.

WARNING



This indicates a hazardous situation which, if not avoided, may result in death or serious injury.

REMINDER



This indicates a hazardous situation, which, if not avoided, may result in minor or moderate injury.

WARNING



This indicates a potentially hazardous electrical situation which, if not avoided, could result in injury or major damage to the equipment.

WARNING



This indicates a potentially hazardous hot surface which, if not avoided, may result in burns.

1.5 Safety Precautions

1.5.1 Summary

This manual contains methods to protect users and prevent machine damage. Users need to read all relevant descriptions in the manual and be fully familiar with safety matters. This manual covers various situations, but because there are too many possibilities, it is impossible to record all of the potential hazards and countermeasures.

1.5.2 Instructions for Use

The following basic information needs to be understood and followed when starting the robot or robot system for the first time. Other safety related information is introduced in other parts of the manual. In practical application, specific problems need to be analyzed.

REMINDER

1. Please be sure to install the robot and all electrical equipment according to the requirements and specifications in this manual.
 2. Before using the robot for the first time and putting it into production, it is necessary to conduct preliminary test and inspection on the robot and its safeguard system.
 3. Before the first time startup, it is necessary to check the system and equipment are complete, operation is safe and no damage is detected. The system and equipment must comply with the national or regional effective safety production laws and regulations. All safety functions must be tested.
 4. The user must ensure all safety parameter and user tasks are correct, all safety functions work normally. The person who checks each safety function needs to be qualified to operate the robot. Only after passing the comprehensive and careful safety test, the robot can be started.
-

REMINDER

1. The robot must be installed and debugged by professionals according to the mounting standards.
 2. Once the robot is installed, a comprehensive risk assessment shall be conducted again and documented.
 3. Safety parameters must be configured by authorized personnel only. Users can prevent unauthorized personnel from accessing configurations by setting passwords. Every time the safety parameters are modified, the relevant safety functions shall be analyzed by professionals.
 4. In case of accident or abnormal operation, the emergency stop switch
-

can be pressed to stop the robot movement.

5. The CS620 joint module is equipped with a brake, which maintain the posture when the robot is power off. Do not manually disconnect the power supply system frequently. It is recommended to have a time interval more than 10 seconds between each power on and off.
 6. The CS620 has the collision detection. When the external force applied on the robot arm exceeds the normal force range set by the user, the robot will automatically stop to prevent personnel injury and equipment damage. This function is specially set on CS620 for the safety of man-machine cooperative work, but it requires the robot system to stay in the normal operation range and use the Elite cooperative robot series controllers. Otherwise the robot will not have the above functions and the user will borne the dangerous consequences.
-

WARNING

1. The robot and the controller may generate heat during running. Please do not operate or touch the robot when it is working or just after it has stopped working.
 2. Provide ample time for the robot to cool down after pausing operations.
 3. Do not place hands near or around the heating part of the controller.
-

REMINDER

1. Ensure that the robot's arms and tools are correctly and safely installed in place.
 2. Ensure that the robot arm has enough space to move freely.
 3. If the robot is damaged, do not use it.
 4. Do not connect the safety equipment to the normal IO interface. Only the safety IO interface can be used.
 5. Ensure correct configuration (e.g. mounting angle of robot, load in TCP, TCP offset, safety configuration). Save and load the user data into the task.
 6. Tools and obstacles shall not have sharp corners or twist points.
-

7. Ensure that all operators are outside the reach of the robot.
 8. Pay attention to the movement of the robot when using the teach pendant.
 9. Connecting different machines may aggravate the danger or cause new danger. If the robot and supporting equipment need different safety and emergency shutdown performance levels, a relatively higher performance level shall be selected.
 10. Read and understand the manual corresponding to the robot and supporting equipment.
 11. Do not change the hardware nor the system of the robot. Changes to the robot may cause risks that cannot be predicted by the integrator. Robot authorization and reorganization shall be in accordance with the latest version of service manual and other maintenance manuals. If the robot is modified in any other way, Suzhou ELITE Robot Co., Ltd. refuses to bear all responsibilities.
 12. Before transporting the robot, the user needs to check the insulation and protective measures.
 13. When handling the robot, observe the transportation requirements and handle it carefully to avoid collision.
-

REMINDER

1. When the robot works with machinery that may cause damage to the robot, please check the function and task of the robot separately.
 2. Do not expose the robot to permanent magnetic field all the time. A strong magnetic field can damage the robot.
 3. Suzhou ELITE Robot Co., Ltd. shall not be liable for robot damage and personal injury caused by task error or improper operation.
-

1.5.3 Personnel Safety

Before operating the robot, it's necessary to take appropriate measures to ensure the safety of operators.

1 Safety

Precautions are as follows:

1. The personnel operating the robot shall receive and pass the training course sponsored by Suzhou ELITE Robot Co., Ltd. Users need to ensure that they fully grasp the safe and standardized operation process and have robot operation qualification. For training details, please contact our company at service@elibot.com.
2. When operating the robot, please do not wear loose clothes or jewelry (such as necklaces, bracelets, rings, earrings, etc.) and ensure the long hair is tied behind the head.
3. During the operation of the equipment, even if the robot seems to have stopped, the robot may be still in middle of an operation and just be waiting for a signal to start next motion, which means robot could start moving at anytime. Therefore, the robot should be regarded as moving unless the operation is stopped.
4. Draw lines on the floor to mark the action range of the robot, so that the operator can understand the action range of the robot including holding tools (manipulator, tools, etc.).
5. Establish protective measures for the operator (e.g. ropes) and people around the robot operation area (e.g. to ensure safety). Locks shall be set as required so that no one other than the operator can access the power supply of the robot.
6. When using the operation panel and teach pendant, operation errors may occur due to wearing gloves. Be sure to take off the gloves before operation.
7. In emergency and abnormal situations such as people being clamped or surrounded by the robot, the robot arm can be pushed or pulled by force (at least 700 N) to force the joints to move. Forcing robot to move by hand without power is limited to emergency and may damage robot joints.

1.6 Intended Service

The ELITE cooperative robot is limited to general industrial equipment, such as operating or fixing tools and equipment, processing or transferring parts and products.

Elite cooperative robot has special safety level characteristics that allows cooperative operations without peripheral safety safeguard devices or field sensing devices. However it requires rigorous risk prediction to prevent unacceptable hazard including but not limited to expected or accidental contact between staffs (or equipment, machines, devices, etc.) and cobot (or its end effector) in the cooperative work area will not pose an unacceptable risk.

The robot controller and robot are only used for general industrial equipment and cannot be used for applications contrary to the intended use. The prohibited uses include but are not limited to the following situations:

- Used in flammable and explosive environment;
- A device used to move or carry people or other animals;
- Devices such as medical equipment for human life;
- Devices used to have a significant impact on sociality and publicity;
- Used in the vibration environment of vehicle and ship;
- Used for climbing tools.

1.7 Risk Assessment

The risk assessment shall consider all potential contact between the operator and the robot during normal use and foreseeable misoperation. The neck, face and head of the operator shall not be exposed to avoid touching. When using a robot without using peripheral safety safeguard devices, it is necessary to conduct a risk assessment first to determine whether the relevant hazards will constitute an unacceptable risk, such as:

- Danger may exist when sharp end effectors or tool connectors are used;
- Danger may exist when handling toxic or other hazardous substances;
- Danger of operator fingers being caught by robot base or joints;
- Danger of collision by robot;
- Danger that the robot or the tool connected to the end is not fixed in place;
- Danger caused by impact between robot payload and solid surface.

The integrators must measure such hazards and their related risk levels through risk assessment, and determine and implement corresponding measures to reduce the risks to an acceptable level. Please note that there may be other significant hazards associated with certain robotic devices.

1 Safety

By combining the inherent safety design measures applied by ELITE cooperative robots with the safety specifications or risk assessment implemented by integrators and end users, the risks related to CS620 cooperative operation are reduced to a reasonable and feasible level as far as possible. Through this document, any residual risks of the robot before mounting can be communicated to the integrator and the end user. If the integrators determine the risks in the specific application may pose unacceptable hazards to users, the integrators must take appropriate risk reduction measures to eliminate or minimize the risks to an acceptable level. It is not safe to use the cobot without taking appropriate risk reduction measures (if necessary).

If the robot is installed non cooperatively (e.g. when using dangerous tools), the risk assessment may infer that the integrator needs to connect additional safety equipment (e.g. safety start-up equipment) to ensure the safety of personnel and equipment during its programming.

1.8 Emergency Handling

1.8.1 Emergency Stop Device

Pressing the emergency stop button will stop all movements of the robot. Emergency shutdown can not be used as a risk reduction measure, but can be used as secondary protection equipment. If more than one emergency stop button needs to be connected, it must be included in the risk assessment of robot application. The emergency stop button shall meet the requirements of IEC 60947-5-5.

The CS620 is equipped with an emergency stop button on the teach pendant. The button on the teach pendant must be pressed in case of danger or emergency, as shown in Figure 1-1. The controller is equipped with an external emergency stop button port, which can be used by the integrator or user according to the actual situation.



Figure 1-1 Emergency stop button

REMINDER

If the tools or equipment connected to the end pose a potential threat, they must be integrated into the emergency stop circuit of the system. Failure to comply with this warning may lead to significant property damage, serious personal injury or death.

1.8.2 Recovery from Emergency

All emergency stop devices in the form of keys have a "lock" function. This "lock" must be opened to end the emergency stop of the equipment. The "lock" can be opened by rotating the emergency stop button.

Recovering from emergency stop is a simple but very important step. This step can only be operated after ensuring that the danger of the robot system is completely eliminated.

1.8.3 Emergency Forced Movement of Joints

In rare cases, it may be necessary to move one or more robot joints in an emergency when the robot's power supply fails or is not intended to be used. The users can force the robot joints to move by the following methods:

Forced backdrive: push or pull the robot arm with force (at least 700 N) to force the joints to move.

Definition of backdrive function: The backdrive function can be used for the robot to release the stuck state. When entering the backdrive mode, the robot can directly drag by hand. When the force reaches a certain level, the servo will automatically release the holding brake and be pushed.

Trigger condition: When the robot is in standby state, press the drag button and it will enter the backdrive mode.

1 Safety

REMINDER



Forcing robot to move by hand is limited to emergencies and may damage joints.

2 Safety Related Functions and Interfaces

2.1 Introduction

CS620 robot is equipped with a variety of built-in safety functions and electrical IO interfaces include safety IO, digital and analog control signals, which are used to connect other machines and additional protection devices. For the CS620 robot with a standard controller, every safety function and every interface is monitored and designed according to EN ISO13849-1:2015. Refer to Chapter 9 and 11 for the configuration of safety functions, inputs and outputs in the user interface. Refer to Chapter 6 for the connection mode between safety equipment and IO.

REMINDER

1. The use and configuration of safety functions and interfaces must follow the risk assessment task of each robot application task (see section 1.7).
 2. If the robot finds a fault or violation in the safety system (for example, the emergency stop circuit is cut off or a safety limit violation occurs), it will initiate a stop category 0.
 3. The stop time should be considered as part of the application risk assessment.
-

DANGER

1. When the safety configuration parameters used are different from those determined by the risk assessment, it may lead to hazards that cannot be reasonably eliminated or risks that cannot be fully reduced.
 2. Make sure the tool and gripper are connected correctly to avoid danger in case of power interruption.
 3. If the attached equipment only is only configured to 12V, and the operator mistakenly sets the voltage to 24V, the equipment may be damaged.
-

2.1.1 Stop Category

Based on the definition of stop category in IEC 60204-1:2018, the stop category defined in this product is shown in Table 2-1.

Table 2-1 Stop category

Stop Category	Definition
Stop category 0	Uncontrolled stop, by immediately cutting off the power to the actuator to stop the robot.
Stop category 1	Controlled stop, the actuator brakes actively but does not ensure that the robot stops on the trajectory. When the robot stops, cut off the power.
Stop category 2	Controlled stop, the actuator actively brakes and ensures that the robot stops on the trajectory. After the robot stops, the power supply is not cut off.

2.1.2 Operation Mode and Safety Mode

The operation mode and safety mode defined by this product are shown in Table 2-2 and Table 2-3.

Table 2-2 Operation mode

Operation Mode	Description
Automatic mode	The robot automatically runs Python programs.
Manual mode	Use the teach pendant to control the robot movement.
Remote mode	The remote controller is used to control the motion of the robot.

Table 2-3 Safety mode

Safety Mode	Description
Normal mode	Limit of safety parameters during normal operation of robot.
Reduced mode	Safety parameter restrictions when the robot enters the reduced area or uses the three position servo device for drag teach.

2.2 Safety Function Description

The robot safety function is used to reduce the risk of the robot system determined by the risk assessment. This product has 27 safety functions in total. According to the functional purpose, these 27 safety functions can be divided into five categories: emergency stop function (SF01-SF02), safety input (SF03-SF08), safety output (SF09-SF14), joint operation control (SF15- SF16) and whole machine operation control (SF17-SF27), as shown in Table 2-4.

Table 2-4 Safety function list: function definition

Number	Safety Function	Function Definition
SF01	Emergency stop	Press the emergency stop button of the teach pendant to trigger the stop category 1. If the emergency stop function failure, the stop timeout or the stop over distance are detected, the stop category 0 will be triggered.
SF02	External emergency stop	Press the external emergency stop device to trigger the stop category 1 through safety IO or configurable IO. If the external emergency stop function failure, the stop timeout or the stop over distance are detected, the stop category 0 will be triggered.
SF03	Safeguard stop	The external safety safeguard device triggers the stop category 2 through the safety IO or the configurable IO. If the safety safeguard stop function failure, the stop timeout or the stop over distance are detected, the stop category 0 will be triggered.

2 Safety Related Functions and Interfaces

SF04	Safeguard reset	The external safety safeguard restart device releases the robot from the safety safeguard state through the configurable IO. If the failure of safety safeguard restart function is detected, the stop category 0 will be triggered.
SF05	Automatic mode safeguard stop	In automatic mode, the external safety safeguard device triggers stop category 2 through the safety IO or the configurable IO. If the safety safeguard stop function failure, the stop timeout or the stop over distance are detected, the stop category 0 will be triggered.
SF06	Automatic mode safeguard restart	In the automatic mode, the external safety safeguard restart device releases the safety safeguard state of the robot through the configurable IO. If the failure of safety safeguard restart function is detected, the stop category 0 will be triggered.
SF07	3 position enabling device input	In manual mode, when the three position enabling device is released or overloaded, the stop category 2 is triggered through the configurable IO. If the control function failure of the three-position enabling device, the stop timeout or the stop over distance are detected, the stop category 0 will be triggered.
SF08	Emergency stop output	The robot safety controller outputs the emergency stop signal through the configurable IO. If a signal output failure is detected, the stop category 0 will be triggered.
SF09	Operation mode input	The external safety equipment inputs the operation mode signal through the configurable IO, which enables the robot to switch to the manual or automatic mode and triggers the stop category 2. If a signal input failure or a mode switching failure is detected, the stop category 0 will be triggered.
SF10	Reduced mode input	The external safety equipment inputs the reduced mode signal through the configurable IO, which enables the robot to switch to the reduced mode. If a signal input failure or a mode switching failure is detected, the stop category 0 will be triggered.

SF10	Robot motion state output	When the robot is in the motion state (excluding the stop process), the safety controller outputs the robot motion state signal through the configurable IO. If a signal output failure is detected, the stop category 0 will be triggered.
SF11	Robot non stop state output	When the robot is in the non-stop state (including stop process and motion process), the safety controller outputs the robot non-stop state signal through the configurable IO. If a signal output fault is detected, the stop category 0 will be triggered.
SF12	Reduced mode output	When the robot enters the reduced mode, the robot safety controller outputs the reduction mode signal through the configurable IO. If a signal output fault is detected, the stop category 0 will be triggered.
SF13	Non reduced mode output	When the robot does not enter the reduced mode (including normal mode and switching process), the safety controller outputs the non reduced mode signal through the configurable IO. If a signal output fault is detected, the stop category 0 will be triggered.
SF14	Safe Home position output	When the robot TCP reaches the safe Home position, the safety controller outputs the safe home position signal through the configurable IO. If a signal output fault is detected, the stop category 0 will be triggered.
SF15	Joint position limit	Set the upper and lower limits of the joint position. If it is detected that the joint position is close to the limit, the stop category 2 will be triggered; if the joint position overlimit, the stop category 2 function failure, the stop timeout or the stop over distance is detected, the stop category 0 will be triggered.
SF16	Joint speed limit	Sets the upper limit of the joint speed. If the monitored joint speed exceeds the limit, the stop category 0 will be triggered.
SF17	Tool position limit	Set the tool position range. If the monitored tool position is close to the limit, the stop category 2 will be triggered. If the tool position overlimit, the stop category 2 function failure, the stop timeout or the stop over distance are detected, the stop category 0 will be triggered.

2 Safety Related Functions and Interfaces

SF18	Tool speed limit	Set the upper limit of the tool speed. If the tool speed exceeds the limit, the stop category 0 will be triggered.
SF19	Tool force limit	Set the upper limit of the tool force. If the tool force exceeds the limit, the stop category 2 will be triggered. If the stop category 2 function failure, the stop timeout or the stop over distance are detected, the stop category 0 will be triggered.
SF20	Elbow speed limit	Sets the upper limit of the elbow speed. If the elbow speed exceeds the limit, the stop category 0 will be triggered.
SF21	Elbow force limit	Sets the upper elbow force limit. If the elbow force exceeds the limit, the stop category 2 will be triggered. If the stop category 2 function failure, the stop timeout or the stop over distance are detected, the stop category 0 will be triggered.
SF22	Collision power limit	Set the upper limit of the collision power. If the collision power overrun is detected, the stop category 2 will be triggered. If the stop category 2 function failure, the stop timeout or the stop overrun are detected, the stop category 0 will be triggered.
SF23	Collision momentum limit	Set the upper limit of collision momentum. If the collision momentum exceeds the limit, the stop category 2 will be triggered. If the stop category 2 function failure, the stop timeout or the stop over distance are detected, the stop category 0 will be triggered.
SF24	Collision torque limit	Set the upper limit of collision torque. If the collision torque exceeds the limit, the stop category 2 will be triggered. If the stop category 2 function failure, the stop timeout or the stop over distance are detected, the stop category 0 will be triggered.
SF25	Drag teach mode limit	Switch the safety parameter limit from normal mode to drag teach mode. If it is detected that the parameter is abnormal, the corresponding stop category will be triggered (refer to SF15-SF18, SF20). If the stop category 2 function failure, the stop timeout or the stop over distance are detected, the stop category 0 will be triggered.

SF26	Reduced mode limit	Switch the safety parameter limit from normal mode to reduced mode. If it is detected that the parameter is abnormal, the corresponding stop category will be triggered (refer to SF15-SF25). If the stop category 2 function failure, the stop timeout or the stop over distance are detected, the stop category 0 will be triggered.
SF27	Safety plane (space)	Set the safety plane that limits the motion space of the robot. The safety plane divides the space into three areas: safety area (the robot is in the normal mode), reduction area (the robot enters the reduction mode), safeguard area (the robot triggers stop category 2). If the function failure, the stop timeout or the stop over distance are detected, the stop category 0 will be triggered.

2 Safety Related Functions and Interfaces

The functional safety level and safety architecture are defined according to ISO 13849-1:2015, as shown in Table 2-5.

Table 2-5 List of safety functions: function attributes

Number	Safety Function	Safety Level	Safety Architecture	Operation Mode	Safe State
SF01	Emergency stop	PLd	Cat.3	All mode	Cat.1 Stop
SF02	External emergency stop	PLd	Cat.3	All mode	Cat.1 Stop
SF03	Safeguard stop	PLd	Cat.3	All mode	Cat.2 Stop
SF04	Safeguard reset	PLd	Cat.3	All mode	Release from the safeguard
SF05	Automatic mode safeguard stop	PLd	Cat.3	Automatic mode	Cat.2 Stop
SF06	Automatic mode safeguard restart	PLd	Cat.3	Automatic mode	Release from the safeguard
SF07	3 position enabling device input	PLd	Cat.3	Manual mode	Cat.2 Stop
SF08	Emergency stop output	PLd	Cat.3	All mode	Low-level output
SF09	Operation mode input	PLr d	Cat.3	Manual mode	Cat.2 Stop
SF10	Reduced mode input	PLr d	Cat.3	All mode	Reduced mode
SF11	Robot motion state output	PLr d	Cat.3	All mode	Low-level output
SF12	Reduced mode output	PLr d	Cat.3	All mode	Low-level output
SF13	Non-reduced mode output	PLr d	Cat.3	All mode	Low-level output
SF14	Safe Home position output	PLr d	Cat.3	All mode	Low-level output

SF15	Joint position limit	PLr d	Cat.3	All mode	Cat.2 Stop
SF16	Joint speed limit	PLr d	Cat.3	All mode	Cat.0 Stop
SF17	Tool position limit	PLr d	Cat.3	All mode	Cat.2 Stop
SF18	Tool speed limit	PLr d	Cat.3	All mode	Cat.0 Stop
SF19	Tool force limit	PLr d	Cat.3	All mode	Cat.2 Stop
SF20	Elbow speed limit	PLr d	Cat.3	All mode	Cat.0 Stop
SF21	Elbow force limit	PLr d	Cat.3	All mode	Cat.2 Stop
SF22	Collision power limit	PLr d	Cat.3	All mode	Cat.2 Stop
SF23	Collision momentum limit	PLr d	Cat.3	All mode	Cat.2 Stop
SF24	Collision torque limit	PLr d	Cat.3	All mode	Cat.2 Stop
SF25	Drag teach mode limit	PLr d	Cat.3	Manual mode	Cat.2 Stop
SF26	Reduced mode limit	PLr d	Cat.3	All mode	Cat.2 Stop
SF27	Safety plane (space)	PLr d	Cat.3	All mode	Cat.2 Stop

Note: PL (Performance Level) discrete level used to specify the ability of safety-related parts of control systems to perform a safety function under foreseeable conditions. PLr (Required Performance Level) performance level (PL) applied in order to achieve the required risk reduction for each safety function.

3 Transporting

When the robot is hoisted, appropriate measures shall be taken to locate the moving parts, so as not to cause accidental movement and harm in the process of hoisting and transportation. During packaging and transportation, the packaging shall be carried out according to the packaging standard, and the required marks shall be marked on the outside of the packaging box.

During transportation, it is necessary to ensure that the robot is stable and fixed in a proper position.

The controller shall be lifted with a handle.

When the robot is moved to the mounting position from the packaging material, hold the robot until all the screws of the robot base are fastened.

After fixing, power on the robot, and adjust the robot posture to the appropriate position by using the robot drag teach function.

An original package should be kept upon completion of the mounting. The packaging material should stay dry, in case of repackaging the robot in the future.

REMINDER

1. When lifting the robot, please make sure to keep back or shoulder away from overloaded.
 2. All regional and national guidelines should be followed. Suzhou ELITE Robot Co., Ltd. is not responsible for the damage caused during the transportation of the equipment.
 3. Make sure that the robot is installed in accordance with the mounting instructions.
-

4 Quick Start

4.1 Robot System Introduction

The CS620 robot system is mainly composed of robot arm (hereinafter referred to as: arm), robot ERB1C4k0 controller (hereinafter referred to as: controller) and robot teach pendant (hereinafter referred to as: teach pendant), as shown in Figure 4-1.



Figure 4-1 CS620 System

The arm is the main part of the robot system. It is composed of link and joints. Users can use teach pendant to coordinate the actions of these joints.

- Base: perform arm rotary motion;
- Shoulder and elbow: perform extensive work;
- Wrist 1 and wrist 2: perform finer work;
- Wrist 3: Perform the rotation action of the end tool.

The controller is the control part of the robot system, which control the robot movement position, velocity, acceleration, attitude and the equipment connected with the input and output terminals.

Teach pendant is the display and can also be used to operate the robot. The teach pendant mainly includes: a 12.1-inch LCD touch screen, a power switch, an emergency stop button, a drag switch and a connector socket of the teach pendant. LCD touch screen not only show the details of robot motion to the user, including position and attitude parameters, but

4 Quick Start

also facilitate the user's operation. All operations can be completed by directly clicking on the screen.

The design of the teach pendant shell has both aesthetics and ergonomics. Behind it is a nylon rope and two hanging rings. The former is used to hold the teach pendant, and the latter can be used to hang the teach pendant on the controller.

The CS620 robot can be started quickly by referring to the following process:

1. Open the box and take out the robot arm, controller, teach pendant and related cables;
2. Install the robot arm;
3. Install the robot controller and teach pendant;
4. Connect cables;
5. Power on the robot;
6. Write programs to operate robots.

4.2 Robot System Installation

4.2.1 Robot Arm Installation

The installation steps of the robot arm are as follows:

- Unpack and take out the robot arm and controller;
- Install the robot arm on the base.

When installing on the base, use six M10 screws with grade 8.8 strength and six 10.5 mm mounting holes at the bottom. It is recommended to tighten these screws with a torque of 40Nm. If the robot arm mounting position need to be very accurate, drilling two $\varnothing 8$ pin holes and fix them with pins can help guiding. Figure 4-2 shows the drilling position and screw installation position for arm installation. Install the robot on a firm, vibration free surface that is sufficient to withstand at least 10 times the maximum overturning moment of the base joint and at least 5 times the weight of the robot arm. See 5.3.1 for the installation dimensions of robot base.

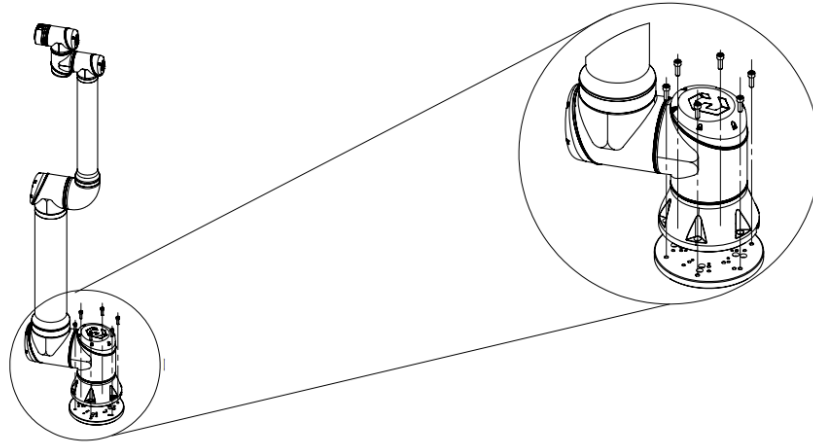

Figure 4-2 Arm installation

4.2.2 Robot Controller and Teach Pendant Installation

The controller can be hung on the wall or placed on the ground. The teach pendant can be hung on the wall or controller. After installing the robot arm and controller, the user can start using the teach pendant.

REMINDER



The controller shall be placed vertically or horizontally on the ground. 50mm gap shall be reserved on each side of the controller to ensure smooth air circulation.

DANGER



1. Ensure that the controller, teach pendant and cable are not in contact with liquid. Wet controllers can cause casualties.
2. The controller and teach pendant shall not be exposed to dust or damp environment exceeding IP54 level. Pay close attention to the environment with conductive dust.

4.3 Cable Connection

There are two socket connectionets at the bottom of the controller. Before use, insert the corresponding cable into the socket, as shown in Figure 4-3.

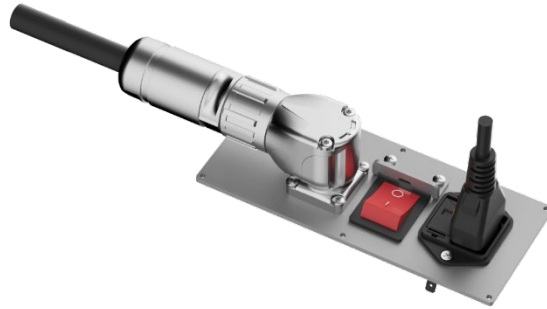
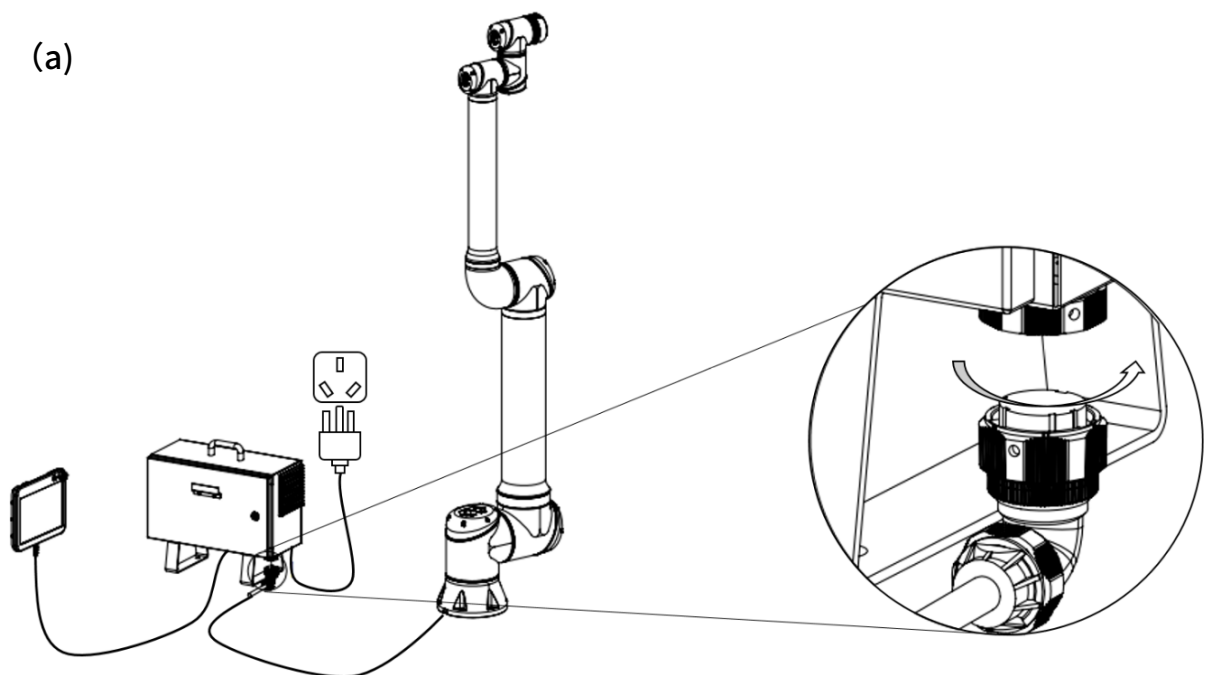

Figure 4-3 CS controller bottom plug

4.3.1 Robot arm and Controller Connection

There is a plug at the end of the cable of the robot arm. Insert the plug into the connector at the bottom of the controller and pay attention to the insertion direction, as shown in Figure 4-4 (a); After that, rotate the whole connector to realize further locking, as shown in Figure 4-4 (b).



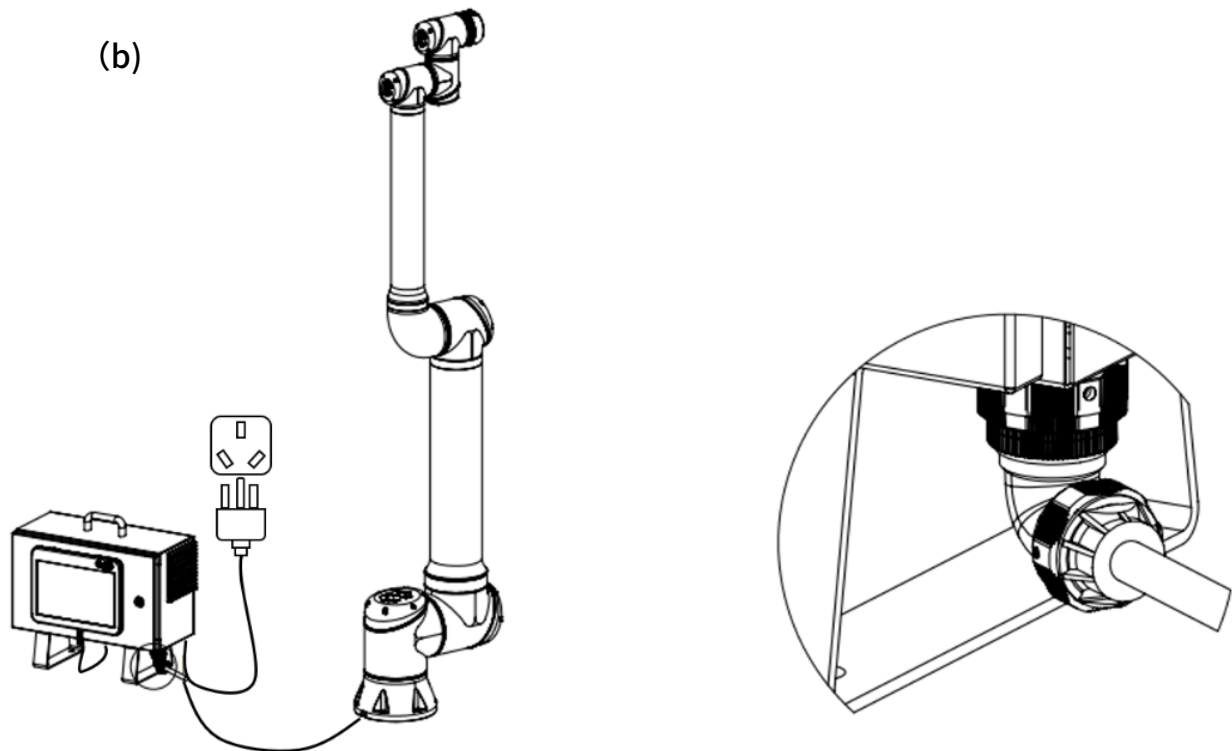

Figure 4-4 Whole machine installation-(a) arm cable not connected;(b) arm cable locking

4.3.2 Controller and Mains Supply Connection

There is a socket at the end of the mains cable in the controller to connect the local dedicated mains cable to the socket. Pay attention to the insertion direction, as shown in Figure 4-5.

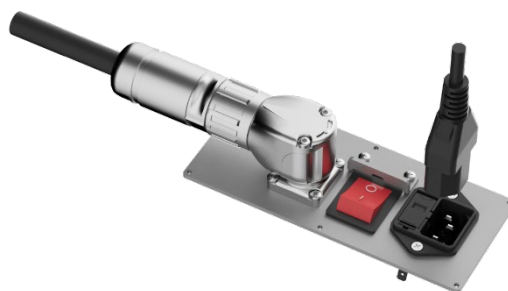

Figure 4-5 Power interface of CS controller

DANGER

1. Please ensure that the robot is grounded in the correct way (electrical grounding). The grounding connector shall have at least the rated current of the highest current in the system.
 2. Please ensure that all cables are correctly connected before the controller is powered on. Always use the original power cord correctly.
-

WARNING

1. Do not disconnect the robot cable when the robot arm is turned on.
 2. Do not extend or modify the original cable.
-

4.4 Power on The Robot

4.4.1 Preparation before Power on

The preparation of the CS620 robot before power on is as follows:

- Check whether the robot is well connected with the controller;
- Check whether the connection between the teach pendant and the controller is intact;
- Check whether the power cable of the controller is well connected;
- The main power switch of the controller is off when the power is not connected;
- The emergency stop switch of the teach pendant is in the pop-up state;
- Ensure that the robot will not touch the surrounding personnel or equipment.

4.4.2 Switch Robot Arm

Click the robot status icon at the top left of the screen to enter the "Robot Status" interface.

First click "Power On", the robot is in the ready state; Click "Brakes Release" again, brakes released, the robot can operate. Click "Exit" in the lower right corner to exit the current page, as shown.

REMINDER



When the holding brakes are released, the robot arm starts, accompanied by sound and slight movement.

4.5 First Task

Users can create tasks and operate the robot by inserting task nodes to the task tree. For most tasks, the whole programming process can be completed using the teach pendant.

After completing the preparations according to section 4.4, power on the controller first and then power on the teach pendant. Click  in the upper left corner of the status and menu bar. Click "Power On" under "Robot Status", then "Brake Release". After Robot in "Normal" mode is checked, click "Exit" at the bottom left to exit the current page. Payload settings need to be configured based on the actual robot status under "Config" tab. If the arm is not mounted on the floor horizontally, mounting settings need to be configured as well under "Config" tab.

Click  on the right of the status and menu bar, choose "Settings > Password > Safety", and set a safety password to unlock safety configuration parameters.

Note: The "Current password" does not need to be entered only when the safety password is set for the first time.

The user can use the operation tab (see Chapter 14) to move the robot arm to the desired position, or press and hold the free drive button on the back of the teach pendant to drag the robot arm to the teach position.

4 Quick Start

The following is a simple task that allows the robot arm to move between two waypoints.

1. Click "New" in the upper right corner of the screen and select "Task".
2. Select "Task > Basic > Waypoint" and add the waypoint to the task tree. At the same time, the default MoveJ is also added to the task tree.
3. Select the created waypoint and click "Set Waypoint" in the "Instruction" interface on the left.
4. Set waypoints. For details, please refer to Chapter 14. The user can also press and hold the free drive button and drag the robot arm to the desired position.
5. If the robot arm is in place, press the "Accept" key, and the new waypoint will be displayed as waypoint_1.
6. Follow steps 2 to 5 to create waypoints_2.
7. Stand in a safe position, the arm moves to the starting point, click  to run the current task in the control bar, and the robot moves at the waypoint_1 and waypoints_2.

TIPS



1. Do not let the robot collide with itself or other objects, which will cause damage to the robot.
 2. This is just a quick start guide for CS620 robot with basic introduction. Please do not increase the speed or acceleration above the default value. Risk assessment should always be carried out before operating the robot.
-

Part II Robot Hardware

5 Mechanical Structure

5.1 Introduction

This chapter describes the basic precautions when installing the CS620 robot and its system components.

5.2 Robot Workspace

5.2.1 Robot Mechanical Dimensions

The mechanical dimensions of the CS620 robot are shown in Figure 5-1.

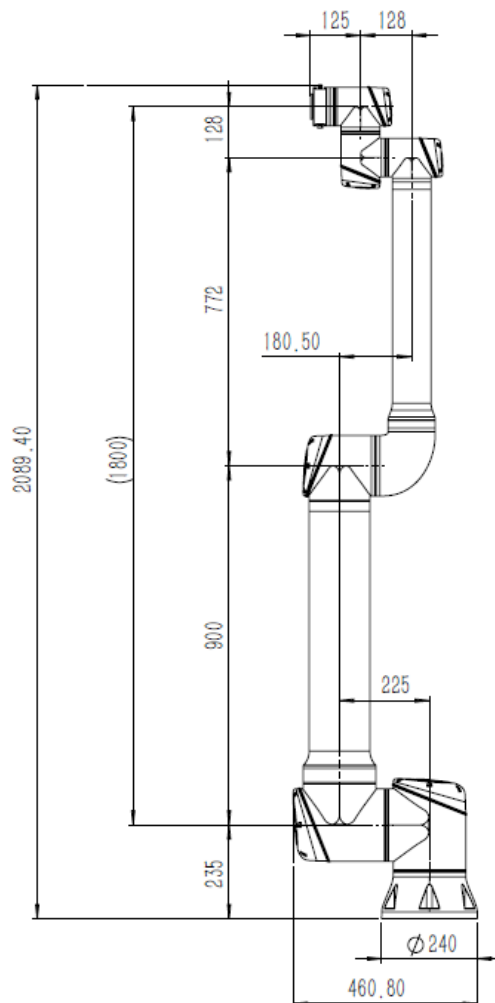

Figure 5-1 Mechanical dimensions of the CS620 robot, with unit of mm

5.2.2 Robot Workspace

The working space of the CS620 robot is shown in Figure 5-2. When the robot moves, the tool center can move within the maximum working range, but try to make the tool center move within the recommended working range as much as possible.

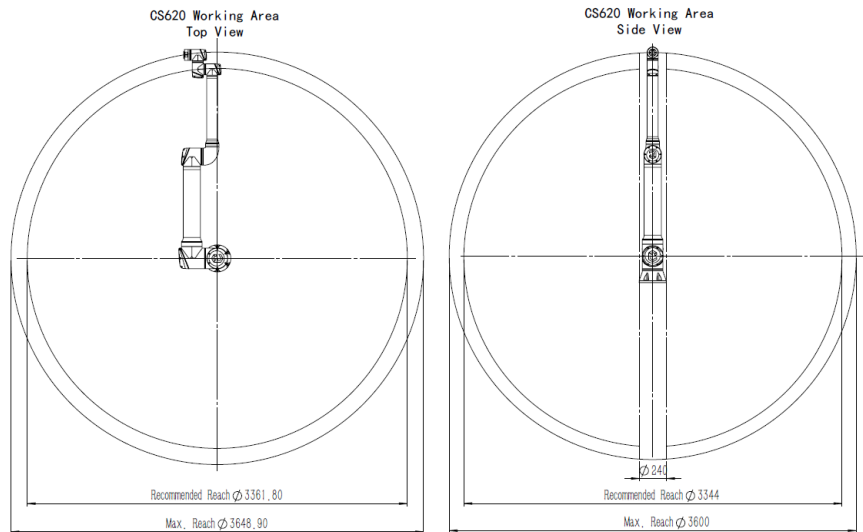

Figure 5-2 Workspace of the CS620 robot, with unit of mm

5.2.3 DH Parameters

Denavit-Hartenberg parameters, or DH parameters, are the tradition way of representing the forward kinematics of robotic arms. They are used to express the position of the tool center point, or TCP, in the base coordinate system given the joint angles of the robot arm, as shown in Figure 5-3.

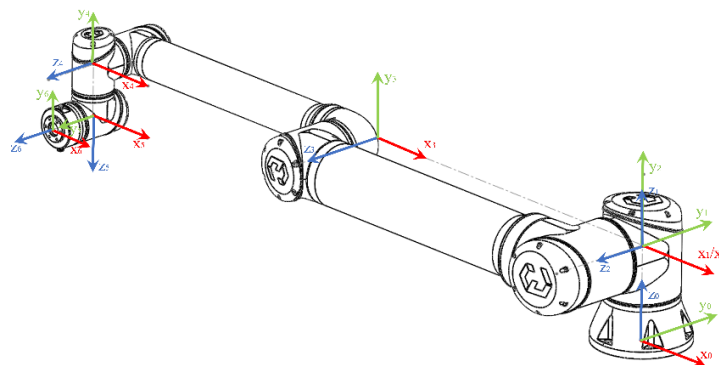

Figure 5-3 Robot DH diagram

The DH parameters of the CS620 are given in table Table 5-1.

Table 5-1 CS620 DH parameters

Joint	theta[rad]	a[m]	d[m]	alpha[rad]
Joint 1	0	0	0.235	0
Joint 2	0	0	0	$\pi/2$
Joint 3	0	-0.900	0	0
Joint 4	0	-0.772	0.1725	0
Joint 5	0	0	0.128	$\pi/2$
Joint 6	0	0	0.125	$-\pi/2$

5.3 Mounting

When designing and installing the CS620 robot, please be sure to follow the following warnings and precautions. These warnings and precautions should also be followed when carrying out maintenance work.

DANGER



1. Do not connect the safety signal to the non-safety IO with improper safety level. Failure to comply with this warning may result in serious casualties due to the failure of a safety stop function. Be sure to separate the safety interface signal from the ordinary IO interface signal.
2. All safety signals have redundancy (two independent channels). Keeping the two channels independent ensures that the safety function will not be lost in the event of a single failure.
3. Some IO inside the controller can be configured as ordinary IO or safe IO. Please read through section 6.3.

WARNING



1. Please make sure the equipment that is not contaminated with water stays dry. If water enters the product, please cut off the power supply and contact the supplier.
2. Only use the original cable of the robot. Please do not use the robot in

those applications where the cable needs to be bent. If longer cables or flexible cables are needed, please contact the supplier.

3. The negative connector is the grounding "GND" connector, which is connected with the protective cover of the robot and the controller. All GND connectors mentioned in this article are only applicable to power supply and signal transmission. For protective grounding (PE), please use the special socket for power supply of the controller to provide reliable grounding for the controller.
 4. Be careful when installing the interface cable to the IO of the robot. The metal plate on the side of the cabinet is used for interface cables and connectors. Please remove this metal plate before drilling. Before reinstalling the metal plate, make sure that all rough surfaces have been removed. Remember to use the correct size gland.
-

REMINDER

1. The robot has passed the electromagnetic compatibility test specified in the international IEC standard. Interference signals higher than the level specified in IEC standards will cause abnormal behavior of the robot. Extremely high signal level or over exposure will cause permanent damage to the robot. EMC problems usually occur during welding and are usually prompted by error messages in the log. Suzhou ELITE Robot Co., Ltd.(ELITE) is not responsible for any loss caused by EMC problems exceeding the certification standard.
 2. The length of IO cable used to connect the controller with other mechanical and plant equipment shall not exceed 10m, unless it is feasible after extension test.
-

5.3.1 CS620 Robot Arm Mounting

Using six M10 screws of grade 8.8 to mount the robot arm through the six 10.5 mm

5 Mechanical Structure

through holes on the robot base. It is recommended to tighten these bolts with a torque of 40Nm. If the robot arm mounting position need to be very accurate, drilling two $\text{Ø}8$ pin holes and fix them with pins can help guiding. It is also possible to purchase an accurate base counterpart to install the robot. Figure 5-4 shows the mounting dimensions of CS620 robot base.

Install the robot on a firm, vibration free surface. The surface must be sufficient to withstand at least 10 times the maximum overturning moment of the base joint and at least 5 times the weight of the robot arm. If the robot is mounted on a linear axis or on a movable platform, the acceleration of the movable mounting base should be very low. High acceleration of the base joint would trigger.

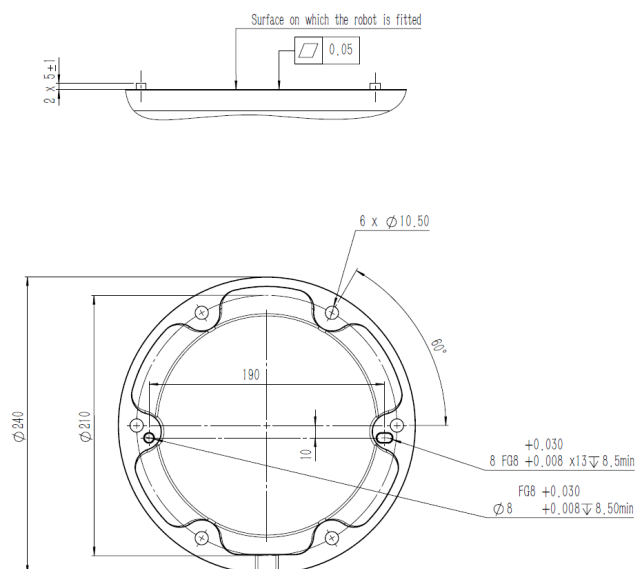

Figure 5-4 Mounting dimension drawing of the CS620 robot base, with unit of mm

5.3.2 End Effector Mounting

The robot end flange has six M6 threaded holes to mount the end effector. When screws are installed in these threaded holes, the screws need to be tightened with a torque of 8Nm and its strength grade is 8.8. If the robot arm mounting position need to be very accurate, please use the guiding pin that fits with the $\text{Ø}6$ hole.

Figure 5-5 shows the mounting dimension drawing of the CS620 robot tool flange. It is recommended to use radial slotted holes for pins to avoid excessive restraint while maintaining accurate position. The screw depth of the mounting tool shall not exceed 8mm.

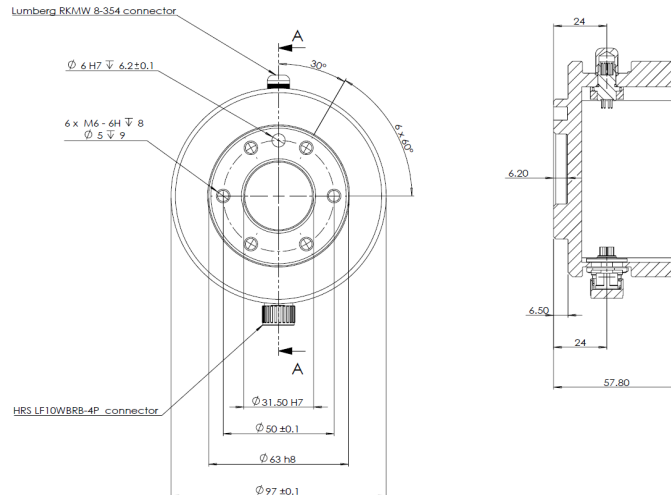

Figure 5-5 Mounting dimension drawing of the CS620 robot tool flange, with unit of mm

DANGER



1. Make sure the tool is properly and securely bolted in place.
2. Make sure the structure of the tools are safe, avoiding the potential of parts falling accident.
3. Installing a tool on the robot that screws in more than 8mm M8 screws may cause irreparable damage to the tool flange, resulting in the replacement of the tool flange.

The max payload diagram is shown in Figure 5-6. This diagram is to show how large a payload the robot can handle based on how far the center of gravity of the tool is from the center of the tool flange.

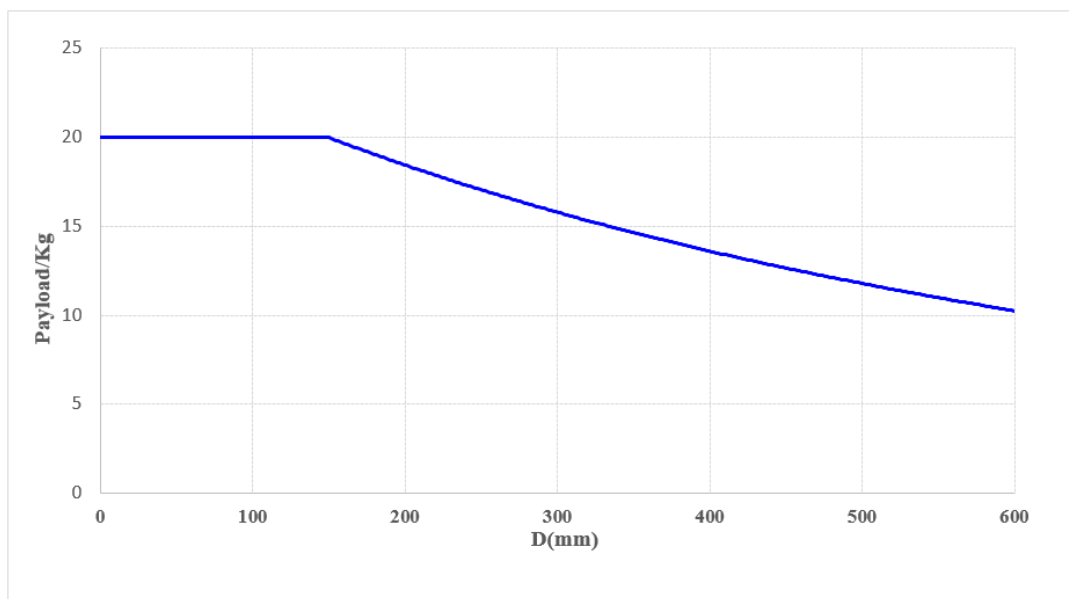

Figure 5-6 Payload diagram

5 Mechanical Structure

The horizontal axis represents how far the center of gravity of the tool is from the center of the tool flange. The vertical axis represents the max allowed payload. The farther the center of gravity of the payload is from the center of the tool flange, the smaller the allowed payload becomes.

REMINDER



1. The payload shown in the diagram indicates a maximum payload. It must not be exceeded under any circumstance.
 2. The robot may be damaged if the payload exceeds the allowable value.
-

5.3.3 Controller and Teach Pendant Mounting

The controller can be hung on the wall or placed on the ground. 50mm gap shall be reserved on each side of the controller to ensure smooth air circulation.

The teach pendant can be hung on the wall or controller. Confirm that the cable will not cause tripping hazard.

Note: Additional brackets for installing the controller and teach pendant are purchasable.

DANGER



1. Make sure that the controller, teach pendant and cable are not in contact with liquid. A damp controller can cause fatal injury.
 2. Place the teach pendant (IP54) and controller (IP54) in an environment suitable for IP level.
-

5.3.4 Electrical Specifications

The power supply shall be equipped with the following accessories:

1. Ground connection;
2. Mains fuse.

Table 5-2 Electrical specifications of the mains connection

Parameter	Min.	Typ.	Max.	Unit
Input voltage (Normal version, AC OEM controller)	90	-	264	VAC
External mains fuse (when the voltage is 90-130V)	-	15	-	A
External mains fuse (when the voltage is 200-240V)	-	15	-	A
Input frequency	47	-	63	Hz

DANGER

1. Please make sure that the robot is grounded correctly (electrical connection to ground). The grounding conductor should have at least the rated current of the max. system current.
2. The lockout and tagout should be implemented for all power supplies when the robot maintenance is required. The robot I/O should not be powered by other equipment when the system is being repaired.
3. Please make sure that all cables are connected correctly before the controller is powered on. Always use the original power cord.

6 Electrical Interface

6.1 Introduction

This chapter describes all electrical interfaces of Elite CS series collaborative robot, these interfaces are mainly distributed in the robot controller, teach pendant and arm. All electrical interfaces will be introduced in detail below, and provide application examples of some interface.

6.2 Electrical Warnings and Precautions

Follow the warnings and precautions below when designing and installing the robot application. These warnings and precautions are also followed for performing maintenance operations.

DANGER

1. Do not connect the safety signals to the non-safety IO with inappropriate safety level. Failure to comply with the warning may cause serious casualties due to the failure of a safety stop function. Be sure to separate the safety interface signal from the normal IO interface signal.
2. All safety signals are redundancy (two separate channels). Keep the two channels separate to ensure that security is not lost in case of a single failure.
3. Some IO inside the controller can be configured as normal IO or safe IO. Please read through section 6.3.

WARNING

1. Please make sure that all equipment not contaminated with water is kept dry. If water enters the product, please cut off the power supply and contact the supplier.
2. Use only the original cable of the robot. Please do not use the robot in those applications where the cable needs to be bent. If longer cables or flexible cables are needed, please contact the supplier.

3. The negative connector is the grounding "GND" connector, which is connected with the protective cover of the robot and the controller. All GND connectors mentioned in this article are only applicable to power supply and signal transmission. For protective grounding (PE), please use the special socket for power supply of the controller to provide reliable grounding for the controller.
 4. Be careful when installing the interface cable to the IO of the robot. The metal plate on the side of the cabinet is used for interface cables and connectors. Please remove this metal plate before drilling. Before reinstalling the metal plate, make sure that all rough surfaces have been removed. Remember to use the correct size gland.
-

REMINDER

1. The robot has passed the electromagnetic compatibility test specified in the international IEC standard. Interference signals higher than the level specified in IEC standards will cause abnormal behavior of the robot. Extremely high signal level or over exposure will cause permanent damage to the robot. EMC problems usually occur during welding and are usually prompted by error messages in the log. Suzhou ELITE Robot Co., Ltd (ELITE) is not responsible for any loss caused by EMC problems.
 2. The length of IO cable used to connect the controller with other mechanical and plant equipment shall not exceed 10m, unless it is feasible after extension test.
-

TIPS

All voltages and currents are DC (direct current) unless specified.

6.3 Electrical Interface of Controller

This section mainly describes all the electrical interfaces of the CS controller, including the external and internal electrical interfaces of the controller. The external electrical interface of the controller includes the cable interface between the controller and the AC power supply and robot arm; The internal electrical interface includes safety IO, remote switch, IO power supply, configurable IO, digital IO and analog IO.

6.3.1 External Electrical Interface

6.3.1.1 AC Power Interface

The robot AC power interface is located at the bottom of the controller. As shown in Figure 6-1 below, the power cord jack must be connected with standard plug (as shown in Figure 6-2 below). After the main power cable is correctly connected, the power on operation of the controller can be completed through the power switch.

6.3.1.2 Robot arm Cable Interface

The robot cable must be inserted into the connector at the bottom of the controller, as shown in Figure 6-3. Before powering on the robot, be sure to properly lock the connector. When disconnecting the robot cable, the power supply of the robot must be cut off to avoid injury to equipment or people.

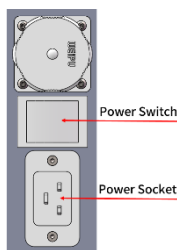

Figure 6-1 Power input socket



Figure 6-2 Standard power plug



Figure 6-3 Robot arm cable connector

REMINDER



1. Do not disconnect the robot cable when the robot arm is turned on.
2. Do not extend or modify the original cable.

6.3.2 Internal Electrical Interface

The description of internal electrical interface of the CS controller is shown in Figure 6-4.

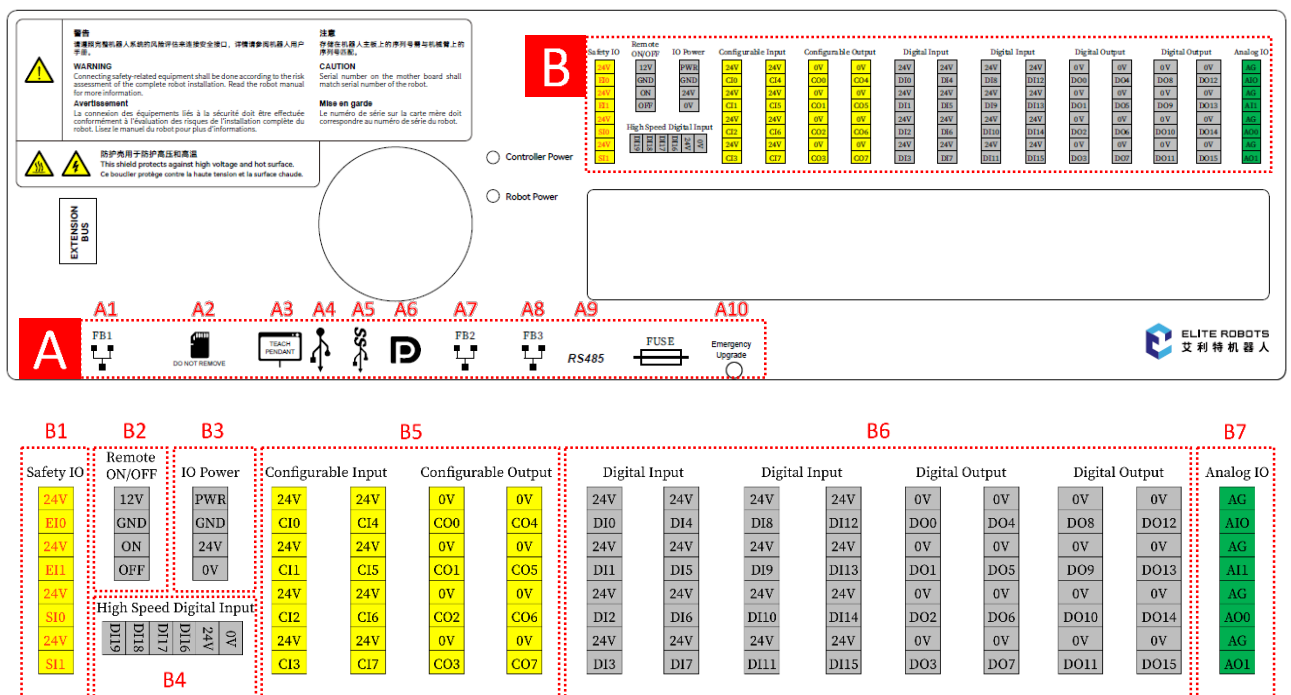

Figure 6-4 Schematic diagram of the internal electrical interface of the CS controller

Users can perform serial communication from the controller by connecting an RS485 device to the connector as shown in Figure 6-5. To set up the RS485 connector in the controller, please disassemble the serial port connector and weld the RS485 wires to the metal contacts on the back of the black connector (see Figure 6-6).

The front and back sides of the black plastic device are marked with PIN “1 3 5” and “2 4 6” respectively. PIN3 should be soldered to RS485B and PIN4 should be soldered to RS485A. The maximum supported baud rate of this interface is 500Kbps.

6 Electrical Interface

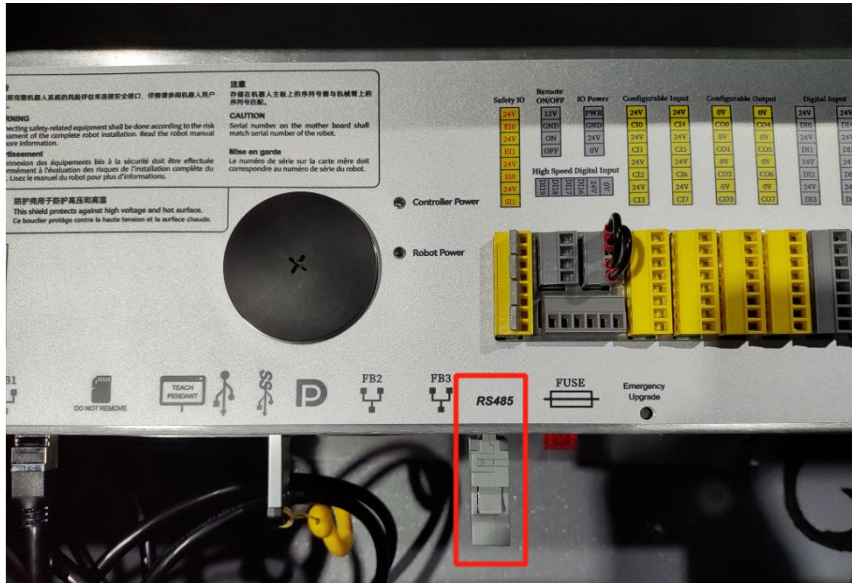

Figure 6-5 CS controller RS485 connector

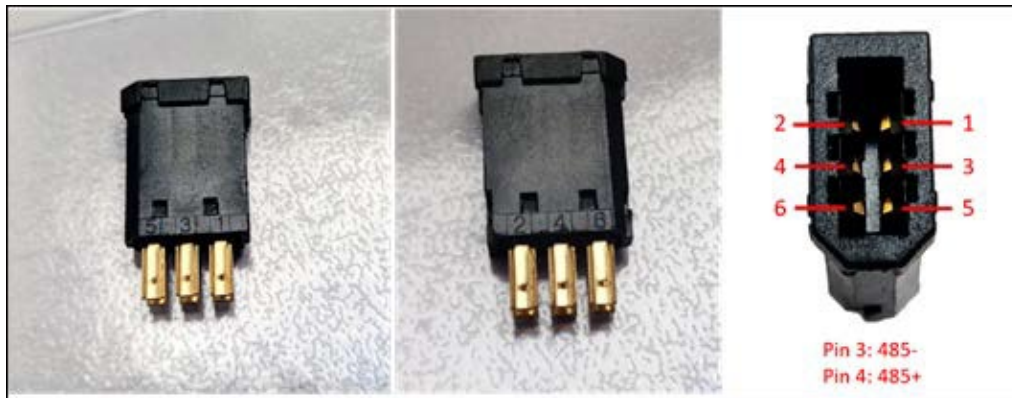

Figure 6-6 Black device

Table 6-1 Definition of the electrical interface area A inside the controller

Number	Definition	Function
A1	FB1 Gigabit Network Port	For connecting to the peripheral device, 10M / 100M / 1000M ethernet transmission
A2	SD Card Slot	For the reading of the SD card
A3	Teach Pendant Interface	For connecting to the robot teach pendant device
A4	USB 2.0 Interface	For system backup, program upload and download
A5	USB 3.0 Interface	For system backup, program upload and download
A6	Mini DP Interface	For connecting to the teach pendant
A7	FB2 100 Megabit Network Port	For connection to the peripheral device, the 10M / 100M Ethernet transmission
A8	FB3 100 Megabit Network Port	For connection to the peripheral device, the 10M / 100M Ethernet transmission
A9	RS-485 Interface	For connecting devices supporting the RS-485 protocol with a maximum baud rate of 500 Kbps
A10	System Upgrade Button for Emergency Cases	For system upgrades

Table 6-2 Color identification of internal interface area B of controller









Background Color	Text Color	Functional Differentiation
 Yellow	 Red	Special Safety IO
 Yellow	 Black	Configurable Safety IO
 Gray	 Black	General Digital IO
 Green	 Black	General Analog IO

Table 6-3 Definition of the electrical interface area B inside the controller

Number	Name	Terminal	Function
B1	Safety IO	24V } E10 }	When the external emergency stop switch is required, the external emergency stop switch can be connected to this terminal.
		24V } E11 }	

6 Electrical Interface

			Opening and closing of the 24VDC
		24V } SI0 }	When access to the peripheral safeguard devices is required, the external safeguard devices can be connected to this terminal.
		24V } SI1 }	When it is not necessary to access the peripheral protective equipment, the jumper wiring shall be installed.
			Opening and closing of the 24VDC
B2	Remote ON/OFF	12V	12V auxiliary power supply "+", 12V voltage constant supply
		GND	12V auxiliary power supply "-", 12V voltage constant supply
		ON	Open the "48V" power supply input terminal of the controller, and the activation time is: 200ms-600ms
		OFF	Close the "48V" power input terminal of the controller, which can be normally closed
B3	IO Power	PWR	24VDC output, internal power supply output terminal, power supply is grounded
		GND	
		24V	24VDC input, IO power supply input terminal, which is connected to the power supply output terminal (internal power supply) by default. If more current is required, the terminal can be connected to an external regulated power supply
		0V	
B4	High Speed Digital Input	0V	24VDC input, high-speed digital input port power supply terminal
		24V	
		DI16	High speed digital input 1
		DI17	High speed digital input 2
		DI18	High speed digital input 3
		DI19	High speed digital input 4
B5	Configurable Input/Output	24V } CI0 }	Configurable secure input connection 1
		24V } CI1 }	
		24V } CI2 }	Configurable secure input connection 2

		24V } CI3 }	
		24V } CI4 }	Configurable secure input connection 3
		24V } CI5 }	
		24V } CI6 }	Configurable secure input connection 4
		24V } CI7 }	
		0V	0V voltage power supply output terminal, the terminal has been short circuited internally
		CO0	Configurable safety output of 0
		CO1	Configurable safety output of 1
		CO2	Configurable safety output of 2
		CO3	Configurable safety output of 3
		CO4	Configurable safety output of 4
		CO5	Configurable safety output of 5
		CO6	Configurable safety output of 6
		CO7	Configurable safety output of 7
B6	Digital Input/Output	24V	24V voltage power supply output terminal, the terminal has been short circuited internally
		DI0	Digital input 0, MOSFET, PNP (active with high signal), 24VDC
		DI1	Digital input 1, MOSFET, PNP (active with high signal), 24VDC
		DI2	Digital input 2, MOSFET, PNP (active with high signal), 24VDC
		DI3	Digital input 3, MOSFET, PNP (active with high signal), 24VDC
		DI4	Digital input 4, MOSFET, PNP (active with high signal), 24VDC
		DI5	Digital input 5, MOSFET, PNP (active with high signal), 24VDC
		DI6	Digital input 6, MOSFET, PNP (active with high signal),

6 Electrical Interface

			24VDC
		DI7	Digital input 7, MOSFET, PNP (active with high signal), 24VDC
		DI8	Digital input 8, MOSFET, PNP (active with high signal), 24VDC
		DI9	Digital input 9, MOSFET, PNP (active with high signal), 24VDC
		DI10	Digital input 10, MOSFET, PNP (active with high signal), 24VDC
		DI11	Digital input 11, MOSFET, PNP (active with high signal), 24VDC
		DI12	Digital input 12, MOSFET, PNP (active with high signal), 24VDC
		DI13	Digital input 13, MOSFET, PNP (active with high signal), 24VDC
		DI14	Digital input 14, MOSFET, PNP (active with high signal), 24VDC
		DI15	Digital input 15, MOSFET, PNP (active with high signal), 24VDC
		0V	0V voltage power supply output terminal, the terminal has been short circuited internally
		DO0	Digital output 0, MOSFET, output is high, 24VDC
		DO1	Digital output 1, MOSFET, output is high, 24VDC
		DO2	Digital output 2, MOSFET, output is high, 24VDC
		DO3	Digital output 3, MOSFET, output is high, 24VDC
		DO4	Digital output 4, MOSFET, output is high, 24VDC
		DO5	Digital output 5, MOSFET, output is high, 24VDC
		DO6	Digital output 6, MOSFET, output is high, 24VDC
		DO7	Digital output 7, MOSFET, output is high, 24VDC
		DO8	Digital output 8, MOSFET, output is high, 24VDC
		DO9	Digital output 9, MOSFET, output is high, 24VDC
		DO10	Digital output 10, MOSFET, output is high, 24VDC
		DO11	Digital output 11, MOSFET, output is high, 24VDC
		DO12	Digital output 12, MOSFET, output is high, 24VDC

		DO13	Digital output 13, MOSFET, output is high, 24VDC
		DO14	Digital output 14, MOSFET, output is high, 24VDC
		DO15	Digital output 15, MOSFET, output is high, 24VDC
B7	Analog IO	AG	Analog power supply A_GND, the terminal has been short circuited internally
		AI0	Analog input 0, voltage 0~10V, current 4~20mA, resolution 12bit
		AI1	Analog input 1, voltage 0~10V, current 4~20mA, resolution 12bit
		AO0	Analog output 0, voltage 0~10V, current 4~20mA, resolution 12bit
		AO1	Analog output 1, voltage 0~10V, current 4~20mA, resolution 12bit

6.3.2.1 Safety IO

1. Use of Safety IO

Safety devices and equipment must be installed in accordance with safety instructions and risk assessment, see Chapter 1. All safety IO exist in pairs (redundant) and must be retained as two independent branches. A single failure will not result in loss of safety function. There are two fixed inputs: emergency stop and protective stop. The emergency stop input is only used for emergency stop equipment. The safeguard stop input can be used for all types of safety protection equipment. The functional differences are shown in Table 6-4. The user can also use the configurable IO to set other safety IO functions such as emergency stop output.

Table 6-4 Difference between emergency stop and protective stop

	Emergency Stop	Safeguard Stop
The robot stops moving	Yes	Yes
Task execution	Stop	Pause
Robot power supply	Close	Open
Resetting	Manual	Automatic or manual
Operating frequency	Not often used	No more than once per run cycle
Downtime category (IEC 60204)	1	2
Performance level (ISO 13849-1)	PLd	PLd

DANGER

1. Do not connect the safety signal to the non-safety IO with improper safety level. Failure to comply with this warning may result in serious injury or even death due to the failure of a safety stop function. Be sure to separate the safety interface signal from the ordinary IO interface signal.
2. All safe IO have redundancy (two independent channels). Keeping the two channels independent ensures that the safety function will not be lost in the event of a single failure.
3. Before putting the robot into use, be sure to check the safety function. Safety functions must be tested regularly.

2. Default safety IO Configuration

The safety IO is connected by default in the controller, which can be operated without any additional safety equipment (the emergency stop button of the teach pendant remains valid). The wiring is shown in Figure 6-6 below.

3. Connect the External Emergency Stop Button

When one or more external emergency stop buttons are required, all emergency stop buttons can be connected in series, as shown in Figure 6-7.

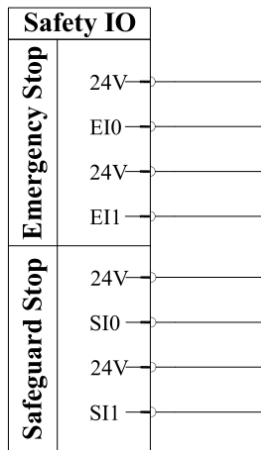

Figure 6-6 Safety IO Connection for Default Configuration

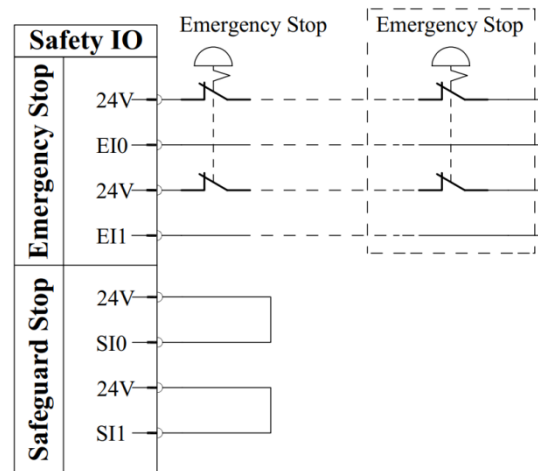

Figure 6-7 Connection for External Emergency Stop Buttons

4. Connection for Safeguard Stop

The safeguard stop only takes effect in PLAY mode. The robot safeguard stop mode can be configured according to the characteristics of the safeguard device (whether it can be automatically restored): automatic recovery mode and safeguard reset mode.

(a) Automatic Recovery Mode

When it is necessary to connect an automatically recoverable safeguard stop, the wiring method is shown in Figure 6-8 below. Take the safety door lock as an example. When the door is opened, the door lock signal is always disconnected until the safety door is closed again and the safety door lock signal is restored. When the safety door lock is opened, the robot will also stop moving. After ensuring that the operator has left the safety safeguard area, reclose the safety door lock, and the robot can automatically resume its movement.

DANGER



When the safeguard signal is restored, the robot automatically resumes its motion. Do not use this configuration if the signal can be restored inside the safety zone.

(b) Safeguard Reset Mode

Using the safety light curtain as an example, the light curtain broken signal is generated only when an object passes through, the robot safeguard signal disconnects accordingly. After

6 Electrical Interface

the object passing through, the light curtain automatically recovers, the broken signal disappears, the robot safeguard signal is restored. Therefore, it is necessary to configure the safeguard reset mode to ensure that the personnel have left the safeguard area and reset the robot system outside the area to restore the robot movement.

When using the safety light curtain, it is necessary to convert the digital signal of the light curtain into a double normally closed circuit and then connect it to the safety IO terminal. Its connection mode is shown in Figure 6-8. The reset of the system after preventing the reconstruction of the stop signal can be realized by the button, but the reset button must be dual channel type, and its connection mode is shown in Figure 6-9.

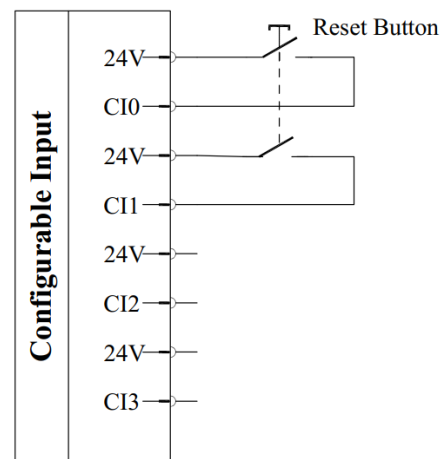
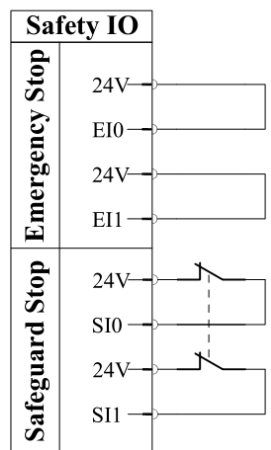

Figure 6-8 Connection of protective stop device Figure 6-9 Reset button connection

6.3.2.2 Remote Switch

Remote switch enables power on and off the robot controller without teach pendant. It is usually used for the following situation:

- The teach pendant is inaccessible;
- The PLC system implements the full control;
- Multiple robots must be turned on or off simultaneously.

The remote ON / OFF functional terminal provides a 12V auxiliary power supply. The 12V auxiliary power terminal of the functional terminal will remain charged when the main power is on and the controller is off.

The remote ON input is only for short activation and works in the same way as the POWER button. Hold down the OFF input if necessary.

Note: There are functions in the software to automatically load and start tasks for user to use.

2. Remote Switch Electrical Specifications

Table 6-5 Remote switch electrical specifications

Terminal	Parameter	Minimum Value	Typical Value	Maximum Value
12V-GND	Voltage	10V	12V	13V
	Electric current	-	-	100mA
ON/OFF	Passive voltage	0V	-	0.5V
	Active voltage	5V	-	12V
	Input current	-	1mA	-
	Activation time	200ms	-	600ms

3. Remote ON/OFF Wiring

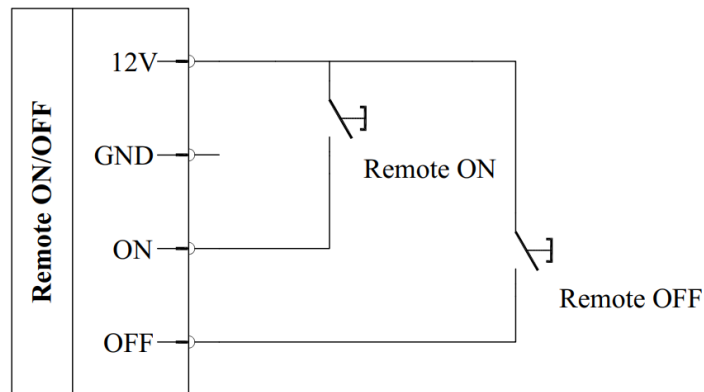

Figure 6-10 Remote ON/OFF wiring

DANGER



The OFF input must be used for remote shutdown control because this signal allows the controller to save open files and close them normally.

6.3.2.3 IO Power Supply

The digital IO of CS Series controller can be powered by internal 24V power supply or by external power supply through the configuration of power terminal.

Use internal power supply, refer to Figure 6-11 terminal connection mode.

For external power supply, refer to Figure 6-12 terminal connection mode.

Where "PWR" is the 24V positive pole of internal power supply, "GND" is the negative pole of internal power supply, "24V" is the positive pole of all general digital IO, "0V" is the negative pole of all digital IO. The default configuration of CS series controller is internal power supply.

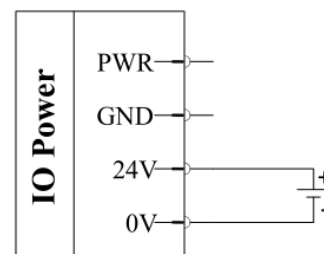
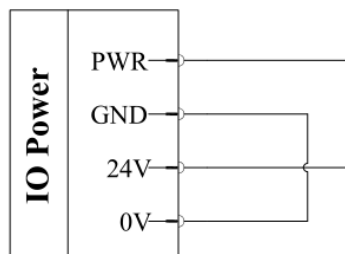

Figure 6-11 Use internal power wiring mode Figure 6-12 Use external power wiring mode

The electrical specifications of IO power supply are shown in Table 6-6 below.

Table 6-6 IO power electrical specifications

Terminal	Parameter	Minimum Value	Typical Value	Maximum Value
Built-in Power Supply	Voltage	22.8V	24V	25.2V
	Electric current	0A	-	3A
External Power Supply	Voltage	20V	24V	30V
	Electric current	0A	-	6A

6.3.2.4 Configure IO

The CS Series controller includes 8 groups of configurable inputs and 8 groups of configurable outputs, as shown in area B5 in Figure 6-4 above. Users can define the functions of configurable IO through the teach pendant.

1. Configure IO Setting

Configurable input can be set to: start task, stop task, pause task and drag mode.

Configurable output can be set to: minimum when not running, maximum when not running, maximum when running - minimum when stopping and continuous pulse when running.

2. Configure IO Electrical Specifications

Table 6-7 Configure IO electrical specifications

Terminal	Parameter	Minimum Value	Typical Value	Maximum Value
Configurable Output	Output voltage	-1V	24V	30V
	Load capacity	0A	-	1.4A
	Pressure drop(0.5A)	-	75mV	-
	Leakage current	0mA	-	0.1mA
	IEC 61131-2	-	TYPE 3	-
Configurable Input	Input voltage	-0.3V	24V	30V
	OFF area	-2V	-	2V
	ON area	8V	24V	30V
	Electric curren	2mA	-	8.5mA
	OEC 61131-2	-	TYPE 3	-

3. Configure IO Wiring Mode

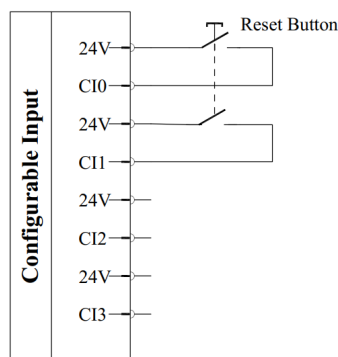

Figure 6-13 Configure input wiring mode

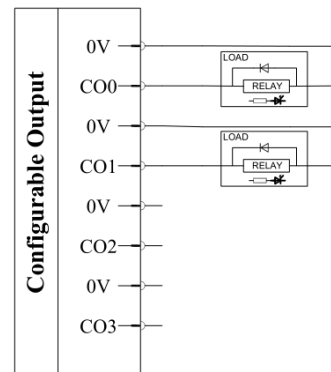

Figure 6-14 Configure output wiring mode

6.3.2.5 Digital IO

The CS Series controller supports 16 digital inputs and 16 digital outputs. It can be used to input or output digital signals, as shown in B6 area of Figure 6-4.

1. Digital IO Electrical Specifications

Table 6-8 Digital IO electrical specifications

Terminal	Parameter	Minimum Value	Typical Value	Maximum Value
Digital output	Maximum Load Current of Single Output Port	-	-	1.4A
	Total Maximum Load Current of Output Port	-	-	3A
	Output Voltage	22.8V	24V	25.2V
Digital input	Input Voltage	-3V	24V	30V
	OFF Area	-2V	-	2V
	ON Area	8V	24V	30V
	Electric Current	2mA	-	8.5mA

2. Wiring Instructions for Using Internal Power Supply

1) Digital input wiring mode

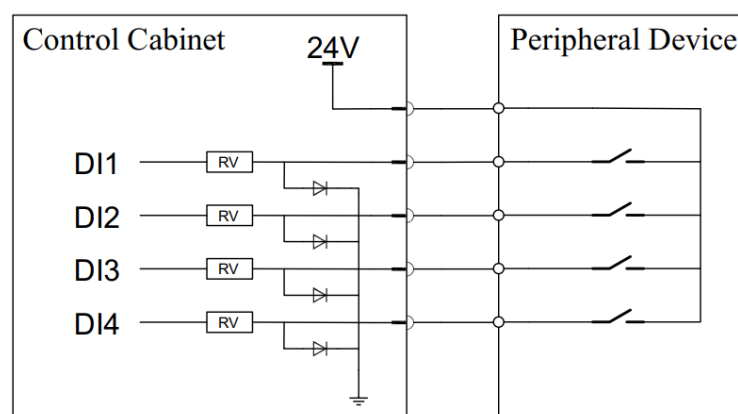

Figure 6-15 Digital input wiring mode

2) Digital output wiring mode

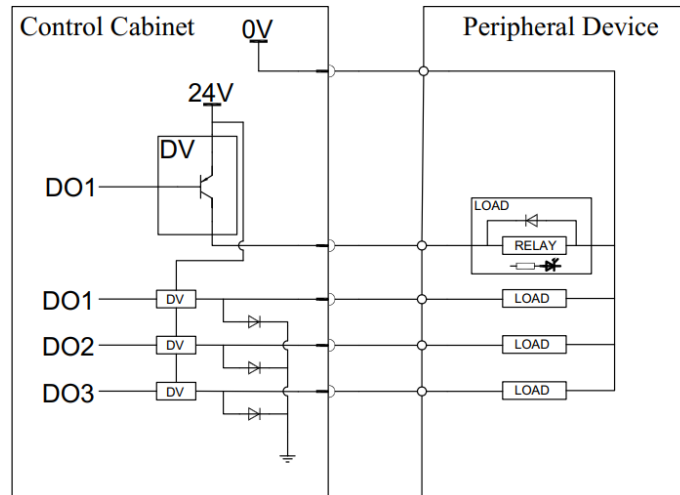

Figure 6-16 Digital output wiring mode

3. Use external regulated power supply for power supply and digital input and output wiring mode

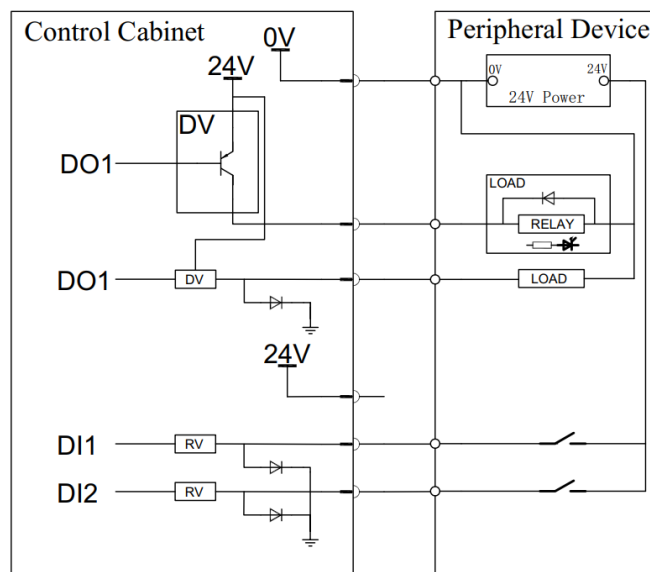

Figure 6-17 Digital I/O connection mode

REMBDER The input device used to start automatic operation must be installed outside the safe space.



All 24V and 0V terminals have been short circuited internally and can be used arbitrarily.

6.3.2.6 Analog IO

The analog IO interface can be used to receive / send analog signals (voltage (0V ~ 10V) or current (4mA ~ 20mA)). For high accuracy, the following instructions are recommended:

- Use the "GNDPA" terminal closest to this IO. Ensure that the signal terminal and terminal share the same filter;
- The equipment and controller use the same grounding (0V). There is no potential isolation between analog IO and controller;
- Use shielded cable or twisted pair. Connect the shielded wire to the "GNPD" terminal on the "Power" terminal.

1. Analog IO Electrical Specifications

Table 6-9 Analog IO electrical specifications

Terminal	Parameter	Minimum Value	Typical Value	Maximum Value
Current Mode: Analog Input Aix - AG	Electric Current	4mA	-	20mA
	Resistance	-	20kΩ	-
	Resolution	-	12bit	-
Voltage Mode: Analog Input Aix - AG	Voltage	0	-	10V
	Resistance	-	10kΩ	-
	Resolution	-	12bit	-
Current Mode: Analog Output AOx - AG	Electric Current	4mA	-	20mA
	Voltage	0V	-	24V
	Resolution	-	12bit	-
Voltage Mode: Analog Output AOx - AG	Voltage	0V	-	10V
	Electric Current	4mA	-	20mA
	Resistance	-	1Ω	-
	Resolution	-	12bit	-

2. Analog IO Connection Mode

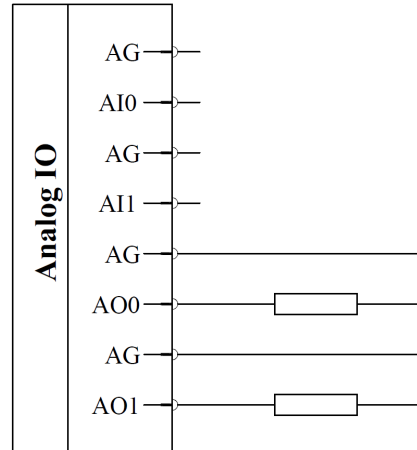
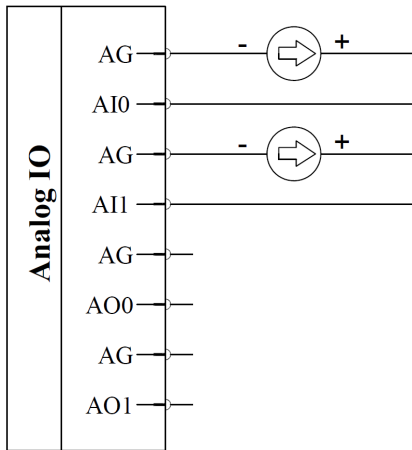

Figure 6-18 Analog input connection mode Figure 6-19 Analog output connection mode

6.3.2.7 Mini DP Interface

The Mini DP interface is a kind of DP interface. Both of them have the same function and are used for data transmission, but the Mini DP interface is smaller. Mini DP interface can be externally connected to display screen, computer, projector and other equipment, and supports hot plugging during use, as shown in Figure 6-20.

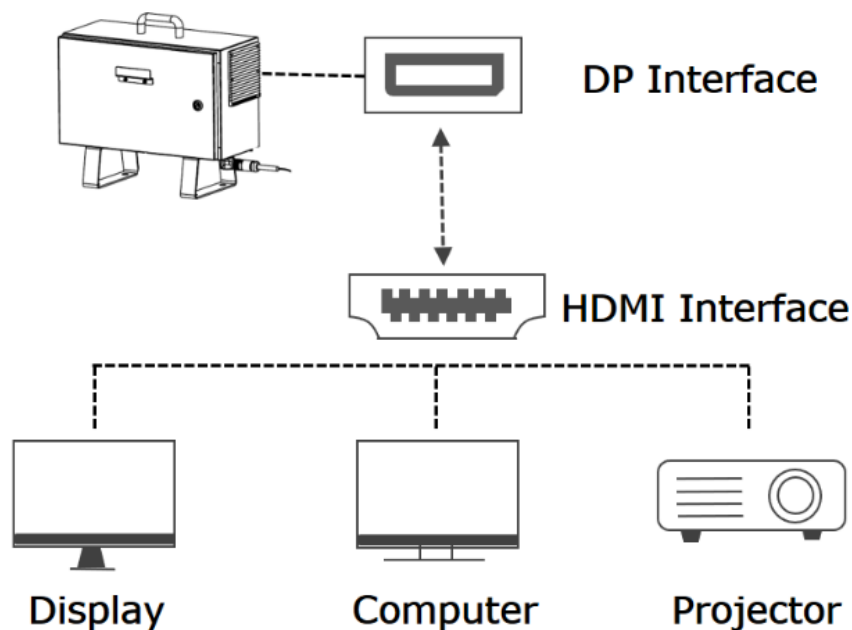

Figure 6-20 Mini DP Interface

6.4 Teach Pendant Electrical Interface

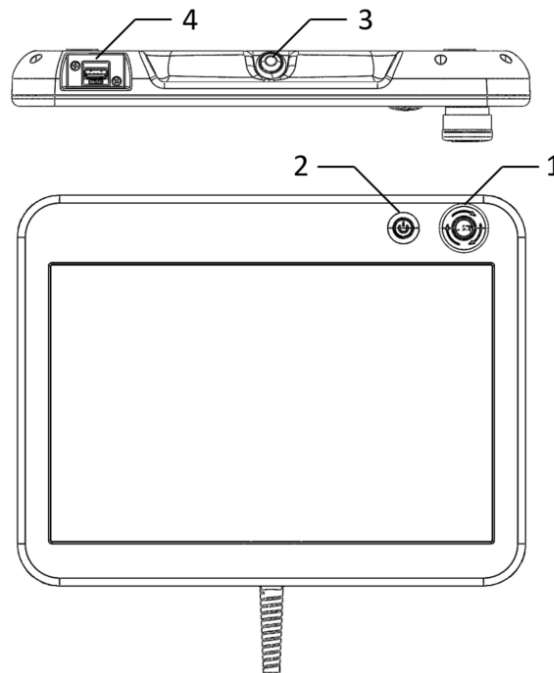

Figure 6-21 Teach pendant electrical interface

Table 6-10 Digital definition of teach pendant electrical interface

Number	Interface	Function
1	Emergency Stop Button	The default safety configuration is valid
2	Start Button	Press to start the controller, long press to forcibly shut down
3	Enable Button	Drag the teach enable button
4	USB Interface	USB3.0 interface

6.5 Robot Arm Electrical Interface

This section mainly introduces the electrical interface contained in the CS robot arm, which includes the cable of the arm and terminal IO.

6.5.1 Robot Arm Base Electrical Interface

On the cable of the robot arm, there is a plug at the end. Please plug it into the robot controller. Be careful about the direction of the connector, and lock connector properly after plugging in, as shown in Figure 6-22.

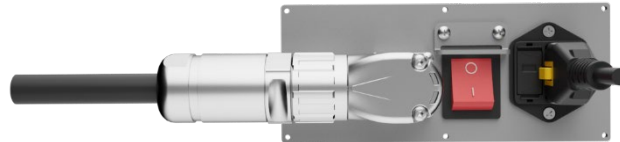

Figure 6-22 The robot cable is connected to the controller

6.5.2 Robot Arm Tool End IO Interface

There is a cylindrical metal knob cover next to the tool flange at the end of the robot. Remove the cover on the tool flange to see the 8-pin IO port, which can provide power and control signals for the gripper, sensor and other devices connected to the robot terminal IO, as shown in Figure 6-23. The aviation plug of IO interface at the robot tool end is shown in Figure 6-24, and the aviation plug welding wire of the user is shown in Figure 6-25. The definition and function of IO pin at the tool end are shown in Table 6-11.

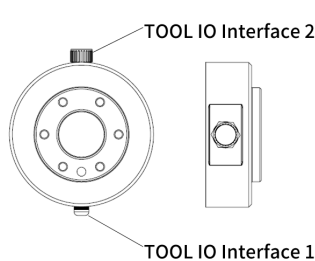

Figure 6-23 Robot terminal IO

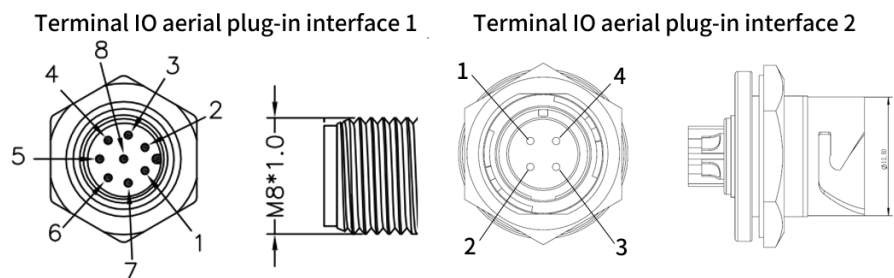

Figure 6-24 Robot terminal IO aerial plug-in interfaces

6 Electrical Interface

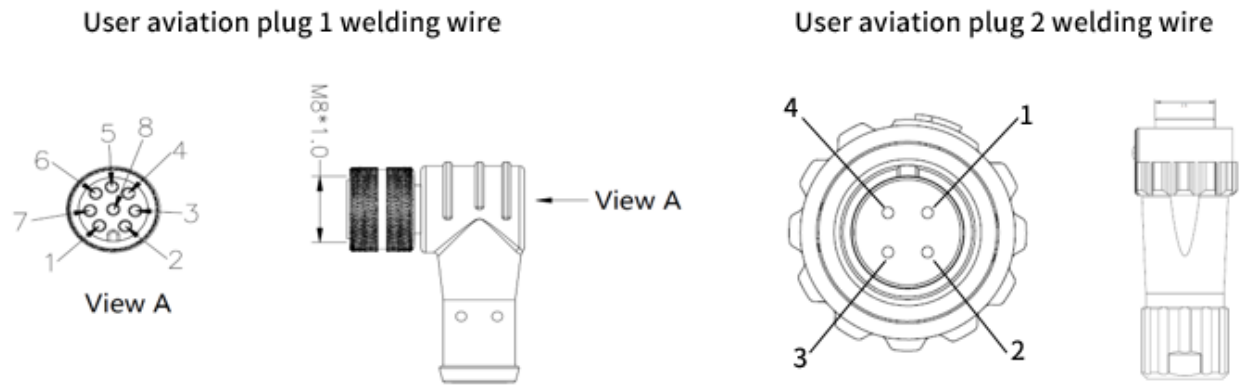

Figure 6-25 The user aviation plug welding wires

Table 6-11 Terminal IO 1 definition

Pin Number	Cable Color	Signal Name	Signal Description
1	White	AI2/ RS485+	Analog input 2 or RS485+
2	Brown	AO2/RS485-	Analog output 2 or RS485-
3	Green	TI3/TO3/PWR2	Digital input 3 or digital output 3 or 0V/12V/24V
4	Yellow	TI2/TO2/GND2	Digital input 2 or digital output 2 or ground
5	Gray	POWER	0V/12V/24V
6	Pink	TI0/TO0/GND1	Digital input 0 or digital output 0 or ground
7	Blue	TI1/TO1/PWR1	Digital input 1 or digital output 1 or 0V/12V/24V
8	Red	GND	Ground wire

Table 6-12 Terminal IO 2 definition

Pin Number	Cable Color	Signal Name	Signal Description
1	Brown	POWER	24V
2	Green	GND	0V
3	Red	CAN_L	CAN communication : CAN_L
4	Black	CAN_H	CAN communication : CAN_H

6.5.2.1 Tool Power Supply

The tool IO interface 1 can provide 0V, 12V or 24V power supply to external tools and the tool IO interface 2 can provide 24V power supply, which can be set in the IO tab of the user interface of the teaching pendant. The detailed electrical specifications are as shown in Table 6-13.

Table 6-13 Tool power electrical specifications

Tool IO interface 1				
Parameter		Min. value	Typical value	Max. value
Supply voltage	24V mode	22.8V	24V	25.2V
	12V mode	11.4V	12V	12.6V
Supply current	Single pin	-	1000mA	2000mA
	Dual pin	-	2000mA	2000mA
	Three pin	-	3000mA	3000mA
Supply power capacitive load		-	-	800 μ F
Tool IO interface 2				
Parameter		Min. value	Typical value	Max. value
Supply voltage	24V mode	22.8V	24V	25.2V
Supply current	-	-	-	5A
Supply power capacitive load*		-	-	800 μ F

*Note: For the supply power capacitive load, the tool IO 2 does not allow the user to make any hotplug actions.

1. Single pin power mode

The configuration method is as follows:

1) Under the condition that the current meets the demand, the single pin power supply mode can be selected to avoid occupying other IO interfaces and increase the number of controllable external components

2) Wiring method: as shown in Figure 6-26.

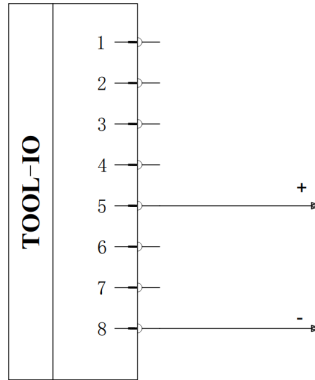

Figure 6-26 Single pin power mode wiring

2. Dual pin power mode 1

The configuration method is as follows:

1) System configuration: select "Config > General > Tool IO", and select "Dual Pin Mode 1".

2) Wiring method: as shown in Figure 6-27 below, connect the power cable (5 gray) with TI3/TO3/PWR2 cable (3 green), and the grounding cable (8 red) with TI2/TO2/GND2 cable (4 yellow).

3. Dual pin power mode 2

The configuration method is as follows:

1) System configuration: select "Config > General > Tool IO", and select "Dual Pin Mode 2".

2) Wiring method: as shown in Figure 6-28, connect the power cable (5 gray) to the TI1/TO1/PWR1 cable (7 blue), and the ground cable (8 red) to the TI0/TO0/GND1 cable (6 pink).

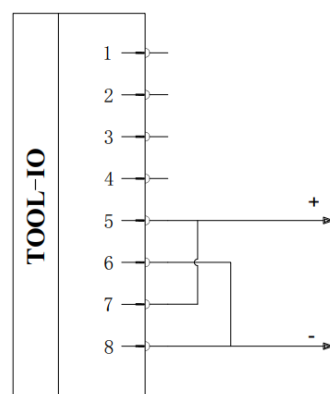
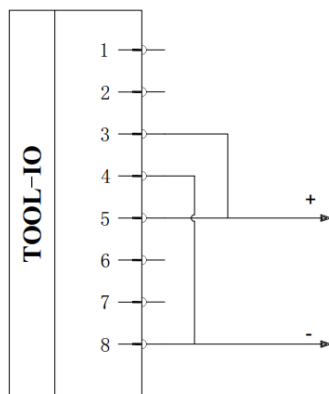

Figure 6-27 Dual pin mode 1 connection Figure 6-28 Dual pin mode 2 connection

REMINDER 1. When using inductive loads, freewheeling diodes are recommended.



2. Under the dual pin power supply mode, the maximum current is 2000mA, the maximum duration is 1s, and the maximum duty cycle is 10%. The average current shall not exceed 1000mA.

4. Three pin power mode

In three pin power mode, refer to Table 6-13 for the electrical specifications. The configuration is as follows:

1. System configuration: select "Config > General > Tool IO", select "Three Pin Mode", and in the three digit enable mode;

2. Wiring method: as shown in Figure 6-29, connect the power cable (5 gray) with T11/TO1/PWR1 cable (7 blue) and T13/TO3/PWR2 cable (3 green), and the grounding cable (8 red) with T10/TO0/GND1 cable (6 pink) and T12/TO2/GND2 cable (4 yellow).

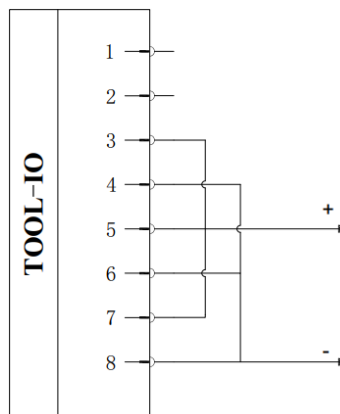

Figure 6-29 Three pin power mode

6.5.2.2 Tool Digital Output

Digital output supports three different modes, as shown in Table 6-14:

Table 6-14 Three modes of digital output

Mode	Trigger Mode	Inactive
NPN(sinking)	Low level	High resistance grounding
PNP(pure source)	High level	High resistance grounding
Push / pull	High level	High resistance grounding

Schematic diagram of digital output port circuit

1. NPN mode

The output interface is NPN type output and supports 1000mA current inflow. The wiring mode is shown in Figure 6-30 NPN mode (single pin power supply mode).

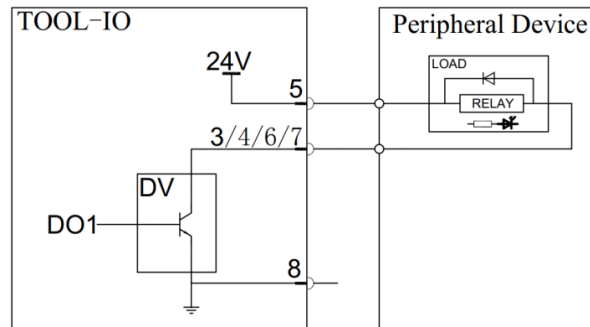

Figure 6-30 NPN mode

Suggestion: use protective diode for inductive load, otherwise the port may be damaged.

2. PNP mode

The output interface is PNP type output and supports 1000mA current outflow. The wiring mode is shown in Figure 6-31 PNP mode (single pin power supply mode).

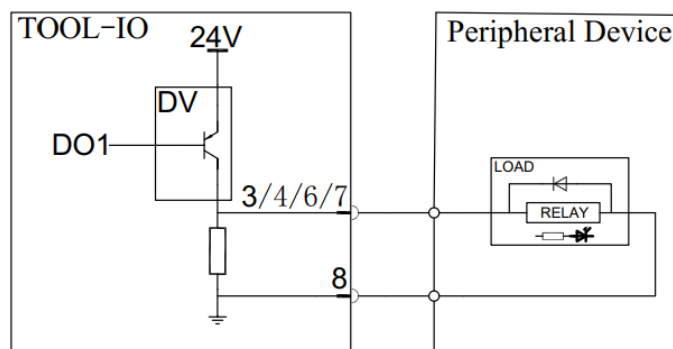

Figure 6-31 PNP mode

3. Push / pull mode

The output interface can be connected according to PNP type output wiring, as shown in Figure 6-32, or NPN type wiring, as shown in Figure 6-33, supporting 1000mA current outflow (PNP) or inflow (NPN).

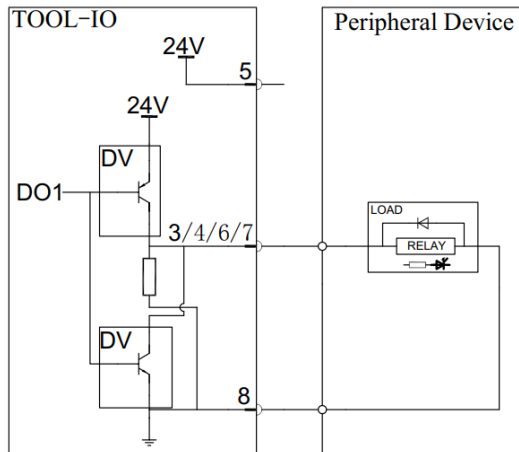

Figure 6-32 PNP mode wiring

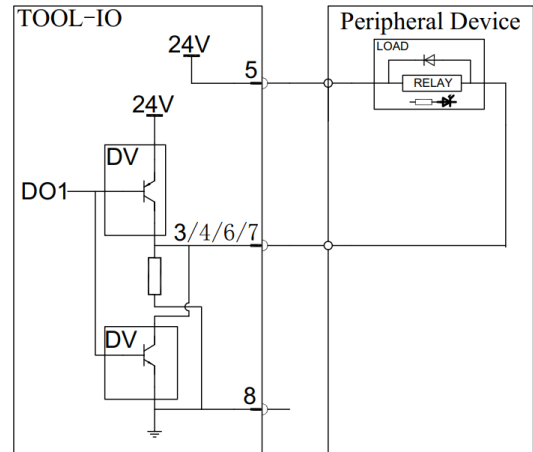

Figure 6-33 NPN mode wiring

6.5.2.3 Tool Digital Input

The digital input is implemented in the form of a PNP with a weak pull-down resistor. This means that the reading of the floating input is always low. The electrical specifications are shown in Table 6-15, and the wiring method is shown in Figure 6-34.

Table 6-145 Tool digital input electrical specifications

Parameter	Minimum Value	Typical Value	Maximum Value
Input voltage	-0.5V	-	26V
Logic low level	-	-	2V
Logic high level	5.5V	-	-
Input impedance	47kΩ	-	-

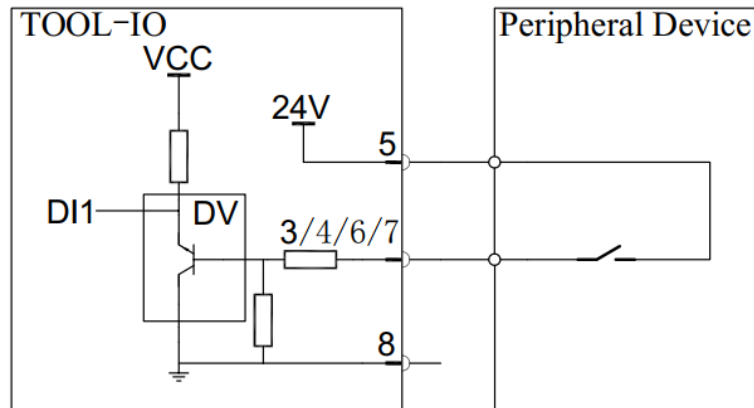

Figure 6-34 Tool digital input wiring method

6.5.2.4 Tool Analog Input

Table 6-16 Tool analog input electrical specifications

Parameter		Minimum Value	Typical Value	Maximum Value
Voltage mode	Input voltage	-0.5V	-	26V
	0-10V input resistance	-	-	10.7kΩ
	Resolution	-	12bit	-
Current mode	Input voltage	-0.5V	-	5V
	Input current	-2.5mA	-	25mA
	4-20mA input resistance	-	182Ω	188Ω
	Electric resolution	-	12bit	-

1. Tool analog input (non-differential)

The voltage range of analog input is (0-10V) and the current range is (4-20mA). The wiring method is shown in Figure 6-35 below. As long as the input mode setting of the analog input is the same as that in the IO tab, the output of the sensor can be set to current mode or voltage mode.

2. Tool analog input (differential)

This example illustrates an analog sensor connection with a differential output. Connect the negative output terminal to GND (0V) to work like a non differential sensor. The wiring method is shown in Figure 6-36.

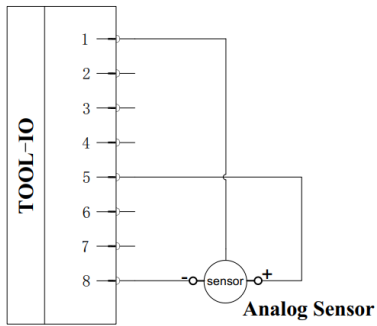

Figure 6-35 Analog input (non-differential) connection

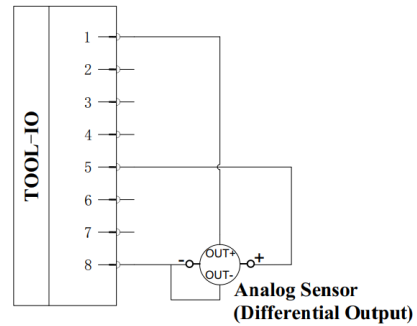

Figure 6-36 Analog input (differential) connection

6.5.2.5 Tool Analog Output

The tool analog output is non-differential output. The electrical specifications are shown in Table 6-17.

Table 6-17 Tool analog output electrical specifications

Parameter		Minimum Value	Typical Value	Maximum Value
Current mode	Output current	4mA	-	20mA
	Output voltage	0	-	12V
	Resolution	-	12bit	-
Voltage mode	Output voltage	0V	-	10V
	Output current	-20mA	-	20mA
	Output resistance	-	1Ω	-
	Resolution	-	12bit	-

The following is an example of how to use analog output: use tool analog output. This example illustrates the analog signal connection method with non differential output, as shown in Figure 6-37.

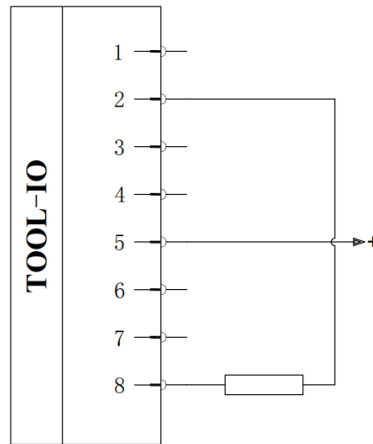

Figure 6-37 Analog output (non-differential) connection

6.5.2.6 Tool Communication IO

To use the RS485 port at the end to communicate with the actuator, it needs to be configured in the teach pendant Tool IO interface. Under Tool Analog IO section, choose USART Mode for Work Mode, and set parameters such as the baud rate based on the actual actuator parameters.

There is a delay around 2ms to 4ms between writing the data on the robot controller and sending data with RS485. The delay between receiving the data with RS485 and processing on robot controller is around 2ms to 4ms as well.

6.5.2.7 Running Status Light

The end of the robot is equipped with multi-color status lights, and different signal lights represent different modes and states. The specific description of light band control is shown in Table 6-18 below.

Table 6-18 Definition of light band control

Operation	State	Mode	Signal Lamp 1	Signal Lamp2
Drag mode		-	Blue always bright	-
Manual mode		Normal	Green always on	-
		Reduce	Green always on	Blue flashing
Task status	Run	Normal	Green always on	-
		Reduce	Green always on	Blue flashing
	Pause	-	Green flash	-
	Stop	-	Green slow flash	-
Protective stop		-	Yellow always bright	-
Emergency stop		-	Red always bright	-
Error	Alarm status	-	Red flash	-

Part III Robot Software Operation

7 Software Overview

Elite robot provides convenient programming methods, users only need a small amount of programming knowledge to program CS series of robots. CS robot software is using python based scripting language. With the workflow graphical interface, users can build task based on modular programming tree, which greatly improve programming efficiency.

Note: The pictures of the following settings are for reference only.

Users can use the teach pendant to operate robots and perform tasks. The main functions of the teach pendant are shown in Figure 7-1.

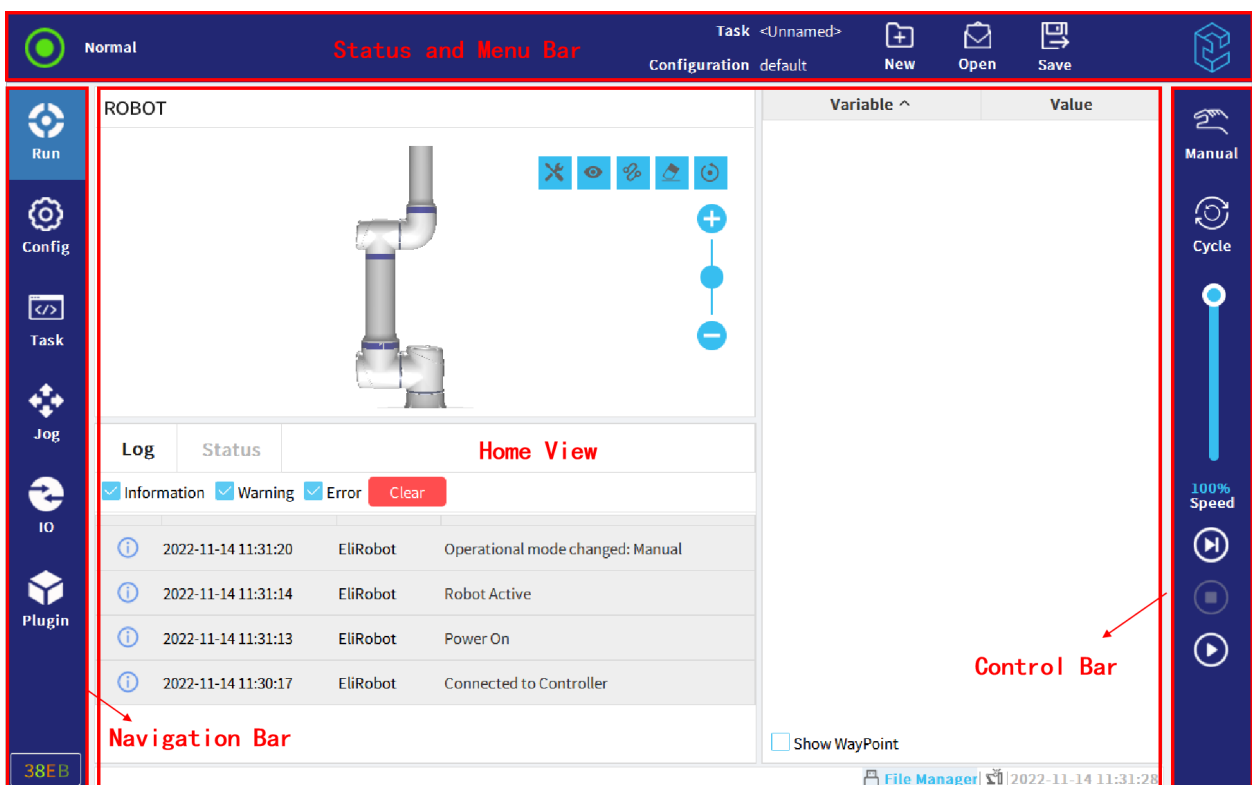

Figure 7-1 Screen division diagram

- **Status and Menu Bar:** users can view the current mode of the robot and manage tasks and configuration files;
- **Navigation Bar:** the user can choose to open the robot configuration, operation, IO and other tabs;
- **Control Bar:** the user can control the operation status, speed and mode of the current task of the robot;
- **Home View:** the user can view the robot status and operate the robot.

7 Software Overview

The following is a brief description of each function column of the teach pendant:

1. Status and Menu Bar

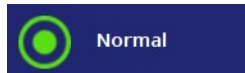

Displays the current mode of the robot.

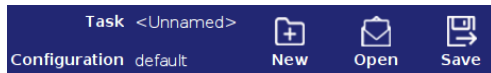

Manage task files and profiles.



System menu, view robot information, configure system parameters and shut down.

2. Navigation Bar



Configure robot parameters, including general parameters, safety parameters, bus communication functions and configuration plugins.



Insert task nodes into the task tree to create and manage tasks, including basic nodes, advanced nodes and task plugin nodes.



Control the robot to carry out joint motion or tool translation and rotation motion in the specified frame, and view the robot's pose.



View the real-time status of IO and modify the status of output io.



Check the status and log of the robot and monitor the global variables in the current running task.



Using the menu bar plugin.

3. Control Bar



Manual or automatic mode. To switch to manual mode, the user needs to enter the mode password.



Single or cyclic mode, click to switch mode.



Display and adjust the running speed percentage of the robot in real time.



Start or pause the currently running task of the robot.



Step through the current task.



Stop the currently running task of the robot.

8 Status and Menu Bar

This chapter mainly describes the CS620 robot state, task and configuration manager general operation instructions. This includes how to power on the robot, set up the payload, and how to create, open, and save tasks and configuration files.

8.1 Robot Status

The upper left corner of the status and menu bar indicates the status of the robot. Common robot states are as follows:

- Normal or reduced: the robot is in normal or reduced mode.
- Protective stop: the robot is in a protective stop state.
- Alarm: when the robot system fails.
- Starting: in the process of releasing the holding brakes.
- No controller: when eliserver service is not detected.
- Power off or power on: turn off or turn on the power of the robot.
- Idle: when the power is turned on but the holding brakes are not released.
- Running: when the robot is moving.
- Paused: when the robot task is paused.
- Free drag: press and hold the free drive button on the back of the teach pendant or click "drag" on the operation tab.
- Servo alarm: when servo communication fails.

8.1.1 Turn on Robot Power

The steps to turn on the power of the robot are as follows:

1. Click  in the upper left corner of the status and menu bar to enter the "Robot Status" page.
2. Click "Power On", the robot will be standby.
3. Click "Brakes Release" to enable operating the robot.

Note: When the joints are not in precise (to be calibrated), the joint calibration page will appear. In the page, the user can view which joints are not in precise. Click the "Auto Calibration" button and the joints that are not in precise will be automatically calibrated. The user can also calibrate those joints by clicking the left and right arrows. Once all joint calibrations are complete, click the "Exit" button below the "Auto Calibration" button to exit the current joint calibration page, as shown in Figure 8-1.

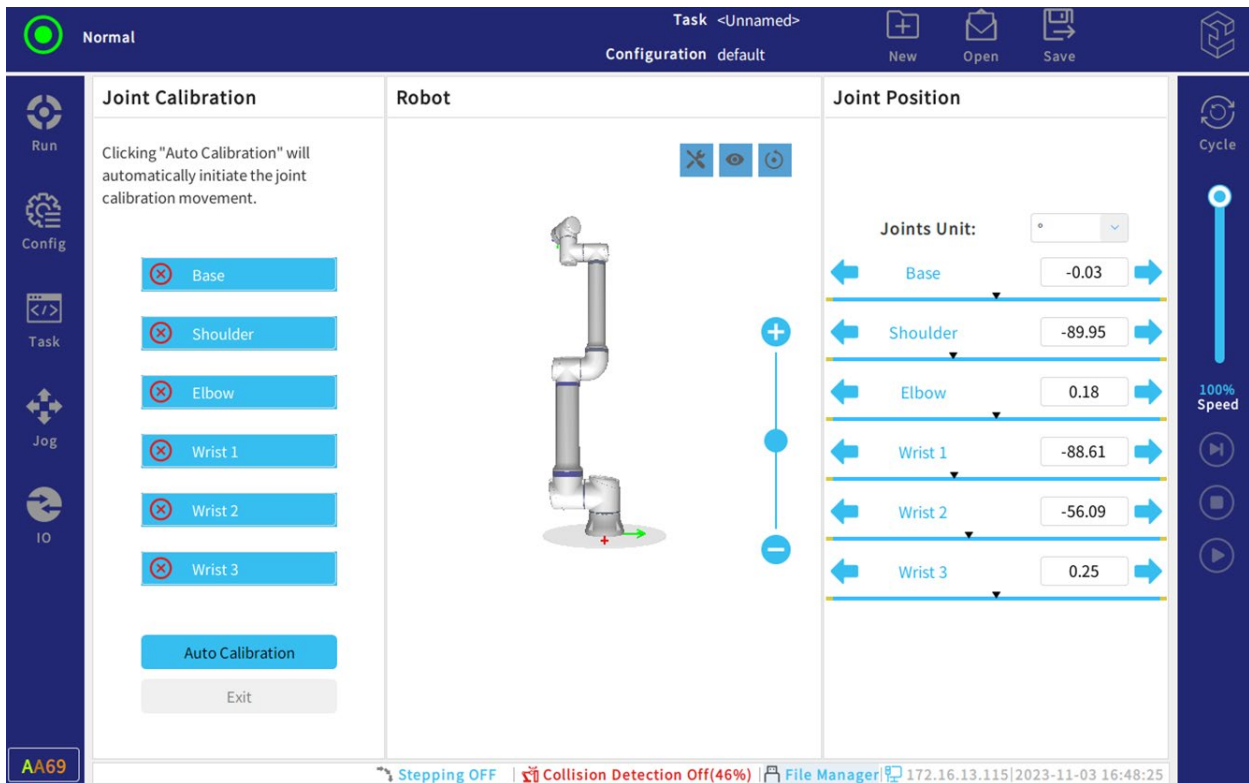

Figure 8-1 Joint calibration page

TIPS



1. The joint calibration page will not appear when the robot is in the remote or reset mode and the joints are not in precise. The system will automatically calibrate the joints.
2. Click Settings -> General Config and select "Open" or "Close" to enable or disable the joint auto-calibration function. The default is "Open". The user can select "Close" in accordance with the scenarios for purpose of decreasing the amplitude of the robot when releasing the brake.

4. Click "Exit" at the bottom left to exit the current page, as shown in Figure 8-2.

8 Status and Menu Bar

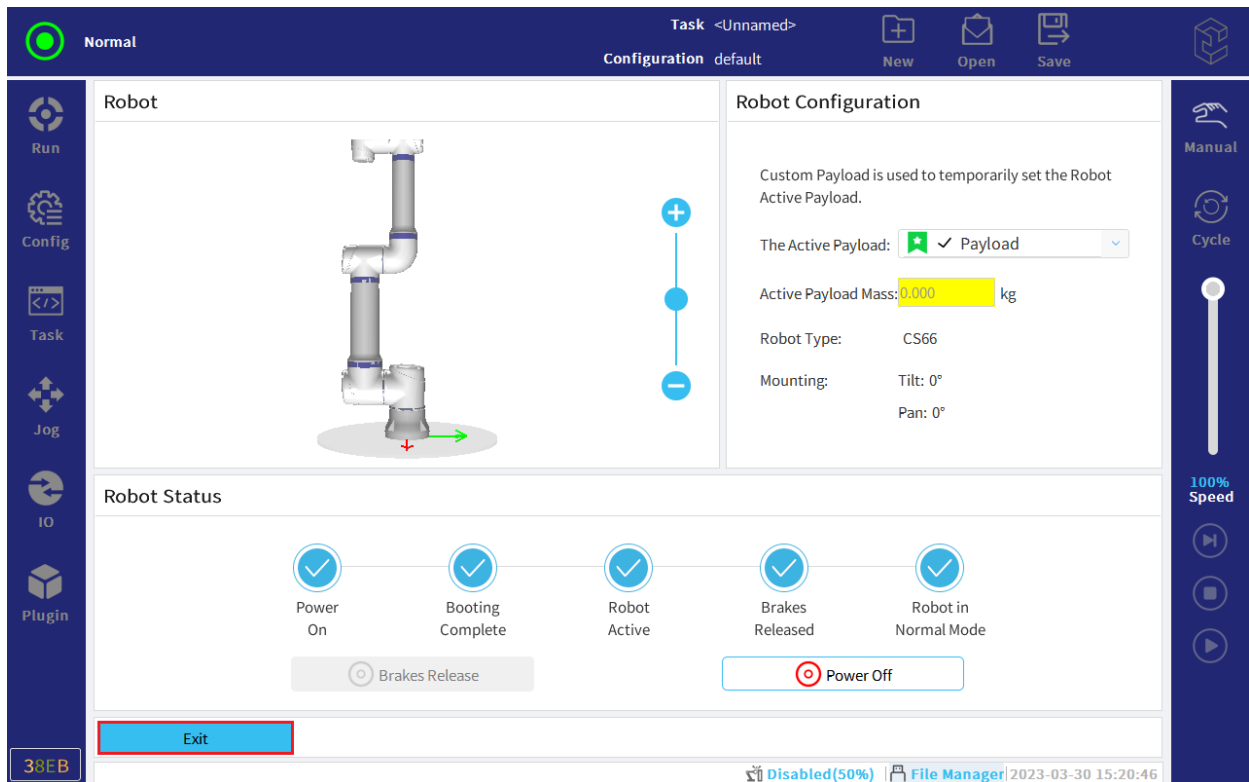

Figure 8-2 Exit the page

8.1.2 Setting Payload

The user can set the payload actually used by the robot under "Robot Configuration", as shown in Figure 8-3.

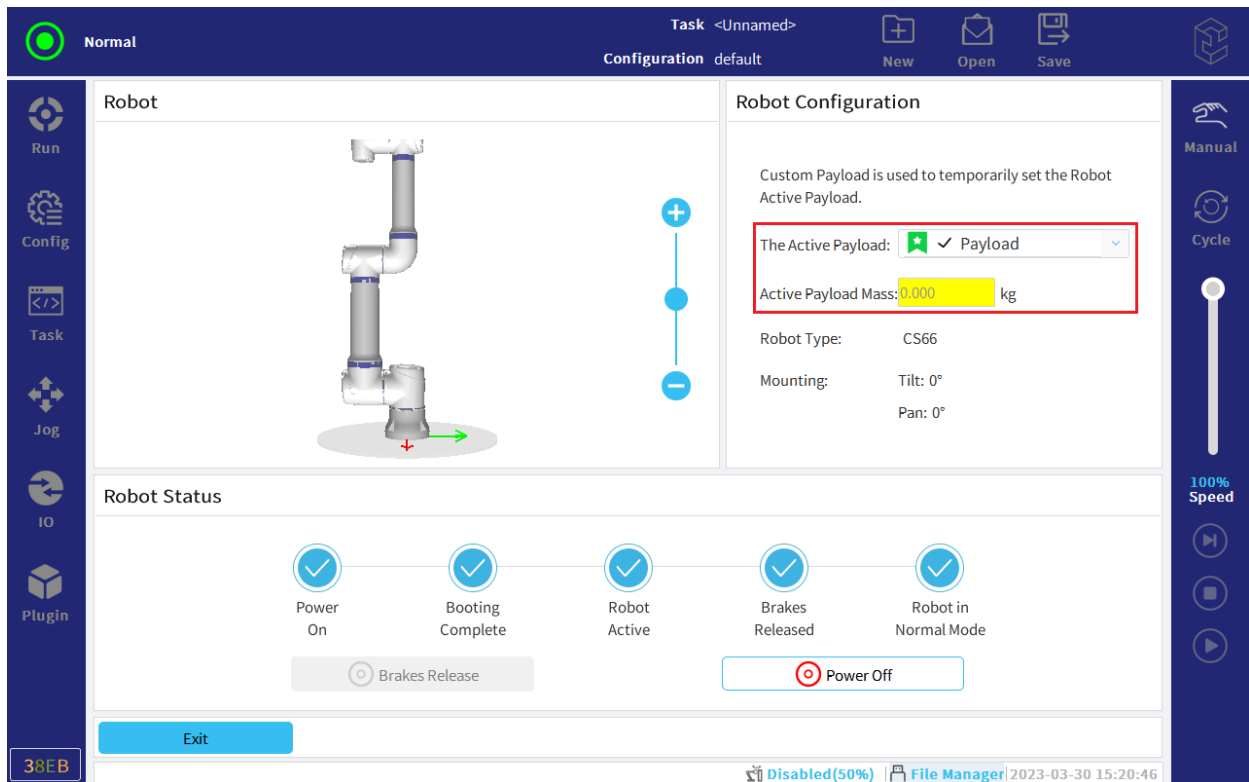

Figure 8-3 Setting payload

Note: The active payload refers to the load actually used by the robot when the task is running.

8.2 Task and Profile Management

There are tasks and configuration manager on the status and menu bar, as shown in Figure 8-4.

"Task" and "Configuration" on the left side of the manager show the name of the currently loaded task file and the name of the configuration file. If a * sign appears at the top right of the task name or configuration name, it indicates that the current task or configuration file has been modified but not saved.

The right side of the manager contains three icons: "New", "Open" and "Save".

When a new task file or configuration file is created or opened, the file name changes. When new task is created, the task uses the currently opened configuration file.

8 Status and Menu Bar

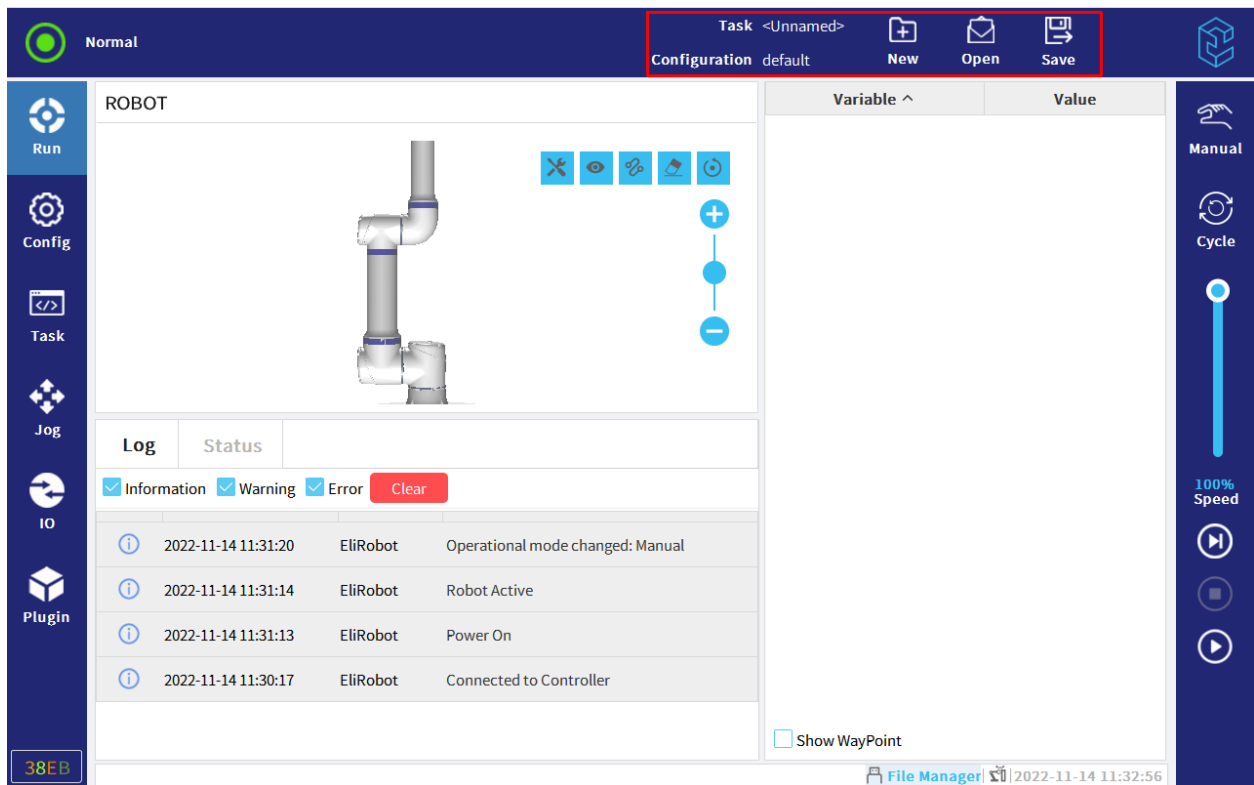

Figure 8-4 Task and configuration manager

8.2.1 New

Users can create new task files or configuration files.

The steps for creating a new task file are as follows:

1. In task and configuration manager, click "New", and then select "Task", as shown in Figure 8-5.

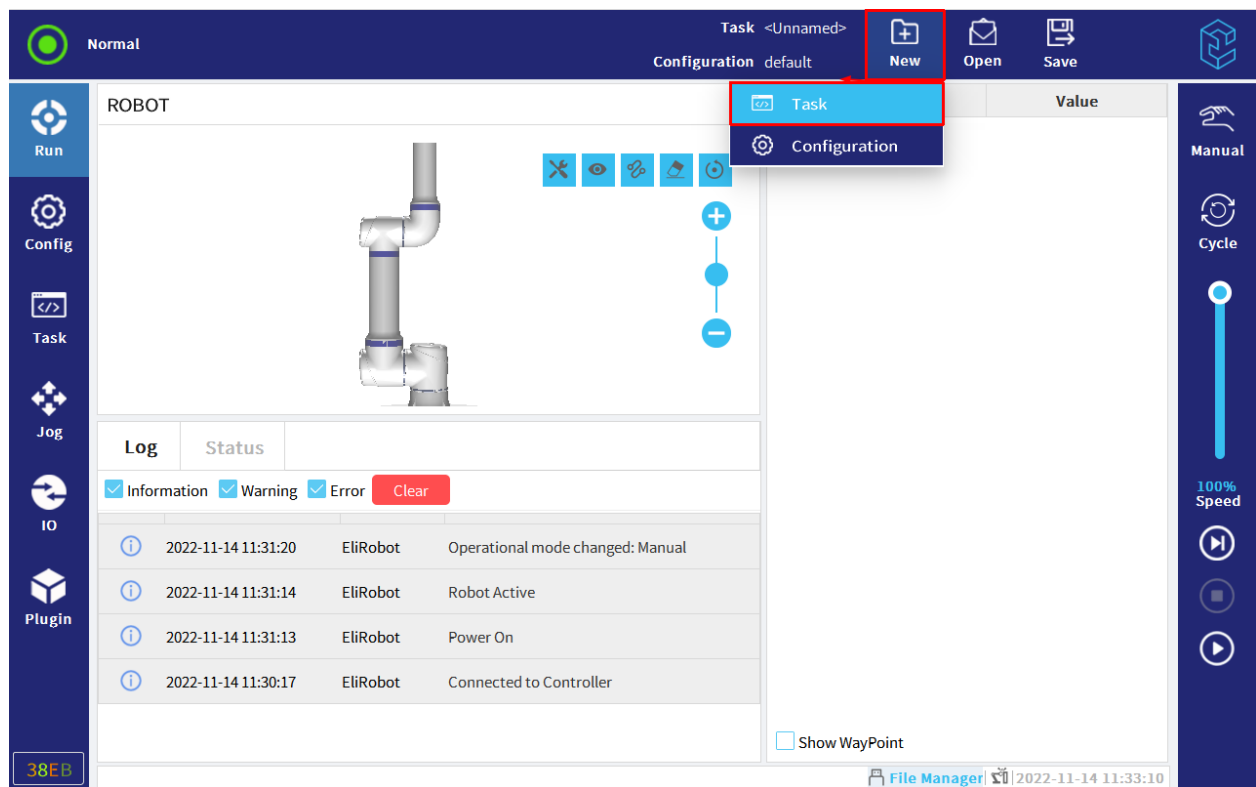

Figure 8-5 New task

2. In "Task" tab, configure new tasks as needed.
3. In task and configuration manager, click "Save".
4. Select "Save All" or "Save Task As" to save the task file.
5. In the "Task" on the left side of the manager, the name of the currently created task file will be displayed.

The steps for creating a new profile are as follows:

1. In task and configuration manager, click "New" and then select "Configuration", as shown in Figure 8-6.

8 Status and Menu Bar

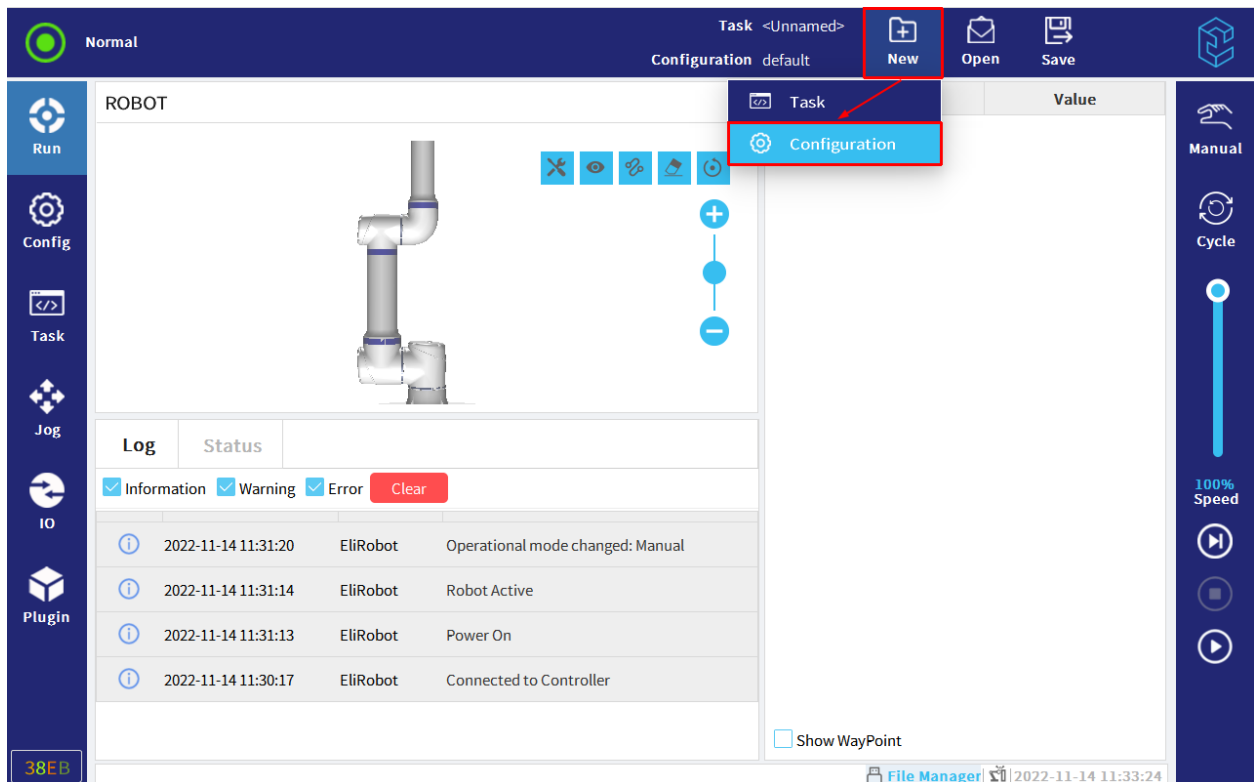

Figure 8-6 New profile

2. In "Configuration" tab, set a new configuration as needed.
3. In task and configuration manager, click "Save".
4. Select "Save All" or "Save Config As" to save the configuration file.
5. In "Configuration" on the left side of the manager, the name of the currently created configuration file will be displayed.

REMINDER



When creating a new configuration file, the new configuration file will be opened directly and a pop-up box will appear. For details, see section 8.2.2.

8.2.2 Open

The user can click "Open" to open the task file or configuration file.

Open the task file as follows:

1. In task and configuration manager, click "Open" and then select "Task", as shown in Figure 8-7.

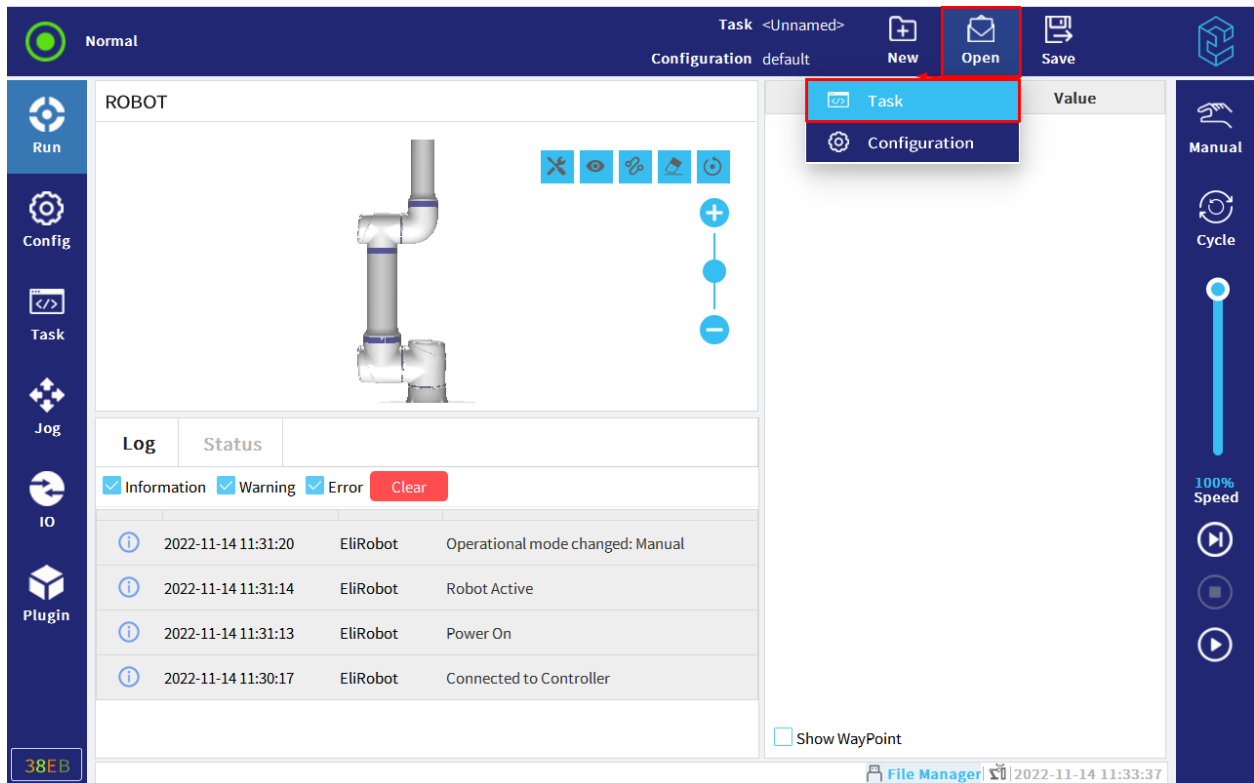

Figure 8-7 Open task

2. After selecting a task and opening it, the interface will automatically jump to the "Task" tab.

3. In the "Task" on the left side of the manager, the name of the currently opened task file will be displayed, and the configuration file used will be opened automatically.

The steps to open the configuration file are as follows:

1. In task and configuration manager, click "Open" and then select "Configuration", as shown in Figure 8-8.

- Modify only configuration file: save only configuration file;
- Modify both: save task file and configuration file.
- Save task as: after saving and renaming the currently open task file, open the saved task file;
- Save configuration as: after saving and renaming the currently open configuration file, open the saved configuration file.

8.3 Menu Shortcut

There is a menu shortcut () at the bottom of the status bar. Click the icon and a dialog will pop up, as shown in Figure 8-9.

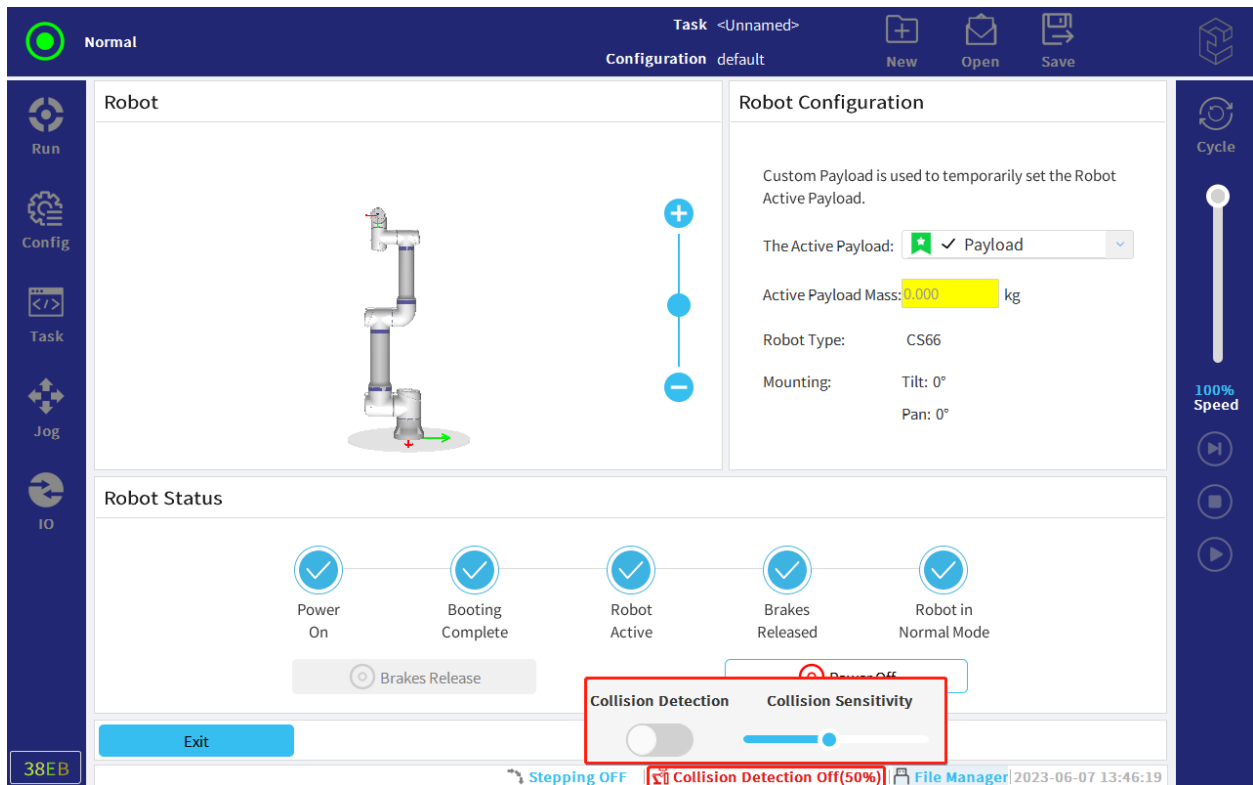











Figure 8-9 Open the menu shortcut

The collision detection can be enabled or disabled by clicking the button in the left. The user can drag the progress bar in the right to select the collision sensitivity as required. The data will not be updated in real time when dragging. Once the user releases the progress bar, the newly set collision sensitivity will display.

8.4 File Manager

The user can click the file manager at the bottom of the status bar for some operations as required. The details are presented as follows.

- Insert the USB disk into the USB ports on the teach pendant or the controller. The icon color of the USB disk at the bottom of the status bar will be changed from grey to blue. Click the blue icon to enter the file manager. An icon of the USB disk will appear in the top right-hand corner of the display. Click the icon to switch to the directory of the USB disk;
- In the directory below, click  and it will go back to the directory above;
- In the subdirectory, click  and it will enter the home page;
- Click  and a new folder will be created;
- Select the file to be copied and click , the file will be copied;
- Click  and paste the copied file. Note that please choose the directory that the user wants to paste the file first. For instance, the user expects to paste the file from the USB disk to the local. Please click the path bar to switch to the local after the copy and paste the copied file in the local directory. If the user wants to paste the file in the specified file folder, please click the specified file folder first and then paste the copied file, as shown in Figure 8-10;
- Select the file to be deleted and click , the file will be deleted;
- Select the file the user wants to rename and click , the file will be renamed;
- Select the main file folder where the user wants to create a sub file folder and click , a new sub file folder will be created;
- Click  and the current page will be refreshed.

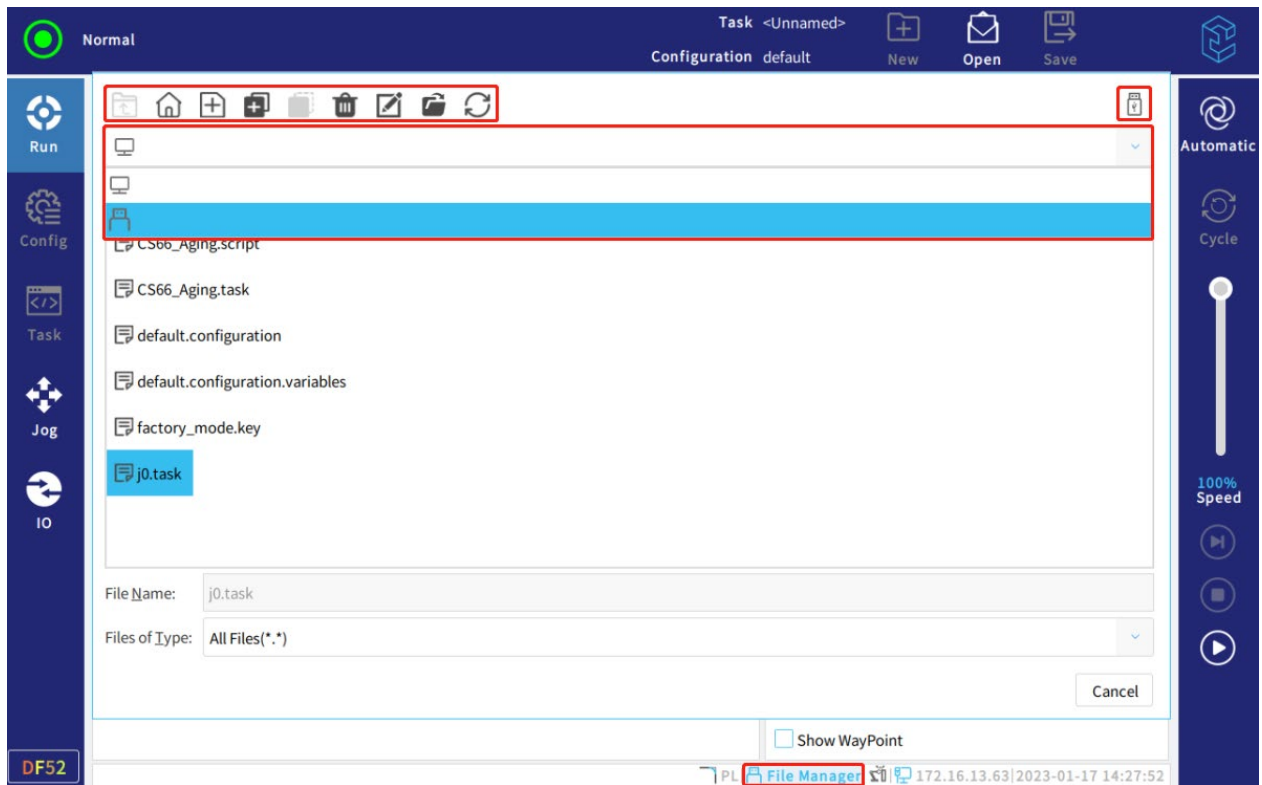



Figure 8-10 File manager

9 System Configuration

This chapter mainly describes the operation instructions of relevant configuration of the CS620 robot system, including querying relevant version/copyright information. Users can set language, time, password, etc. in the system menu, and perform system backup, recovery and update.

9.1 About

Users can query software / hardware version information, copyright information, etc.

1. Click  on the right side of the status and menu bar.
2. Click "About" to view version or legal information.
3. Click "Shut down" to return to the screen.

9.2 Setting

Click  on the right side of the status and menu bar, and click "Setting" to enter the "Setting" page.

9.2.1 Preferences

9.2.1.1 Language and Time

Users can set the language or current time and date as needed.

1. Click  on the right side of the status and menu bar.
2. Select "Settings > Preferred item > Language & Time".
3. View or adjust the language and time as needed.

4. Click "Apply and restart" to apply the changes.

Note:

- a. If it is the first time to power on the robot, a dialog box with the message "Language Setting" will pop up. The default is Chinese. Click the drop-down list in the right of the text to select other languages. Chinese, Japanese and English are now available. Click "OK" and the robot will automatically restart;
- b. If "English programming" is checked, the task bar and task tree on the right side of the "Task" tab will display English.

9.2.1.2 Run Screen

Speed slider will be enabled in automatic mode and allows for the speed of a running task to be changed.

9.2.2 Password

The user can set the operation mode password and safety password as required.

9.2.2.1 Mode

The robot can operate in manual mode or automatic mode. The user can set the mode password on the interface, as shown in Figure 9-1.

9 System Configuration

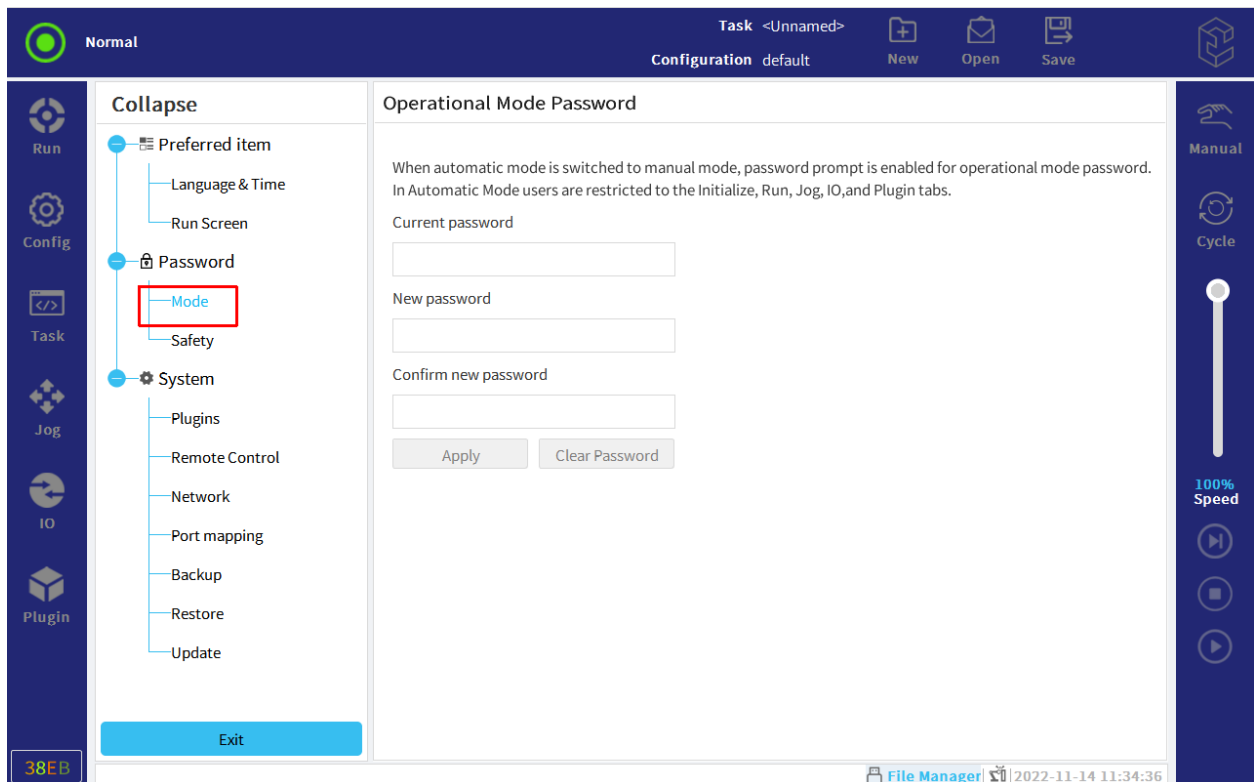

Figure 9-1 Mode password

When setting the operation mode password, the task or configuration can only be created and opened in manual mode. Whenever the user enters the manual mode, the user needs to enter the mode password set on the current page.

9.2.2.2 Safety

The safety password can prevent unauthorized changes to the safety parameter configuration.

DANGER



Before configuring the robot safety settings, the user must perform a risk assessment to ensure the safety of personnel and equipment around the robot. Risk assessment is the assessment of all work tasks during the whole life of the robot. The risk assessment is performed to apply the correct safety configuration settings. Risk assessment must be carried out and the following settings must be made:

1. The user must prevent unauthorized personnel from changing the

security configuration, such as security password protection.

2. Understand the application scenario of the robot and its corresponding safety function parameter configuration.
3. Configure the safety parameters of the teaching pendant before the robot body is powered on for the first time.
4. The user must ensure that all changes to the security configuration comply with the risk assessment.

(a) Set Safety Password

The user must set a password to unlock all safety configurations in "Config > Safety".

Note: If the safety password is not configured yet, the user will be notified to set a password.

1. Click on the right side of the status and menu bar  .

2. Select "Settings > Password > Safety" to enter the "Safety" page, as shown in Figure 9-2.

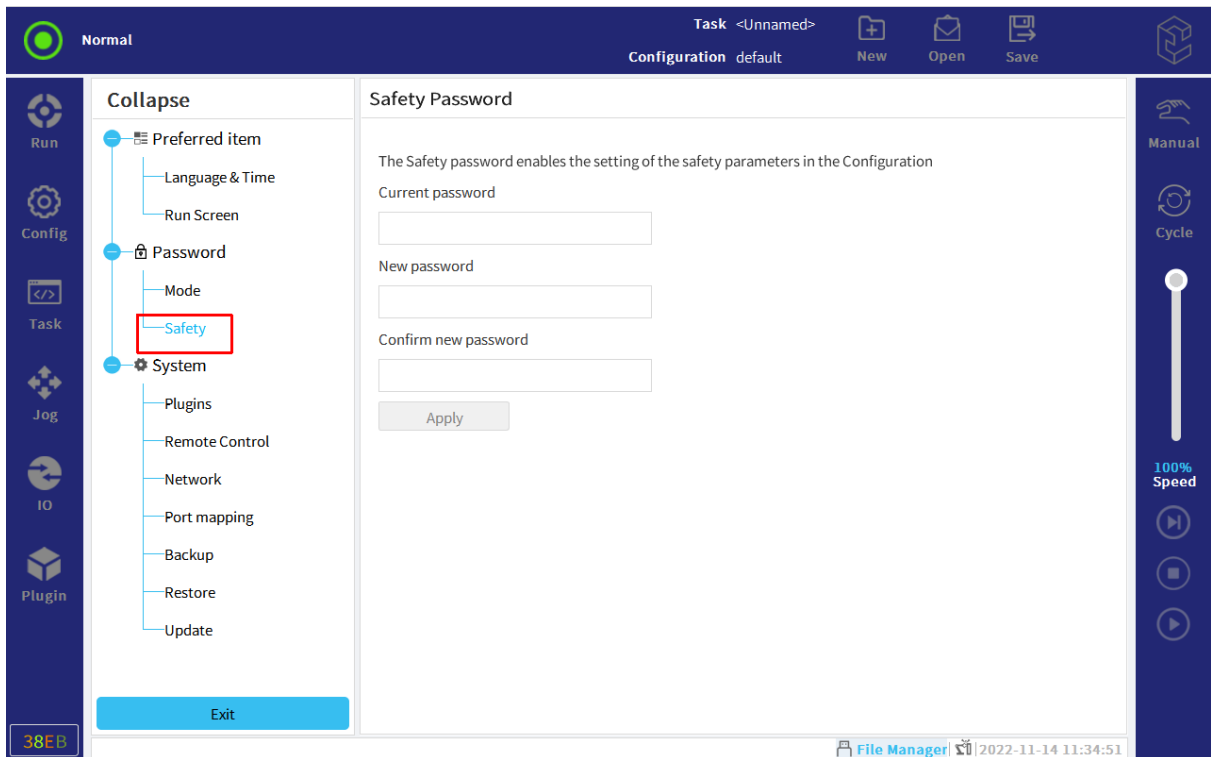

Figure 9-2 Safety password

9 System Configuration

3. Enter the current password and new password, then enter the same password as the new password in "Confirm new password".

Note: The "Current password" does not need to be entered only when the safety password is set for the first time.

4. Click "Apply" to complete the safety password configuration.

(b) Access Safety Configuration

The operation steps of accessing safety configuration are as follows:

1. In the navigation bar, click "Configuration" tab.
2. Click "Safety" to access the safety configuration.

REMINDE



The safety configuration is password protected. The safety configuration only can be changed after password is set.

After modifying the safety configuration, click "Apply" or "Lock" to save the modification.

9.2.3 System

9.2.3.1 ELITECOs

Users can click  to install plugins, as shown in Figure 9-3. Users can put the plugin on the USB flash drive, and then install the plugin on the USB flash drive by installing the plugin function.

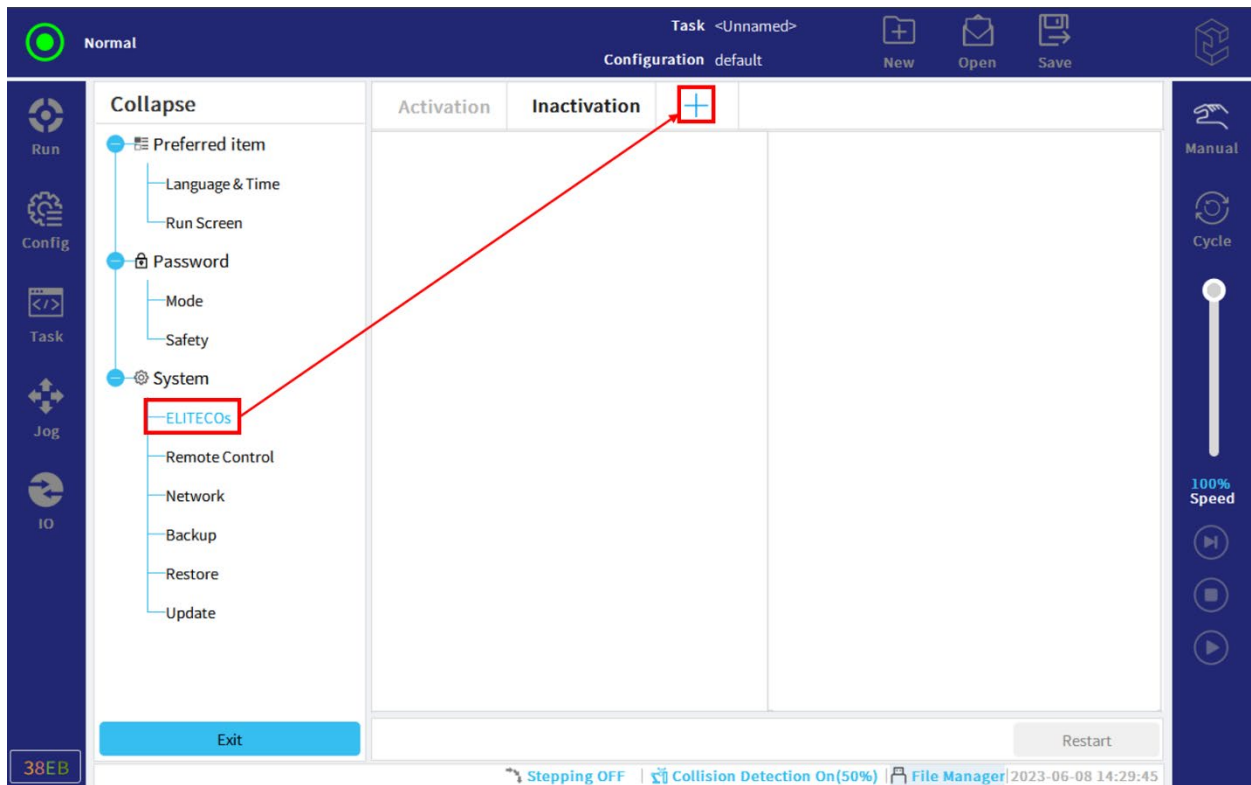

Figure 9-3 Plugins management

After the plugin is installed, click "Restart" to load the plugin; Click "Uninstall" to delete selected plugin.

Note: If the plugin is not loaded or is not successfully loaded, it can be viewed on the "Inactivation" page.

9.2.3.2 Remote Control

When disabled, click the switch button to enable the remote mode.

Remote control allows the user to control the robot via external sources, such as controller interface and IO, as shown in Figure 9-4.

9 System Configuration

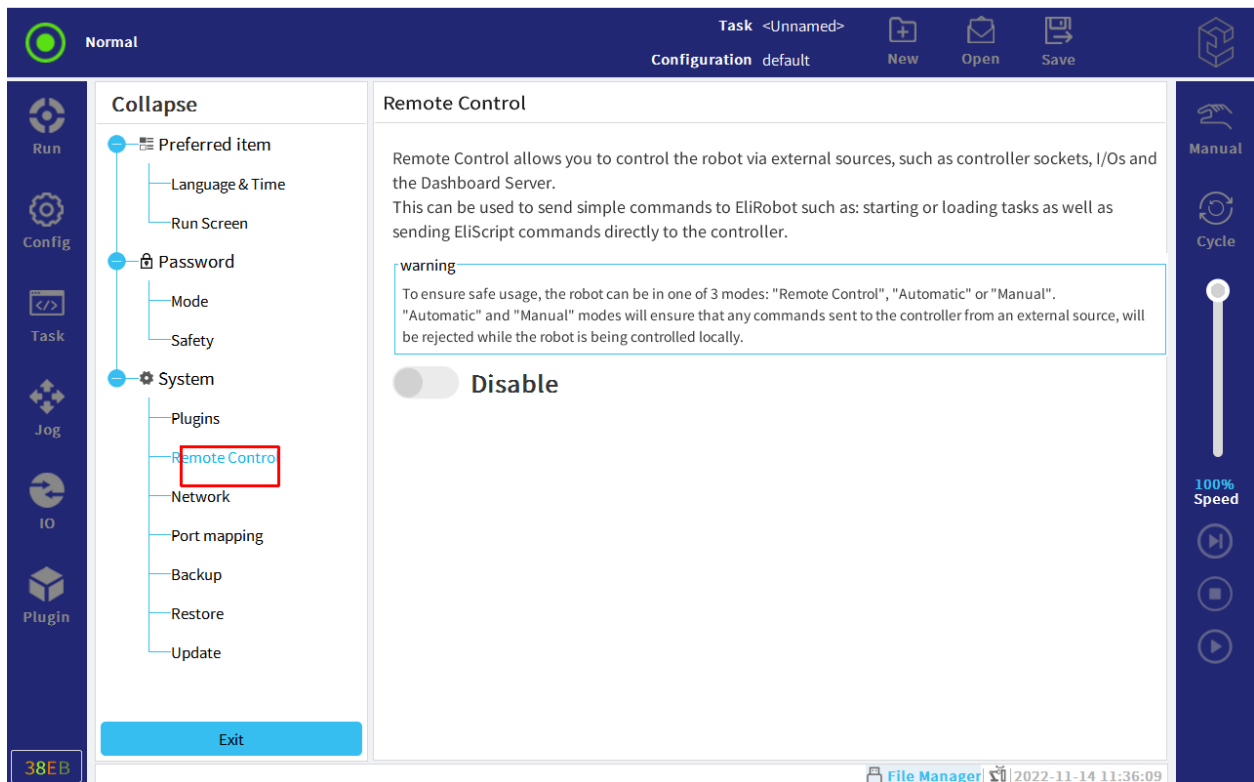

Figure 9-4 Remote control

WARNING



To ensure safety, the robot can be in "Remote Control" mode or "External" mode. In "Local" mode, any command sent to the controller from an external source will be rejected.

9.2.3.3 Network

FB1 is the network setting for communication with EliRobot, and FB2 is the network setting for communication with EliServer. Users can configure the network according to their actual needs.

The networking methods:

- DHCP;
- Static address;
- Disable network (the robot is not connected to the network).

After modifying the network configuration, click "Apply" to save the modification, as shown in Figure 9-5.

Routing Mode:

- Network port mapping is a specific routing mode provided for EliRobot to access the FB2 devices through the network.
- Configuration requirements: (when the routing mode is enabled)
 - FB1 network cannot be in the same network segment as FB2 network.
 - The external device network settings should be in the same network segment as FB2.
 - The default gateway of the external device must be the IP address of FB2.
- Note: It is valid only for EliRobot to access the external devices.

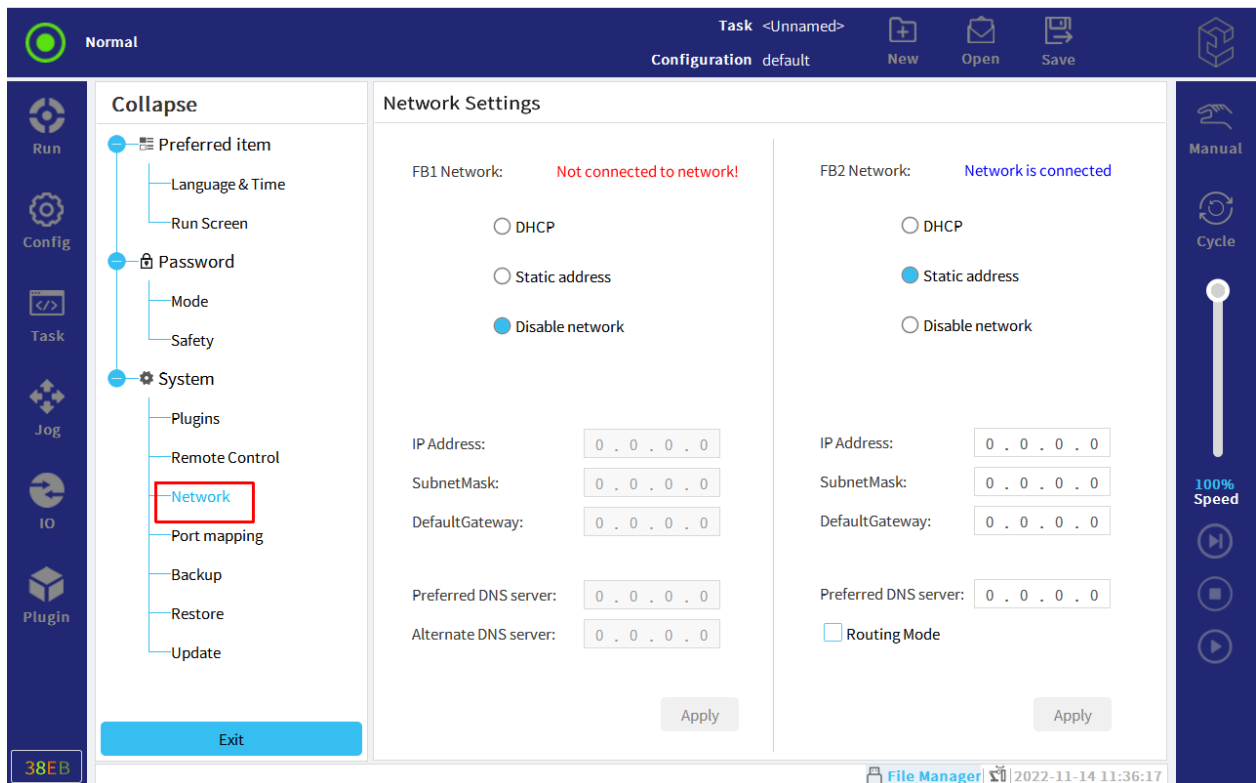



Figure 9-5 Network

9.2.3.4 Backup

Users can back up tasks and configuration files to USB flash disk to counter accidents such like unintentional files removal.

9 System Configuration

1. Click  on the right side of the status and menu bar.
2. Select "Settings > System > Backup", as shown in Figure 9-6.

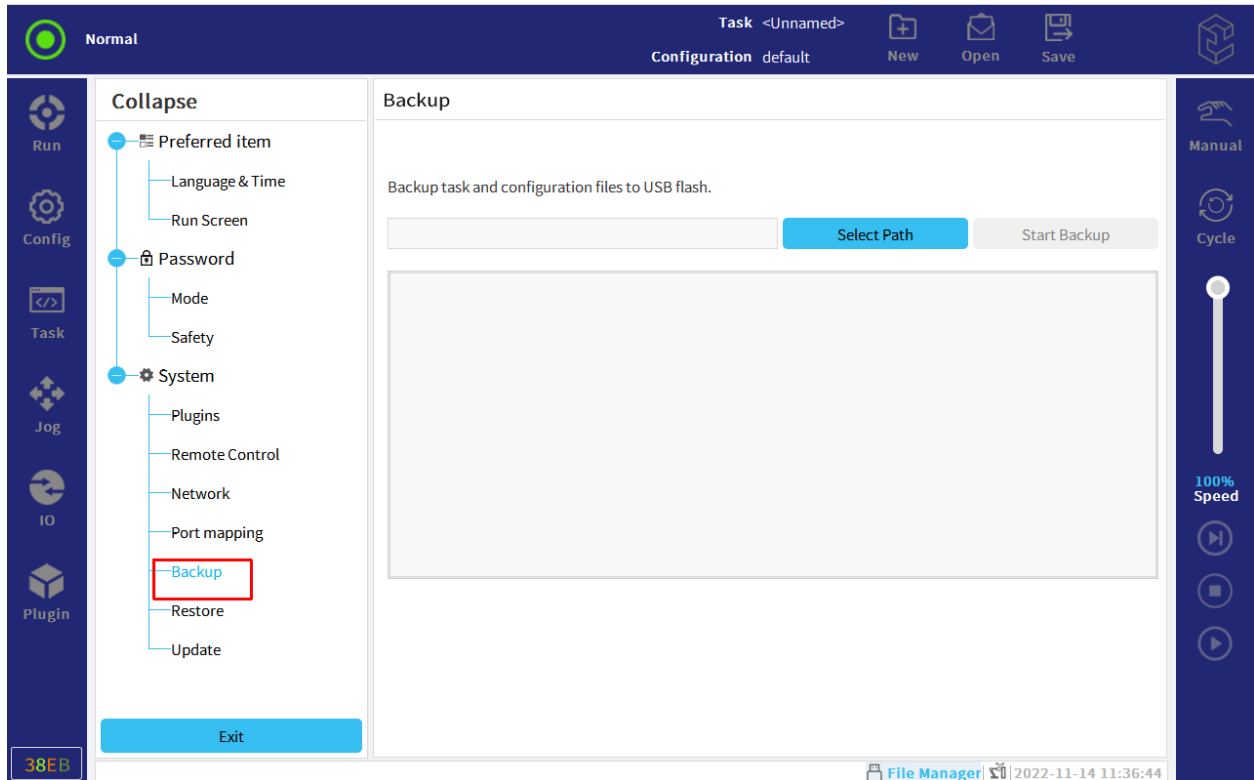



Figure 9-6 Backup

3. Click "Select Path" and select the location where the file is stored for backup.
4. Click "Start Backup".

9.2.3.5 Restore

The user can restore the tasks and configuration files under the USB flash disk to the system.

1. Click  on the right side of the status and menu bar.
2. Select "Settings > System > Restore", as shown in Figure 9-7.

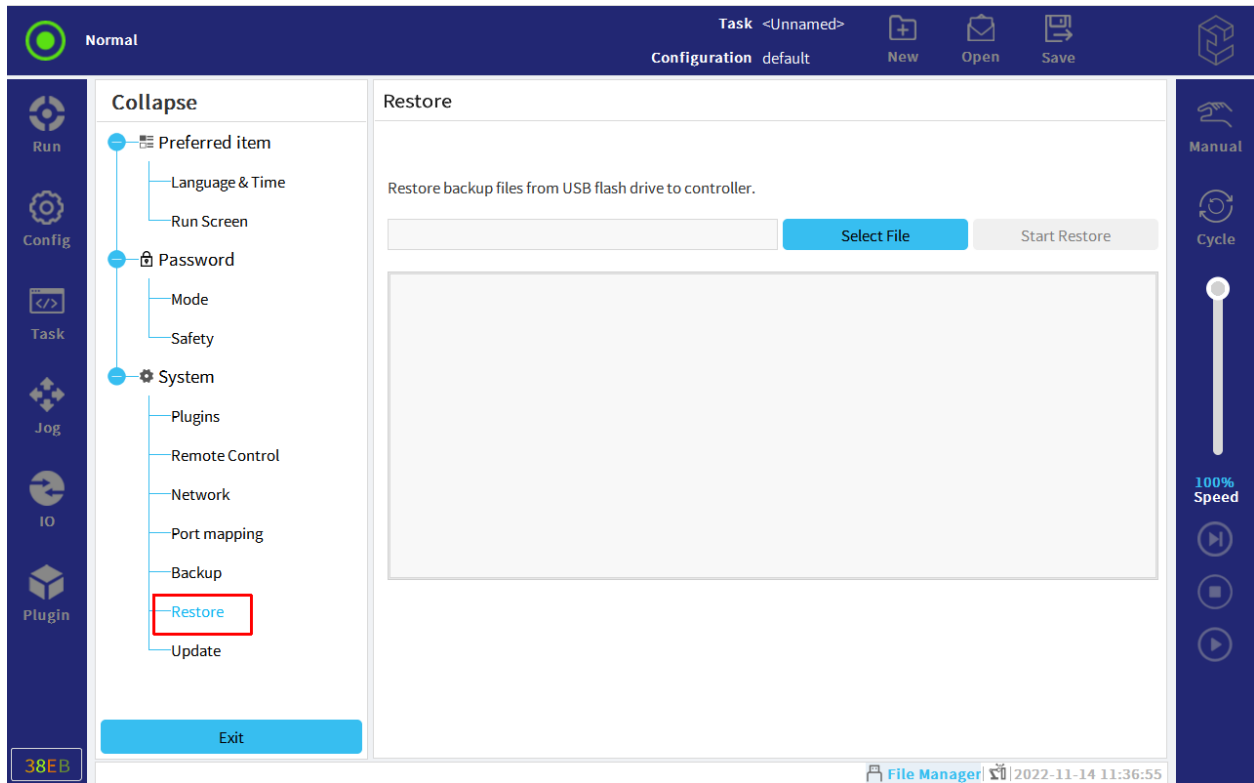



Figure 9-7 Restore

3. Click "Select file" and select the task and configuration file to be imported.
4. Click "Start Restore".
5. On the pop up window, press "OK" to confirm.

9.2.3.6 Update

Users can update applications, drivers or systems.

1. Click  on the right side of the status and menu bar.
2. Select "Settings > System > Update", as shown in Figure 9-8.
3. Put the upgrade package into the USB flash disk and insert it into the USB flash disk.
4. Updated content:

System Update: click "Update" and "OK" under the system, as shown in Figure 9-9. Click the "start" button in the interface, and then select upgrade package with the suffix. eru to

9 System Configuration

upgrade the system. After the upgrade is successful, the system will restart automatically to complete the system update;

Application Update: click "Search" to search for a one-stop upgrade package with the suffix. eup, as shown in Figure 9-10. Click "Update" to select the upgraded modules as required, or click to select all modules, as shown in Figure 9-11 and Figure 9-12, and then click "OK" to update, as shown in Figure 9-13.

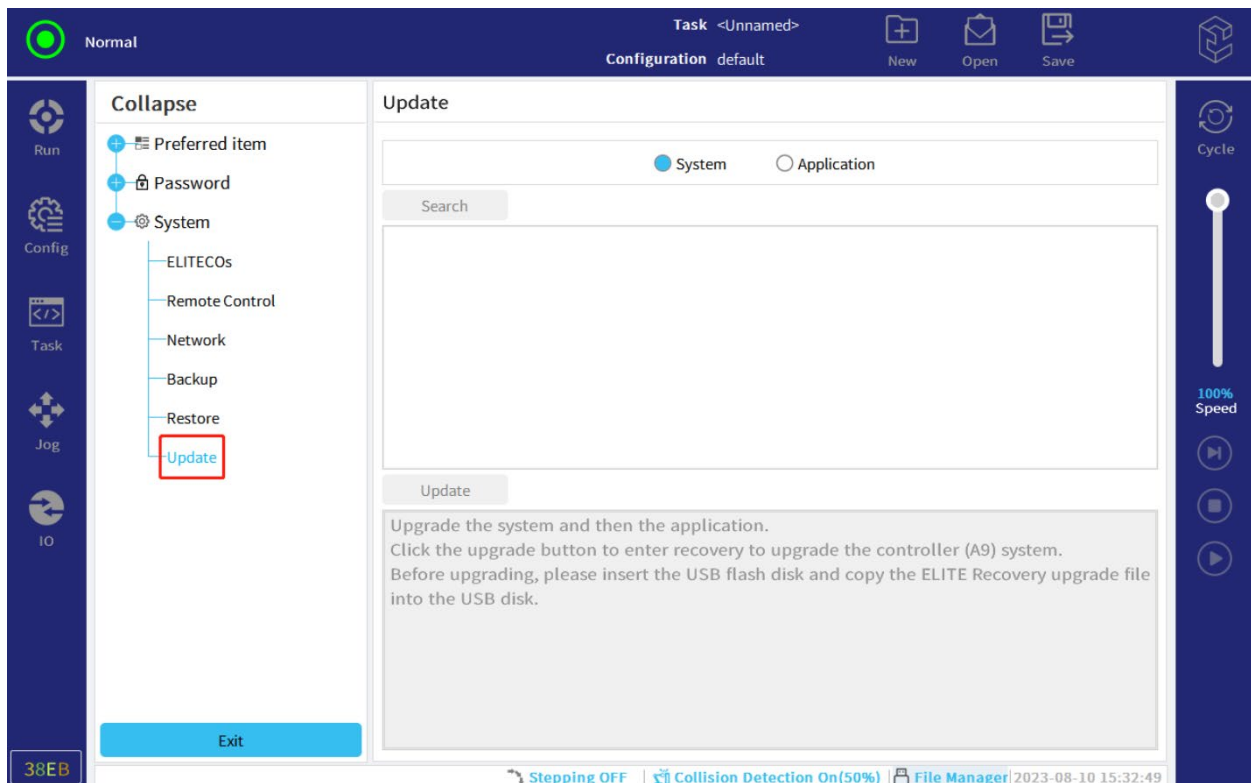

Figure 9-8 Update

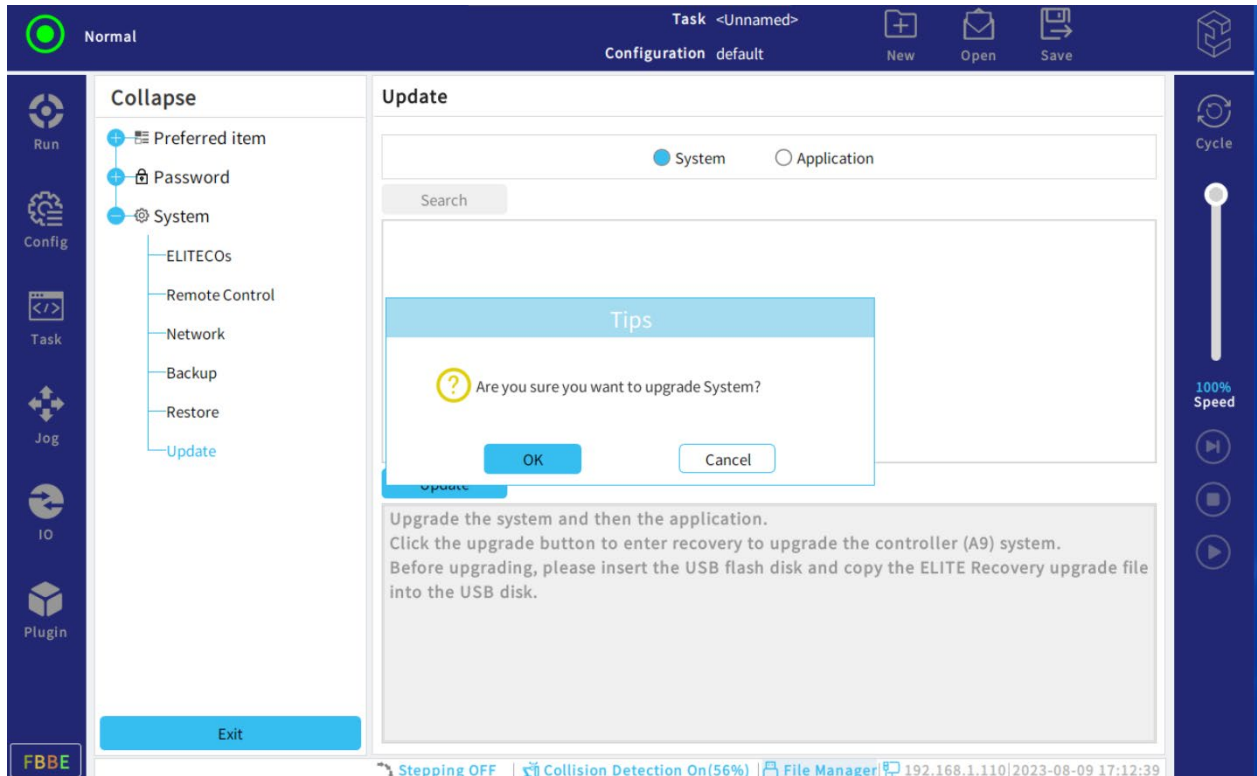

Figure 9-9 System update

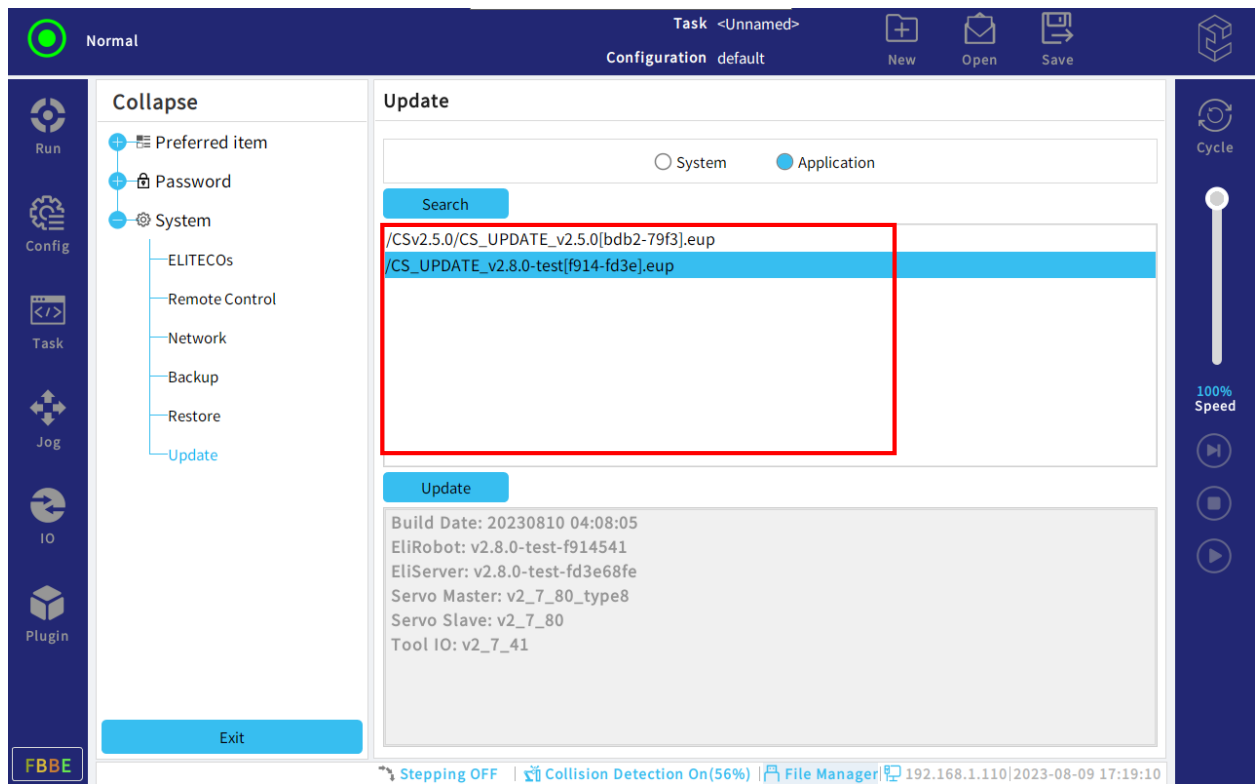

Figure 9-10 Application update

9 System Configuration

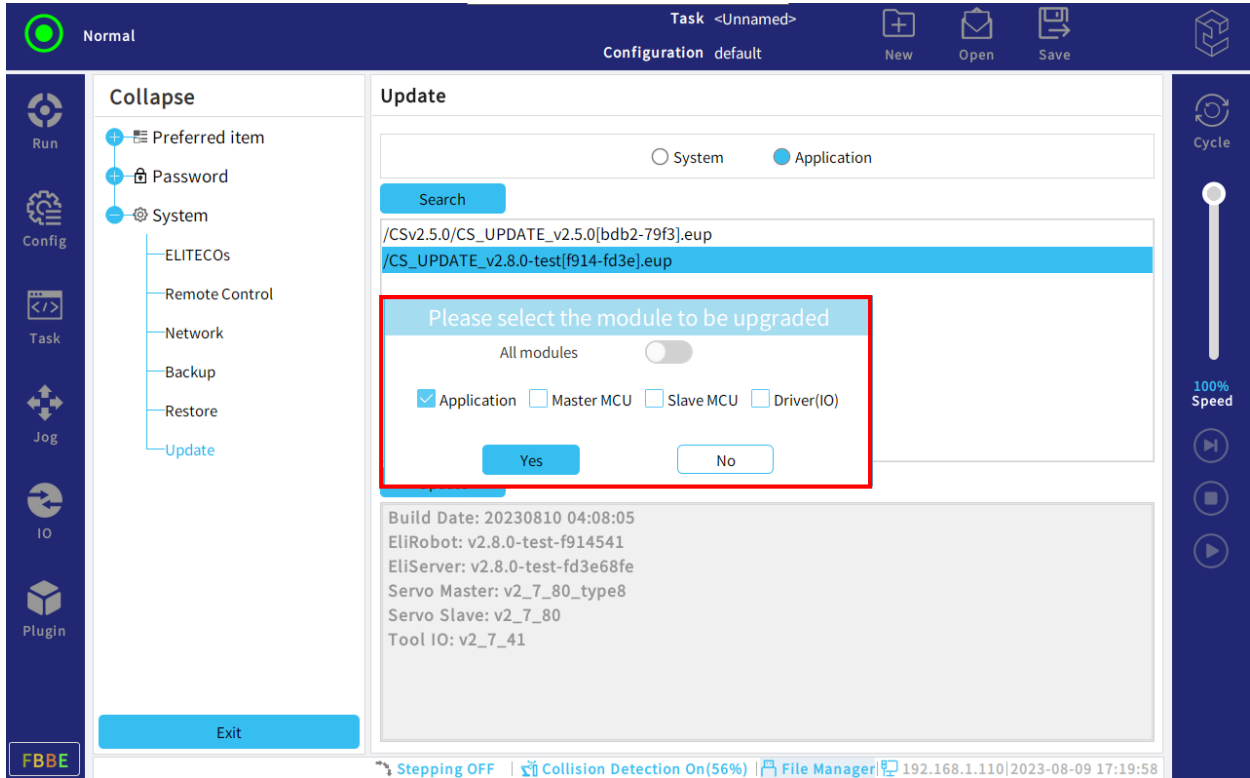

Figure 9-11 Select module

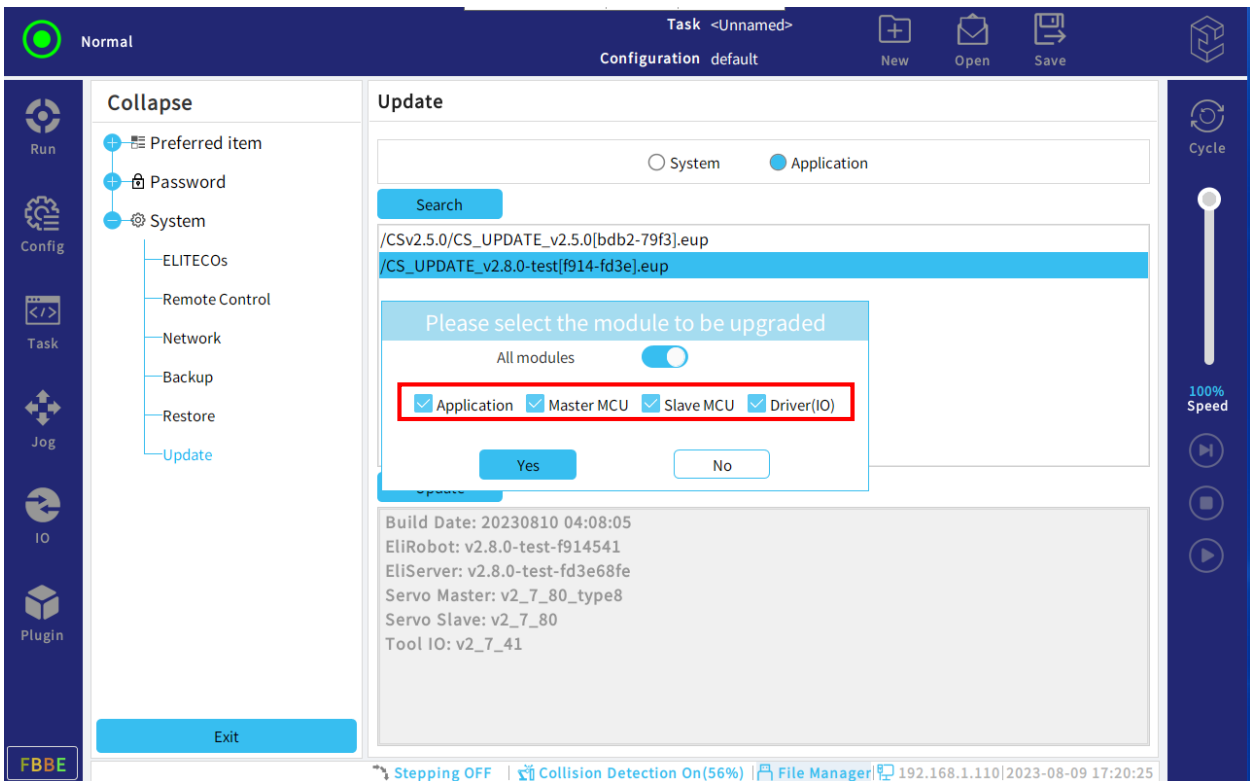

Figure 9-12 Select all modules

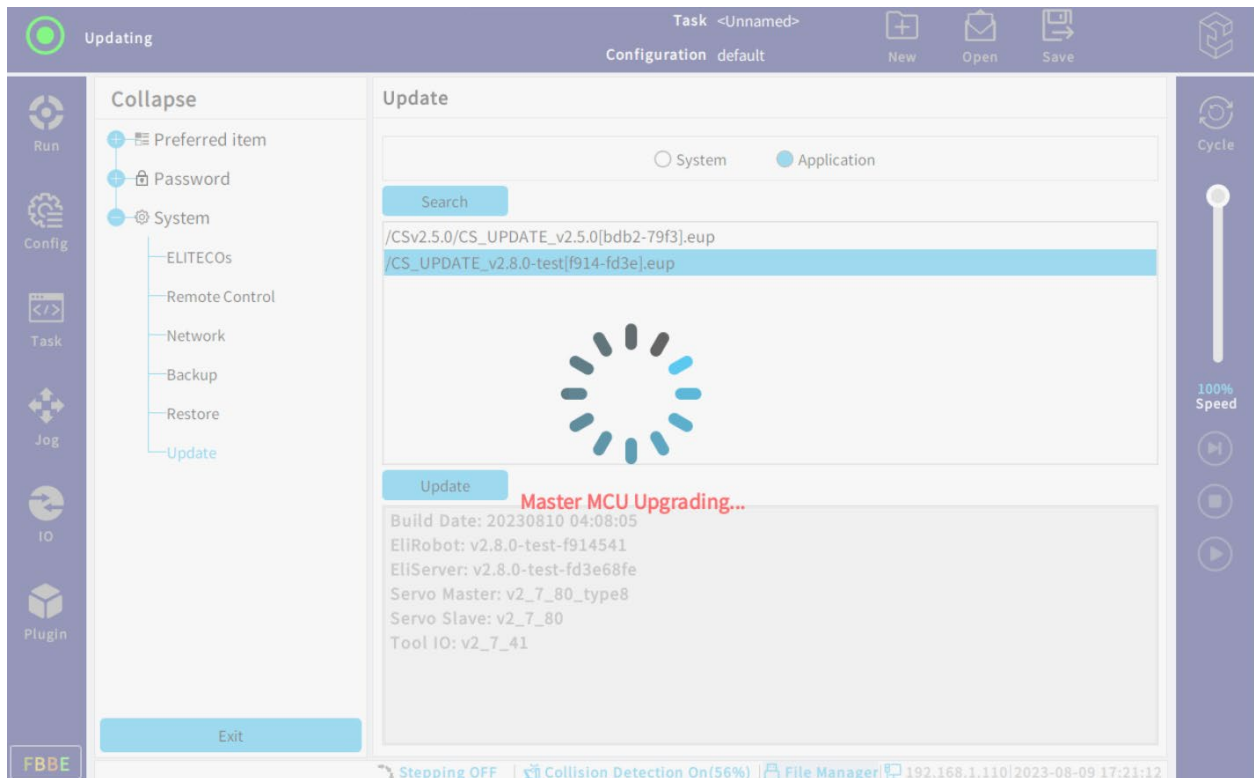



Figure 9-13 Application updating

9.3 Shut down

Turn off the robot button to power off or restart the robot. The operation steps are as follows:

1. Click  on the right side of the status and menu bar.
2. Select "Settings > System > Shut down".
3. Click "Shut down" or "Restart" to shut down or restart the robot.

10 Run Tab

This chapter mainly describes the options in the operation of the CS620 robot, including log, robot status and variable.

Users can query logs and robot status and monitor variables, as shown in Figure 10-1.

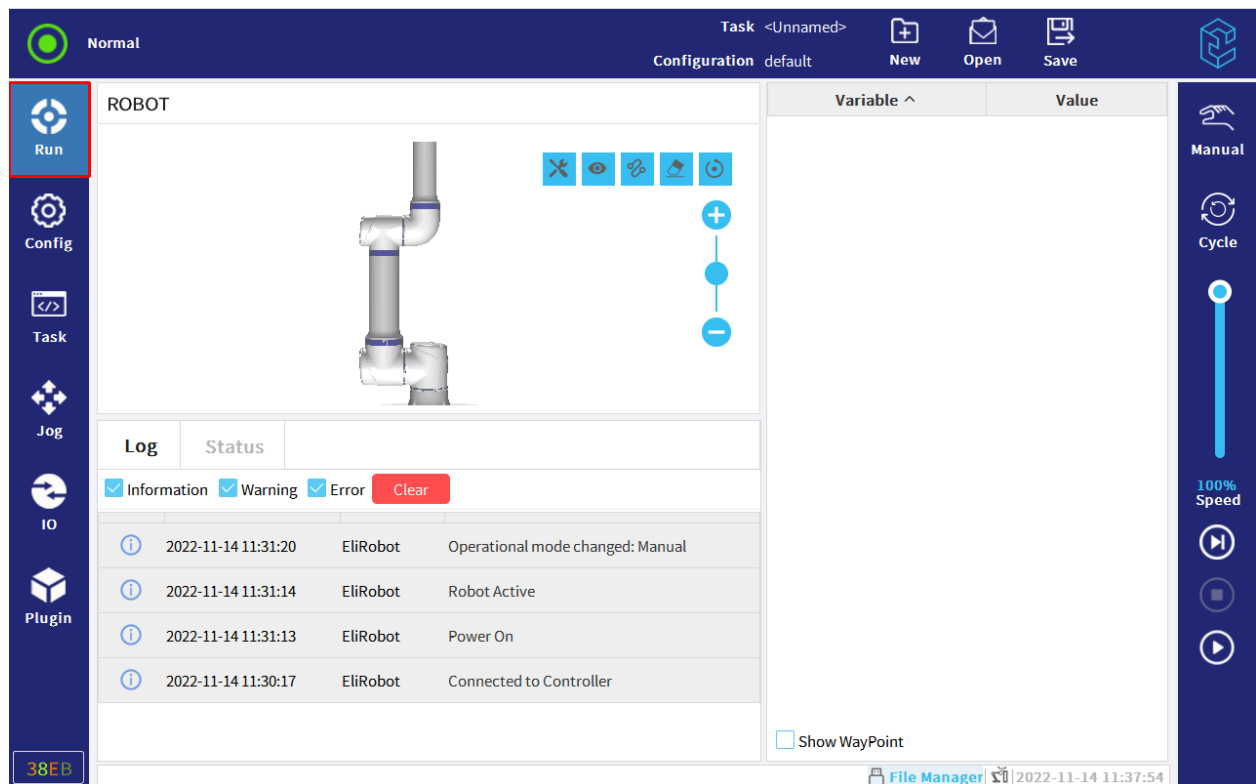

Figure 10-1 Run

10.1 Log

The log records the prompts, warnings and error messages generated during the operation of the robot.

Users can sift logs by checking or unchecking the check box.

The first column of the log is classified according to the severity of the log record. The second column shows the arrival time of the message. The last column shows the specific information of the log. Click "Clear" to clear the current log list.

10.2 Status

The user can view the robot status in the status interface, including running time, joint temperature, joint current and other parameters, as shown in Figure 10-2.

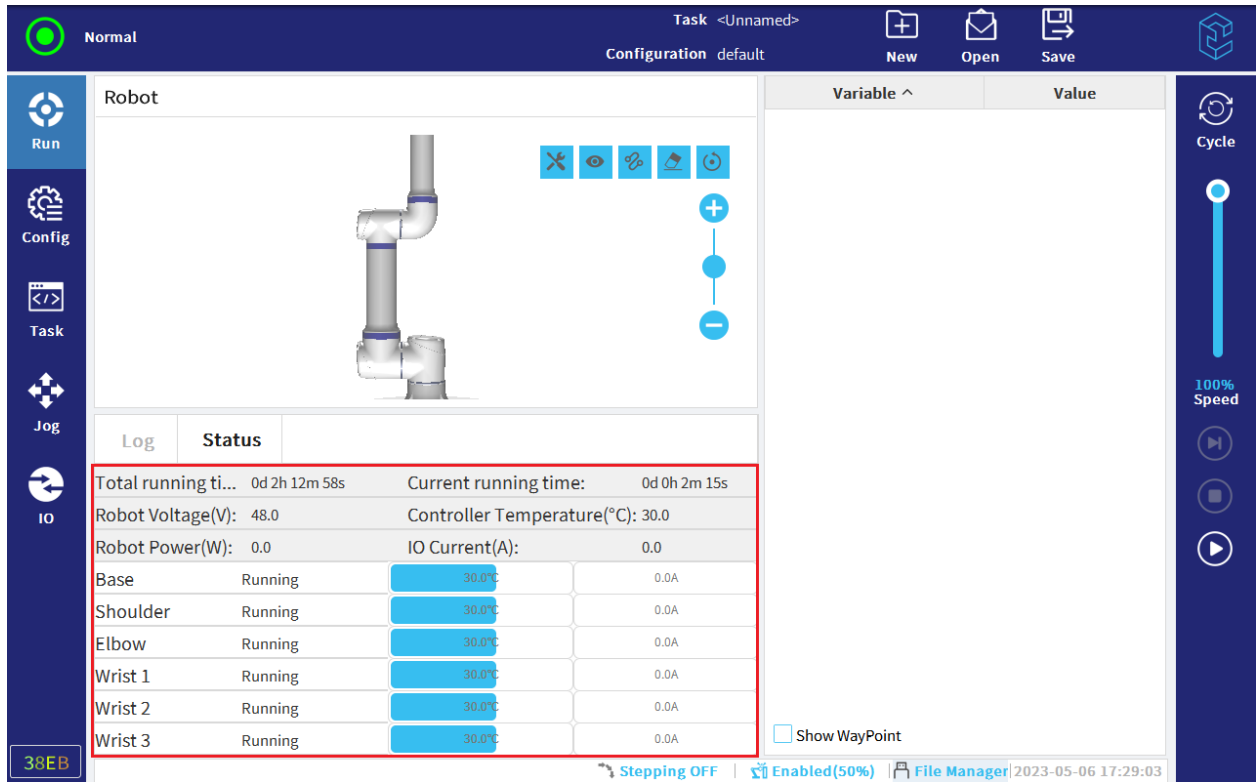

Figure 10-2 Status

10.3 Variable

The user can monitor variables on the current page, as shown in Figure 10-3, see section 12.3 for details.

10 Run Tab

Normal Task <Unnamed> Configuration default New Open Save

ROBOT

Log Status

Run time:	0 Days 23 Hours 11 Minutes 9 Seconds
Joint temperature(°C):	30.0,30.0,30.0,30.0,30.0,30.0
Joint Current(A):	0.0,0.0,0.0,0.0,0.0,0.0
Robot Voltage(V):	48.0
Controller Temperature(°C):	30.0
Robot Power(W):	0.0
IO Current(A):	0.0

Variable ^	Value

100% Speed

38EB File Manager 2022-11-14 11:38:55

Figure 10-3 Variable

11 Configuration Tab

This chapter mainly describes the options and operation instructions in the configuration of the CS620 robot, including general, safety, communication, plugin and other options. Users can carry out robot arm mounting, TCP, payload, frame, force control and other operations in general. The configuration of security parameters includes robot limit, joint limit, safety planes, safety I/O and three position. Users can use Modbus client IO signal and plugin configuration.

11.1 General

11.1.1 Mounting

The mounting of the specified robot arm has two purposes:

1. Correctly display the manipulator on the screen.
2. Inform the controller of the gravity direction.

WARNING

If the mounting posture of the robot arm is not set correctly, it will lead to unexpected movement when the robot arm is in free dragging mode.

If the robot arm is mounted on a smooth surface or floor, no changes need to be made to this screen. However, if the robot arm is mounted on a ceiling, wall, or at a certain Angle, the mounting posture must be correctly set, as shown in Figure 11-1.

11 Configuration Tab

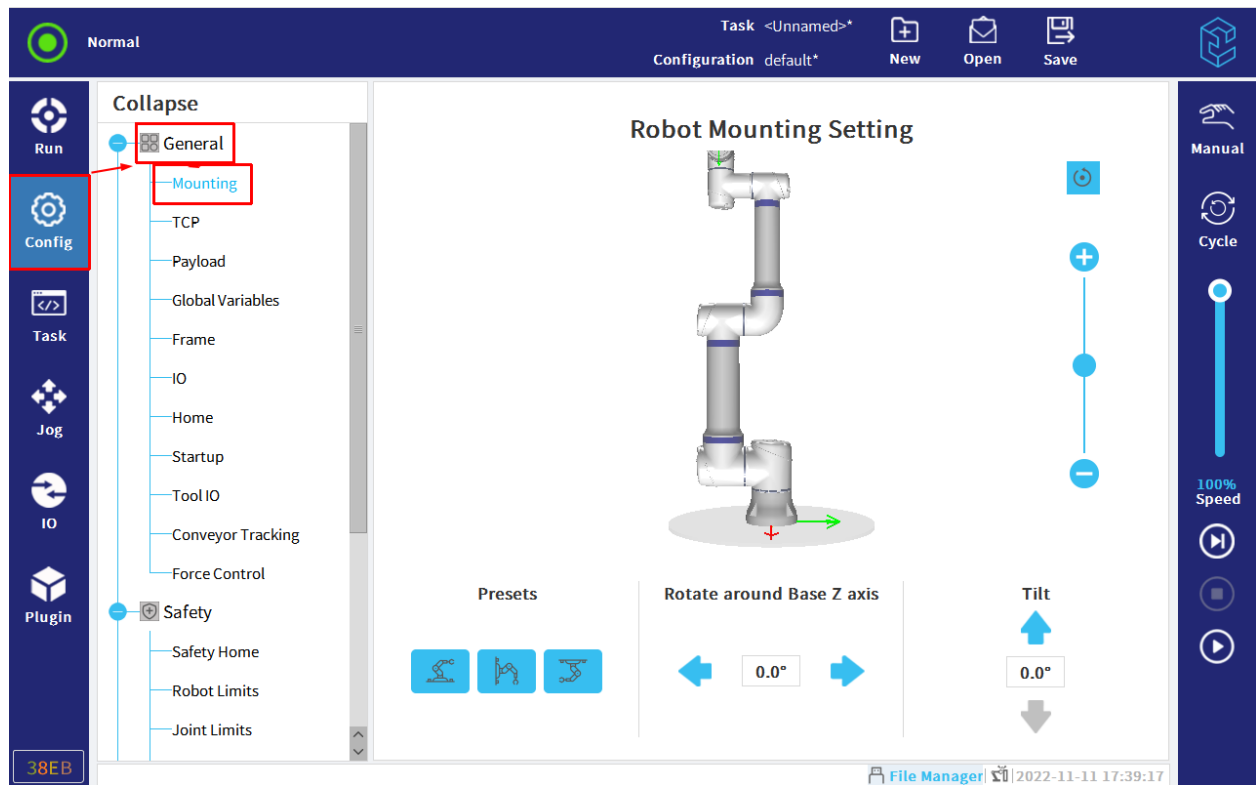

Figure 11-1 Mounting

The three "Presets" buttons represent three mounting methods: floor, wall, ceiling mounting. "Rotate around Base Z axis" is used to rotate the mounting angle of the robot arm, which should be consistent with the actual mounting angle as far as possible. The "Tilt" button sets the plane angle.

11.1.2 TCP

In order to ensure that the robot can correctly perform the operations of moveL, moveJ, moveP and other motion types, the accurate size information of the tool must be recorded, and the position of the tool center point (TCP) must be defined.

After modifying the TCP, the robot will move to the Cartesian attitude saved in the waypoint with the new TCP.





11.1.2.1 Position

The X, Y, and Z coordinates specify the TCP location. When all values (including direction) are zero, TCP coincides with the center point of the tool output flange.

11.1.2.2 Pose

The RX, RY, and RZ frames specify the TCP direction. Pose Format can be chosen between degrees or radians from the drop-down menu.

11.1.2.3 Other

- Copy: click , copy a TCP;
- Add: click  to create a new TCP;
- Rename: select the TCP to rename and click  ;
- Delete: select the TCP to delete and click  ;
- Note: The last TCP cannot be deleted.
-  : is the currently activated TCP.

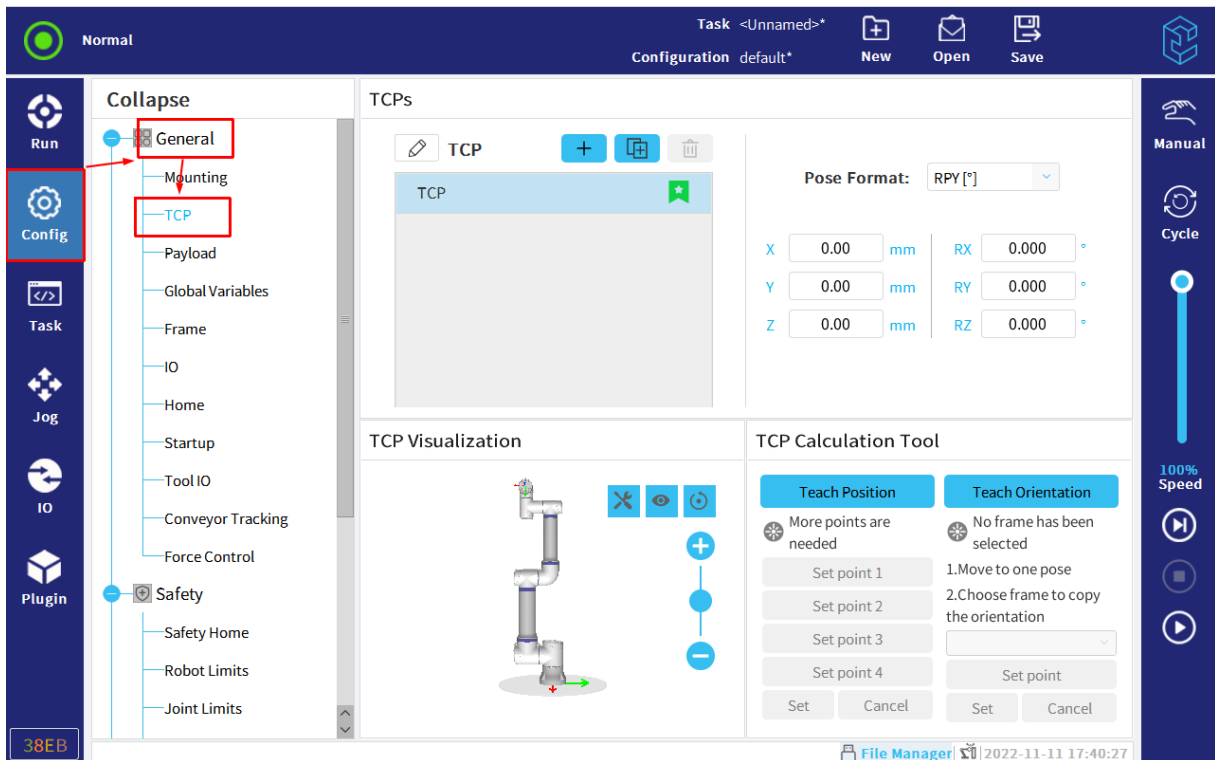

Figure 11-2 Other functions

11 Configuration Tab

11.1.2.4 Teach Position

TCP position coordinates can be calculated automatically through the following steps:

1. Click "Teach Position > Set point 1", as shown in Figure 11-3.

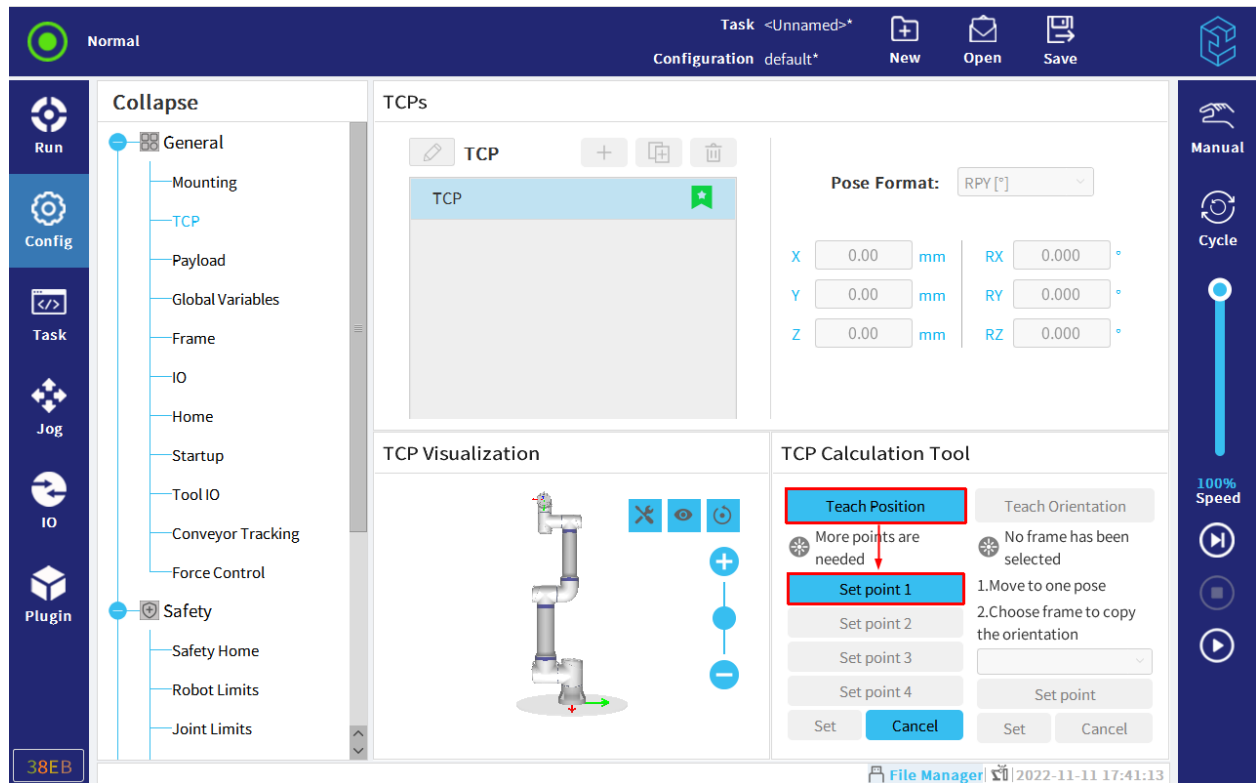

Figure 11-3 Set point 1

2. Set a fixed point in the robot workspace. Use the position arrow on the right side of the screen to move TCP from at least three different angles.
3. Click "Set" in the lower left corner of the page.
4. Click "Set point 2", "Set point 3" and "Set point 4" to set the point.
5. Click "Set" to apply the verified coordinates to the appropriate TCP.

The attitude of the four points from point 1 to point 4 should be as different as possible to ensure the correct calculation results. If the difference between them is small, the status LED above the button will turn red.

Even though three locations are usually enough to determine TCP, the fourth location is still needed to further verify that the calculation result is correct.

11.1.2.5 Teach Pose

TCP direction can be calculated automatically through the following steps:

1. Click "Teach Pose", as shown in Figure 11-4.

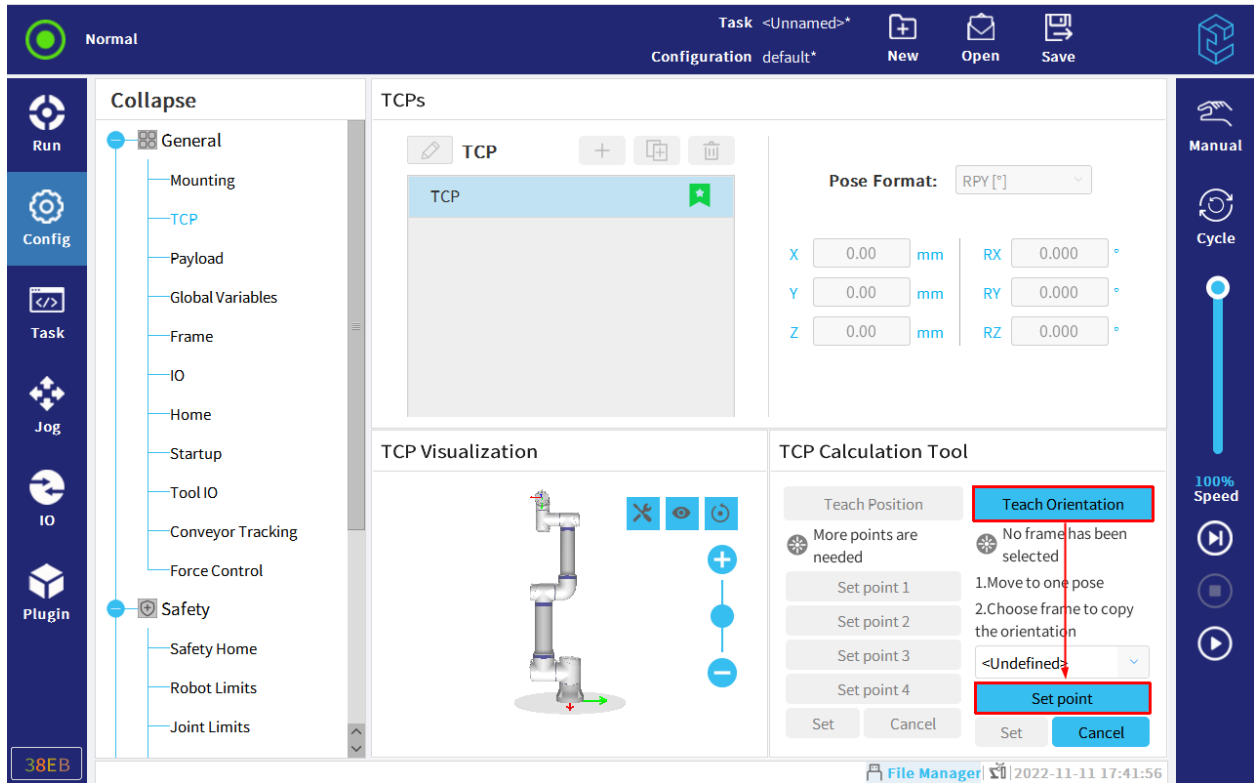

Figure 11-4 Teach Pose

2. Select a frame from the drop-down list.
3. Click "Set point" to ensure that the direction of the tool and the corresponding TCP coincide with the selected frame.
4. Verify the calculated TCP direction, click "Set" and reference it to the selected TCP.

11.1.3 Payload

The user can specify the weight of the payload and define the center of gravity, and can add, rename, delete, copy and other operations on the payload, as shown in Figure 11-5.





11 Configuration Tab

11.1.3.1 Add Payload

The operation steps are as follows:

1. Click  to create a new payload.
2. Set the "Mass" and "Center of Gravity(CoG)" of the payload.
3. To customize the inertia matrix, check "Custom" and enter the calculated inertia value.

11.1.3.2 Other Operations

- Copy: click , copy a payload;
 - Rename: select the payload to rename and click  ;
 - Delete: select the payload to delete and click  ;
- Note: The last payload cannot be deleted.
-  : the payload that takes effect in the task when the task is running;
 - Immediate setting: click "Set Now", a black check mark will appear, indicating that the payload is activated immediately, as shown in Figure 11-5.

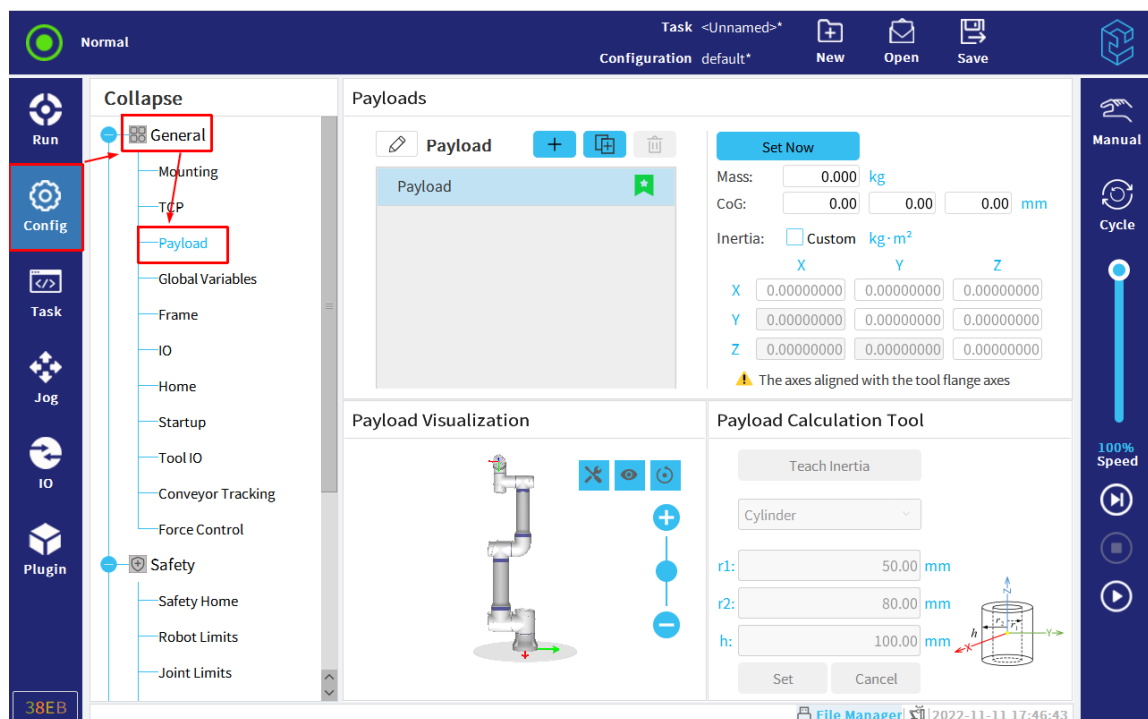

Figure 11-5 Set payload now

11.1.4 Global Variable

Users can create global variables in “Config > General > Global Variables”, which can be used in tasks.

TIPS



The global variable is used in the task, and the value of the variable changes when the task runs, and the value in the “Config” will also be updated.

The value of the global variable will be saved to the system in real time. In other words, even if the task stops running, or the robot arm and controller are powered off and restarted, the data of global variables will remain unchanged.

The user can perform the following operations on the interface, as shown in Figure 11-6.

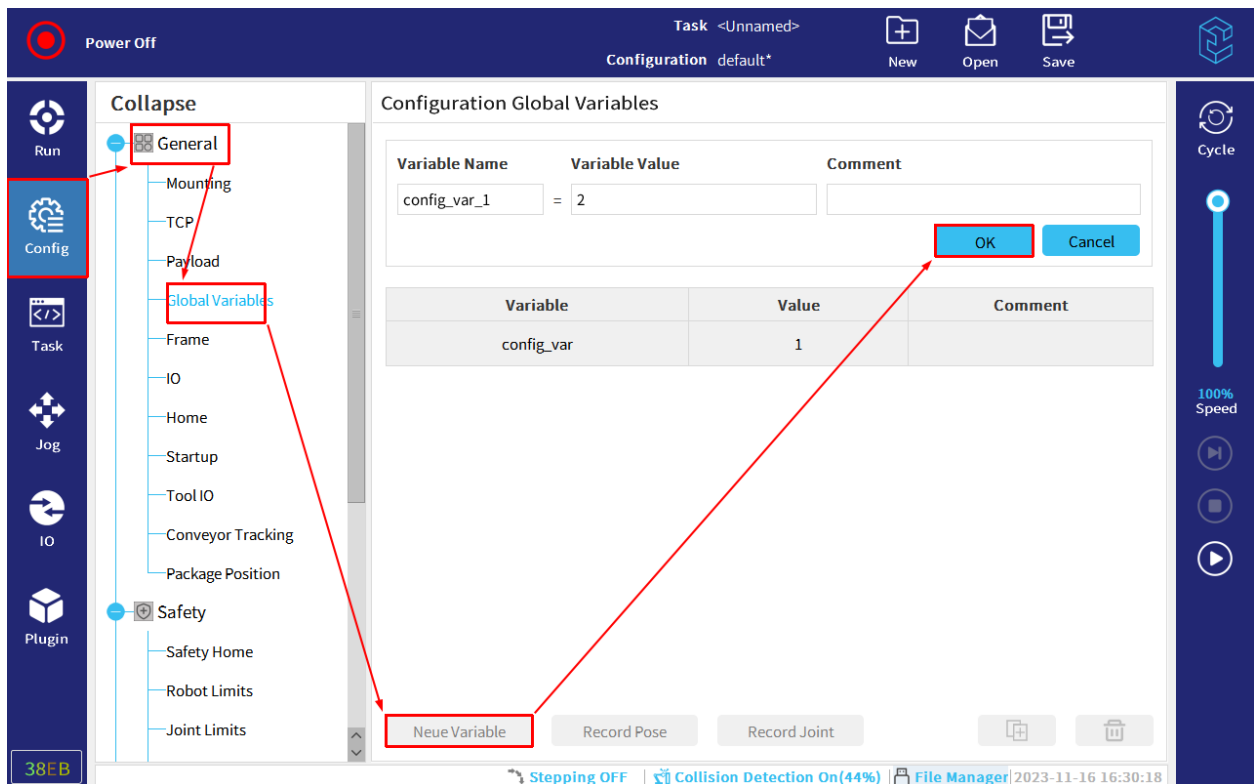

Figure 11-6 Global variables

New variable: click "Neue Variable" and set the variable name and value. The variable type supports int, float, boolean, string and vector with length of 6. After setting, click "OK" to complete the variable creation.

11 Configuration Tab

Record pose: click "Record Pose" to record the data for current pose (rounded to 5 decimal places).

Record joint: click "Record Joint" to record the data for current joint (rounded to 5 decimal places).

Modify variable value: click the variable to be modified and the button "OK" becomes "Edit". Then modify it in the related textbox and click "OK" to complete variable modification.

Delete variable: select the variable to be deleted and click  .

Copy variable: select the variable to be copied and click  .

11.1.5 Frame

The user can input the frame value manually, or operate the robot to teach three points to configure the frame.

11.1.5.1 Add Frame

The operation steps of adding frame are as follows:

1. Click "Config > General > Frame", click  , as show in Figure 11-7.

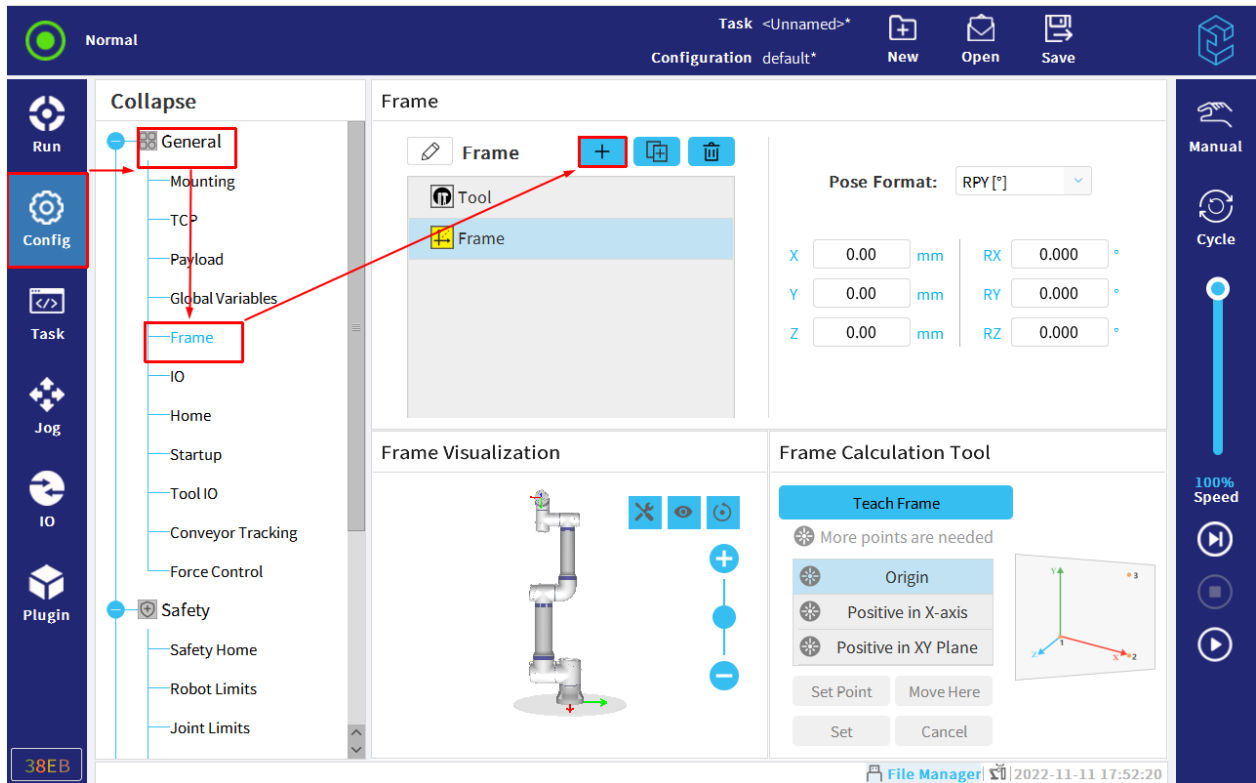

Figure 11-7 Add frame

2. Click "Teach Frame > Origin > Set Point", as shown in Figure 11-8.

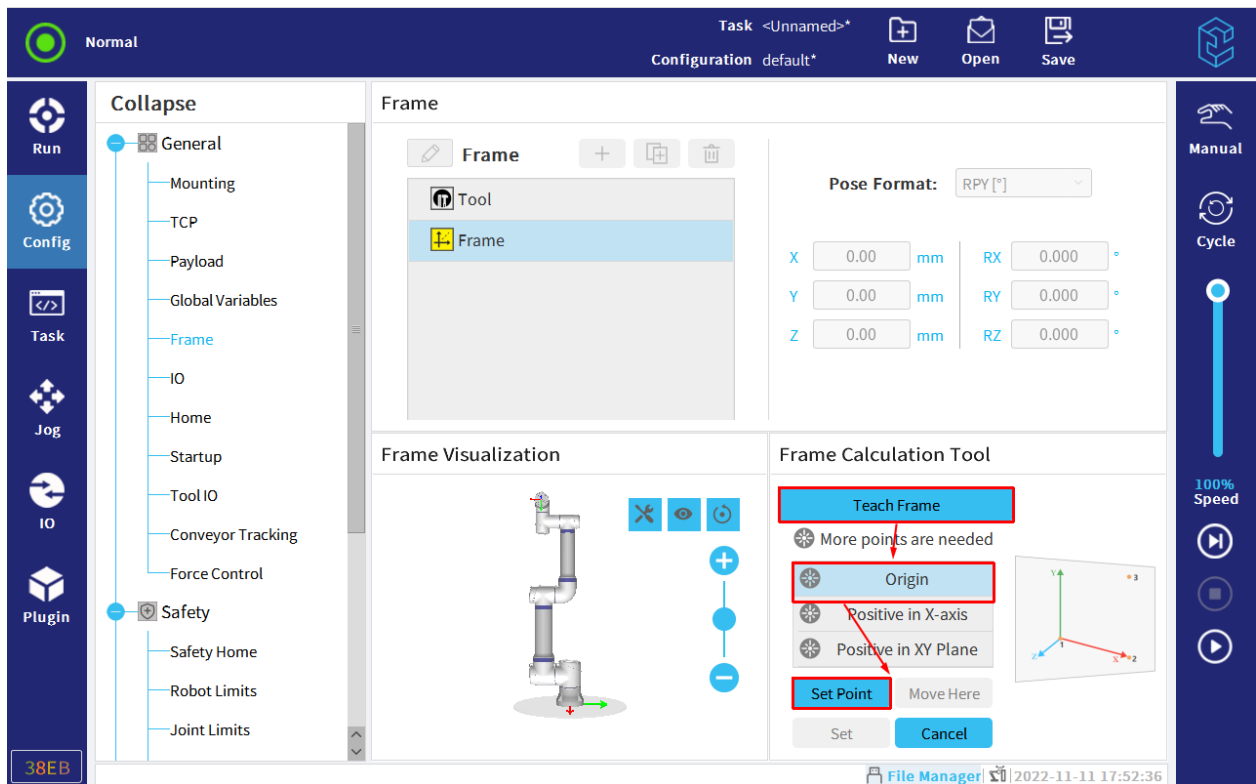

Figure 11-8 Set point

11 Configuration Tab

3. Set point, click "Accept" at the lower left.
4. Click "Positive in X-axis" and "Positive in XY Plane" in proper order to set the points.
5. Verify the calculated frame, click "Apply Teach Result" and apply in selected frame.



The user can click "Move Here" to check the three teach points. If points setting is unreasonable among three points, the user can click "Change Point" to re-teach the points.

TIPS



No modification on "Tool" frame.

11.1.5.2 Other

- Copy: Click  , copy tool or custom frame;
- Rename: Select frame, click  to rename;
- Delete: select the coordinate to be deleted, click  ;
- Modify: Click "Modify" to re-teach points or update the defined frame value directly;
- Reset: Roll back to original data before modification.

11.1.6 IO

The user can configure all IO signals, including name, configuration IO tab control and operation when triggered, as shown in Figure 11-9.

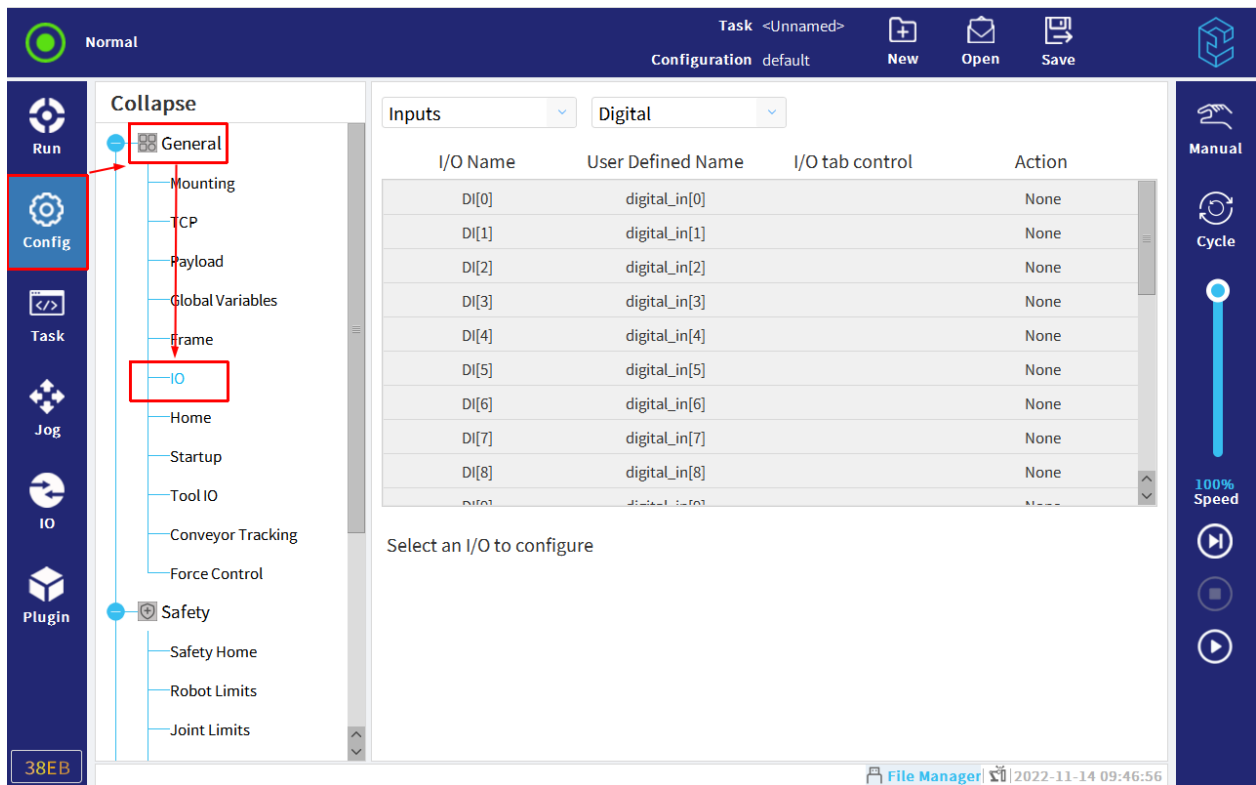

Figure 11-9 IO set

Caution: Tool analog input will be unavailable when Tool Communication Interface(TCI) start.

Types of IO signal are shown as below:

- Digital, configurable and tool;
- Analog;
- Modbus;
- General register (boolean, integer and float).

11.1.6.1 Configure IO Signal Type

The user can select "Input" or "Output" signals, and select the IO signal type to find the signal that needs modification, as shown in Figure 11-10.

Besides, Input signals and General Registers do not support configurations about I/O tab control.

11 Configuration Tab

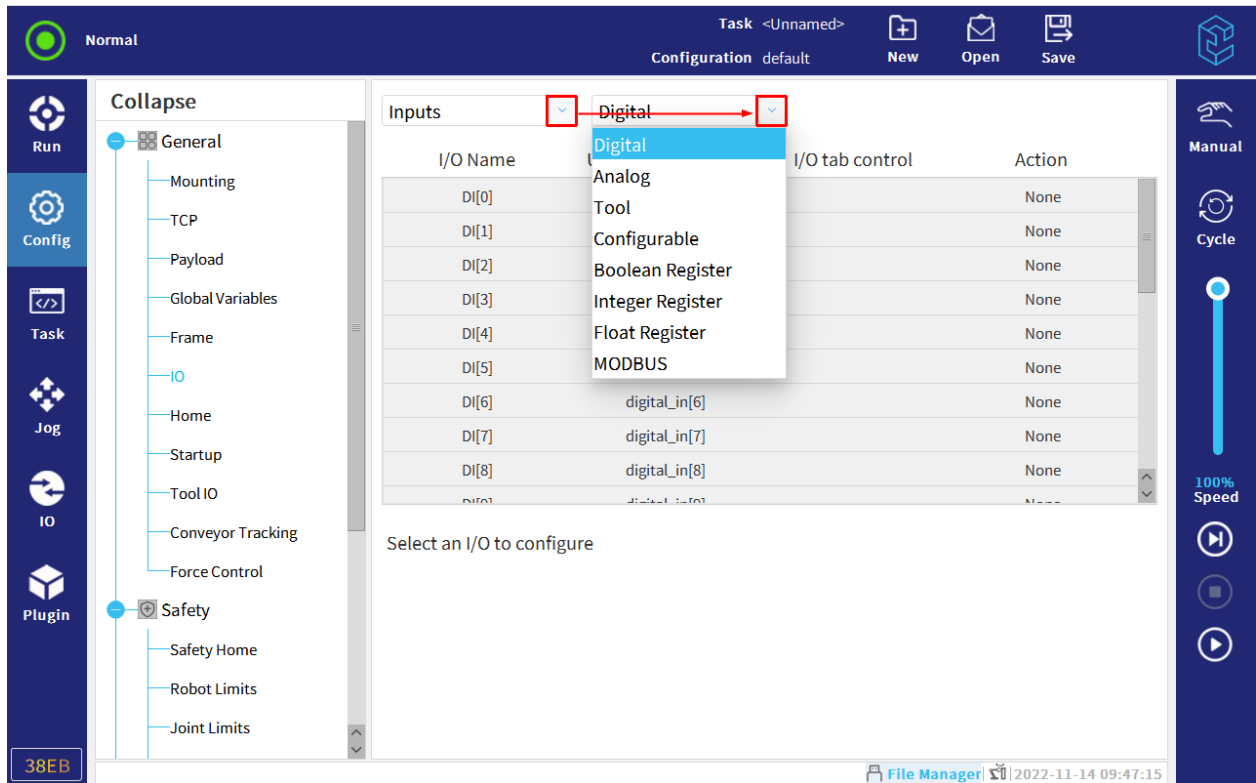

Figure 11-10 IO signal type

11.1.6.2 Configure IO Type as Digital, Configurable or Tool Input Signal

The user can modify the name of the input IO and set the operation of the robot when the signal is high, as shown in Figure 11-11.

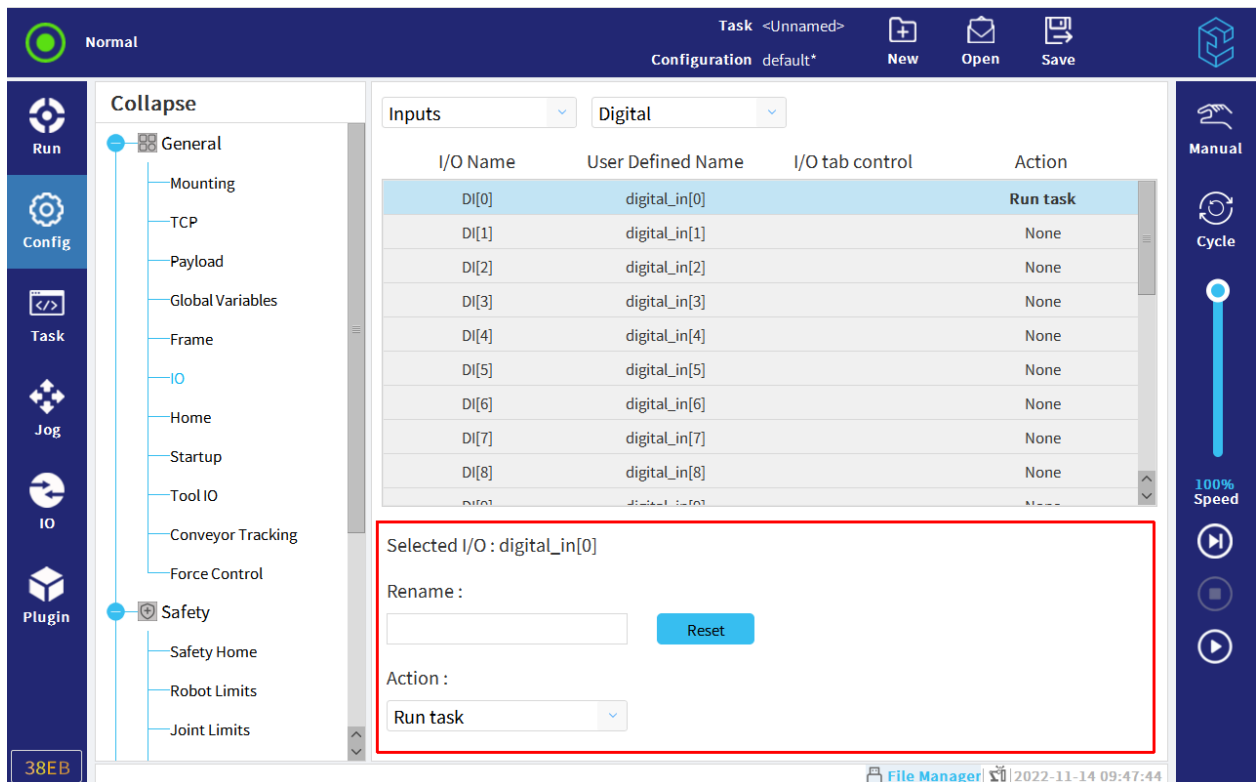

Figure 11-11 Digital input signal

The robot operation including:

- None: the robot has no operation;
- Run task: run current task upon a valid signal goes high;
- Stop task: stop currently running task upon a valid signal goes high;
- Pause task: pause currently running task upon a valid signal goes high;
- Free Drive: drive the robot upon a valid signal goes high.

Note: Modified name applies in task, it's recommended to relate the names to IO signals.

11.1.6.3 Configure IO Type as Digital, Configurable or Tool Output Signal

As show in Figure 11-12, the user can modify the name of the IO, status of IO and "IO Tab Control" when task is running.

11 Configuration Tab

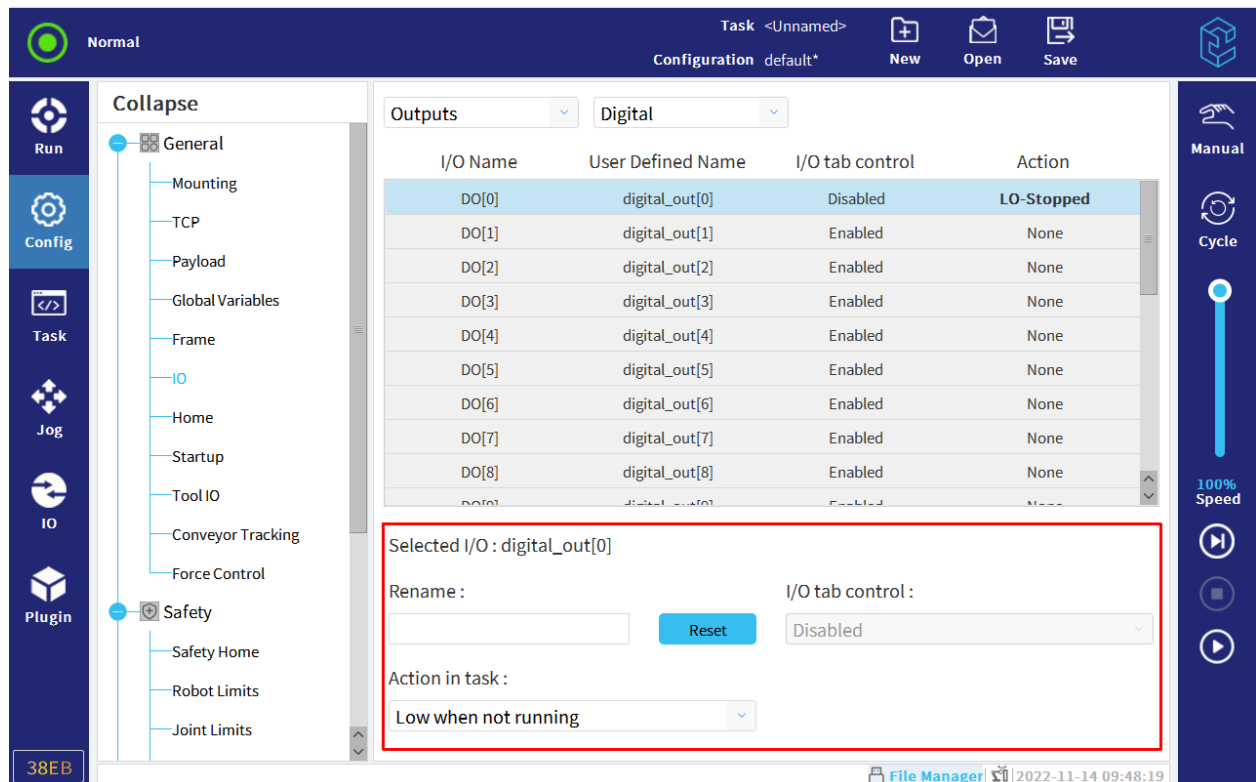

Figure 11-12 Digital output signal

"IO Tab Control" is divided into:

- Enable: under the IO tab, the status of the current output signal can be modified.
- Disable: under the IO tab, the status of the current output signal cannot be modified.
- Manual mode only: the current output signal can be controlled only in manual mode.

The operation of the robot including:

- Low when not running: when the task is not running, the output signal is low.
- High when not running: when the task is not running, the output signal is high.
- High when running-low when stopped: when the task is running, the output signal is high; when the task is not running, the output signal is low.
- Periodic pulse when running: the time length of high and low can be configurable.

11.1.6.4 Configure IO Type as Analog Output Signal

Compare to digital, configurable and tool output signals, Analog Output signals have different robot operation options, as shown in Figure 11-13.

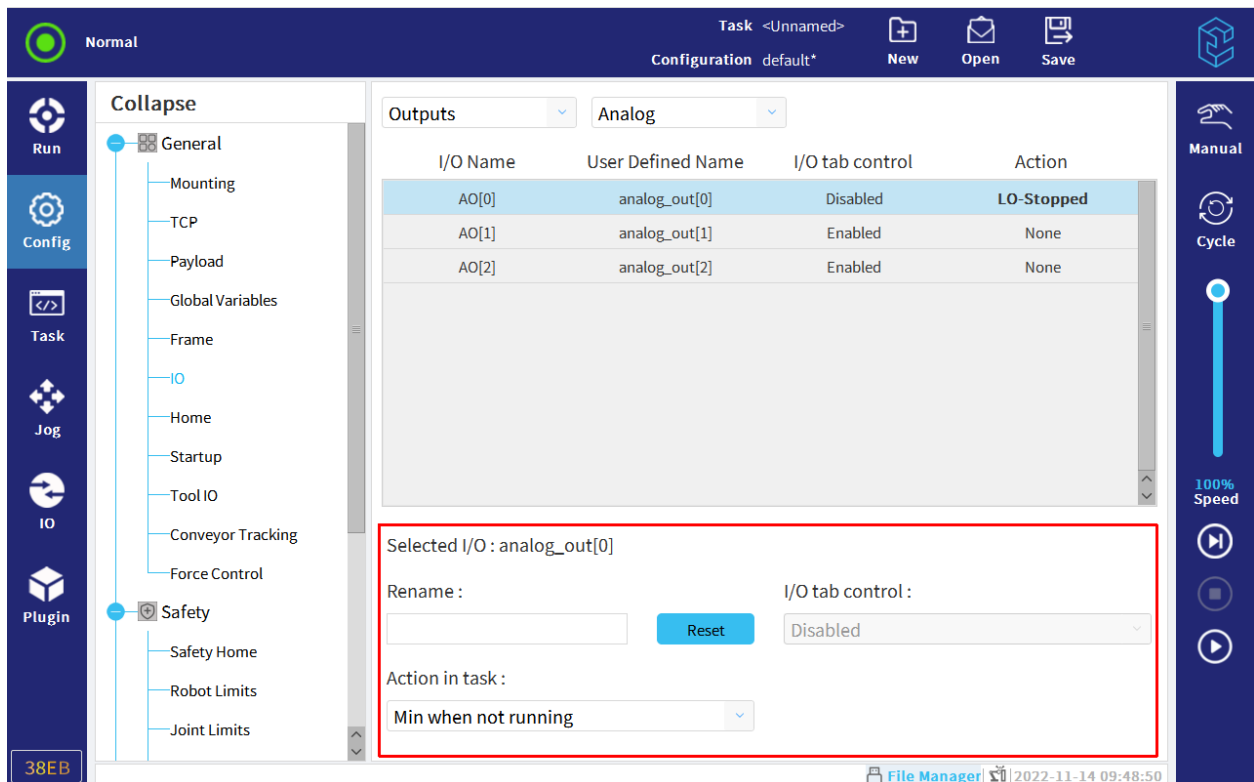

Figure 11-13 Analog output signal

Robot operation including:

- **Min when not running:** when the task is not running and in current mode, it is 4mA; In voltage mode, the value is 0V;
- **Max when not running:** when the task is not running and in current mode, it is 20mA; In voltage mode, the value is 10V;
- **Max when running-min when stopped:** the task is at high when running and low when stopping.

11.1.7 Home

The home is a reference point related to the robot operation. Theoretically, the home position can be set to any point inside the operation range of the robot, the home position must be at a point that never cause the robot to interfere with the fixture and workpiece, so the normal operation of the robot is not affected. The default joint coordinate for home position of CS robot is (0, -90, 0, -90, 90, 0). The home configuration is shown as Figure 11-14.

11 Configuration Tab

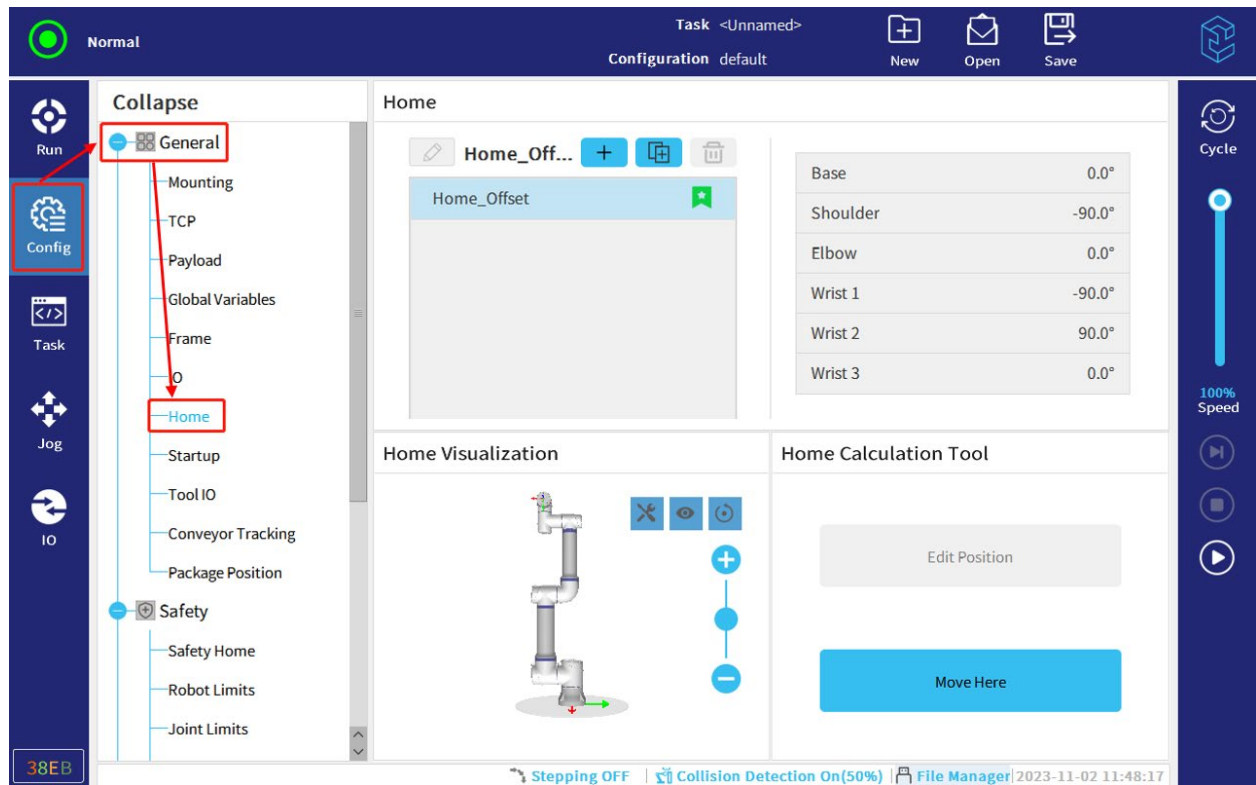



Figure 11-14 Home set

The operation steps of adding the home are as follows:

1. Click "Configure > General > Home".
2. Click  .
3. To configure the points, please refer to Chapter 14 for details.
4. Click "Accept" at the bottom left to add the home.

TIPS



Changing "Home_Offset" is not available.

11.1.8 Startup

Startup refers to the setting of automatic add-on, including starting the default task and automatically initializing the robot arm when starting, as shown in Figure 11-15.

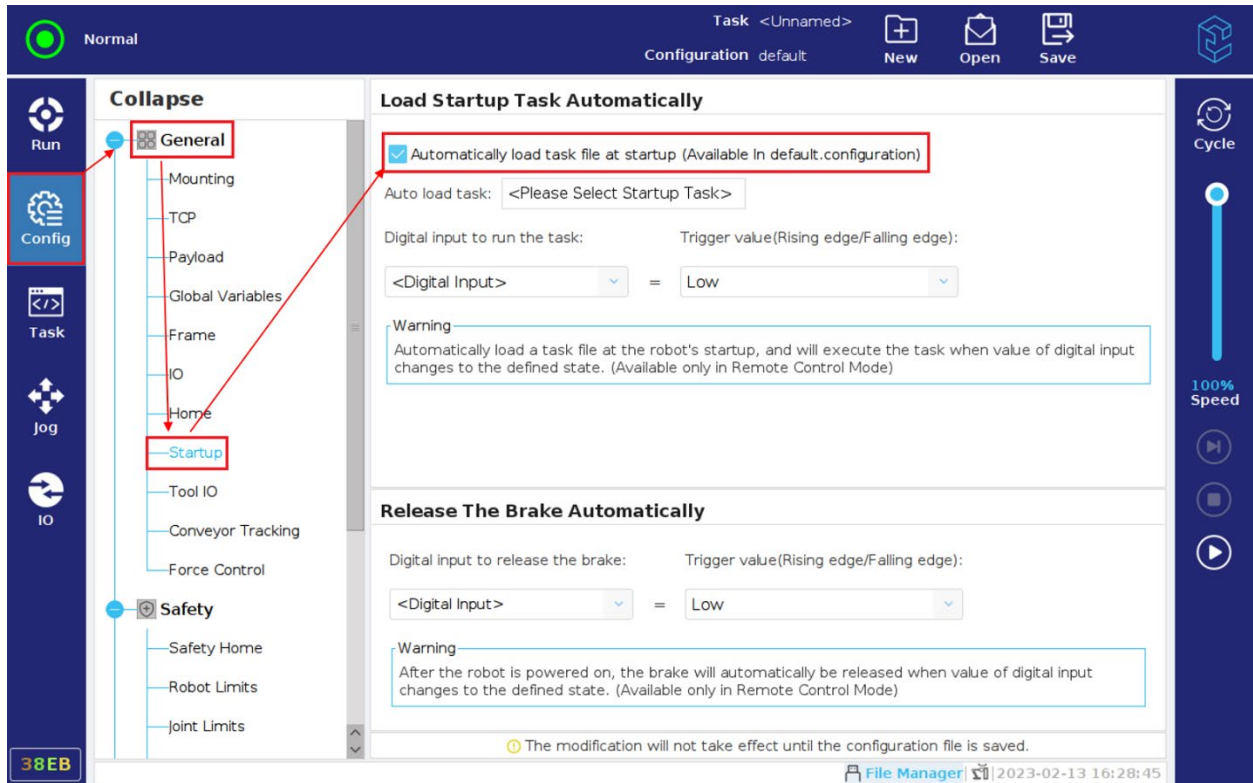

Figure 11-15 Startup

WARNING



1. When Auto Load and Release The Brake Automatically are enabled, as the input signal matches the selected signal value, the robot will run the tasks immediately after powering on controller.
2. Please be careful when the signal is set to low. When the input signal is set to low as default, the tasks will run automatically and ignore the external control.
3. Before running the tasks that enabled Auto Load or Auto Initialize, the robot must be in "Remote Control Mode".

- Auto load task:

Check "Automatically load task file at startup (Available in default.configuration) ", set trigger conditions, that is, set "Digital Input" and "Value", and add a task by clicking the box in the right side of "Auto load task" after the robot startup.

After the robot starts, it will automatically load the set tasks. When the digital input changes and meets the input conditions, the robot will automatically execute the task.

11 Configuration Tab

Note: If the selected startup task file disappears for some reason, the checkbox will turn yellow after start.

- Auto initialize:

After setting "Digital Input" and "Value", when the digital input meets the input conditions, the robot will automatically release the holding brakes, and the user can move the robot.

11.1.9 Tool IO

The user can configure the working mode of tool IO, as shown in Figure 11-16. For details of tool IO, please refer to section 6.5.

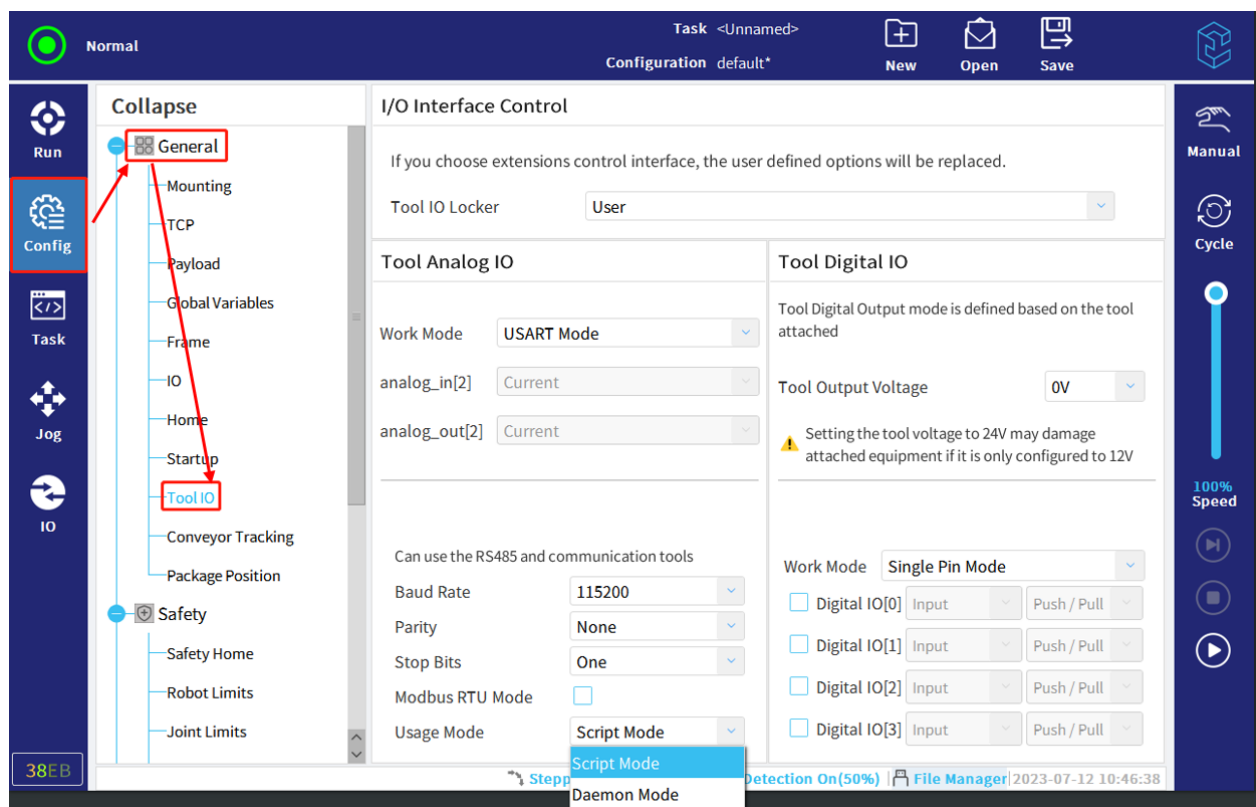

Figure 11-16 Tool IO

11.1.9.1 Tool Analog IO

Communication Interface:

The tool connector provides a serial interface for communicating with the tool using RS485 protocol. Once the tool communication interface is enabled, the tool analog input and analog output are unavailable.

Configure Tool Communication Interface(TCI):

1. Click "Config > General > Tool IO" to enter the "Tool Analog IO" interface, as shown in Figure 11-17.

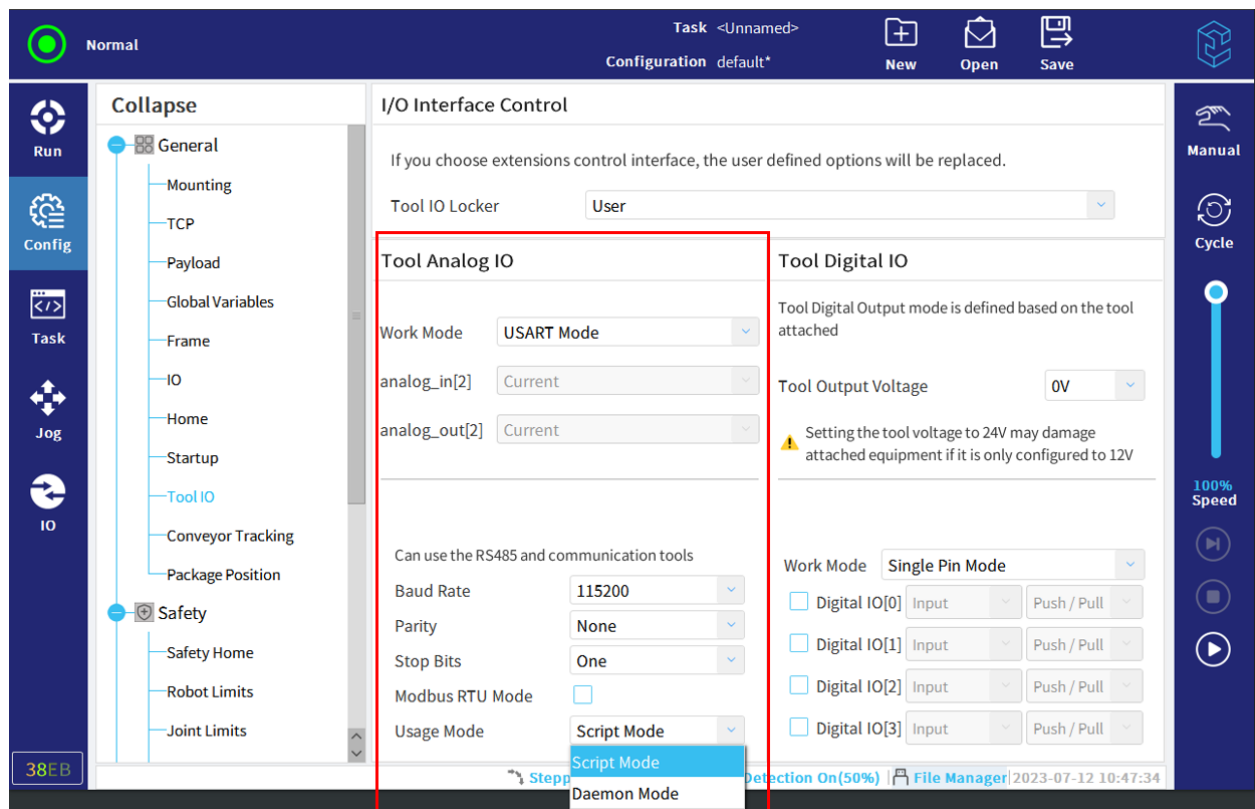

Figure 11-17 Tool analog IO

2. Click "USART Mode" to set TCI.

When TCI is enabled, tool analog input is not available for configuration in "Config > General > Tool IO" and does not appear in the input list.

3. Click the desired value from the drop-down menu of the communication interface.

11 Configuration Tab

The user can select and set baud rate, parity, stop bits and other values from the drop-down menu of the communication interface. Any change in the value is immediately sent to the tool. If it is different from the value used by the tool, a warning message will appear.

4. Select the desired mode from the drop-down list on the right side of the “Usage Mode” .

The user can select “Script Mode” or “Daemon Mode” as required. Once the “Daemon Mode” is selected, the interface ttyTCIO will be enabled to help the user to visit the device via the plugin.

Note: If Modbus RTU mode is not checked, RS 485 mode is selected by default; If checked, it becomes Modbus RTU mode.

11.1.9.2 Tool Digital IO

The tool IO can provide 0V, 12V or 24V power supply to the external tool, which means the tool output voltage can be selected from 0V, 12V or 24V. The working mode can choose from Single Pin Mode, Dual Pin Mode 1, Dual Pin Mode 2 or Three Pin Mode. The tool communication interface can set 4 digital IO separately as shown in Figure 11-18.

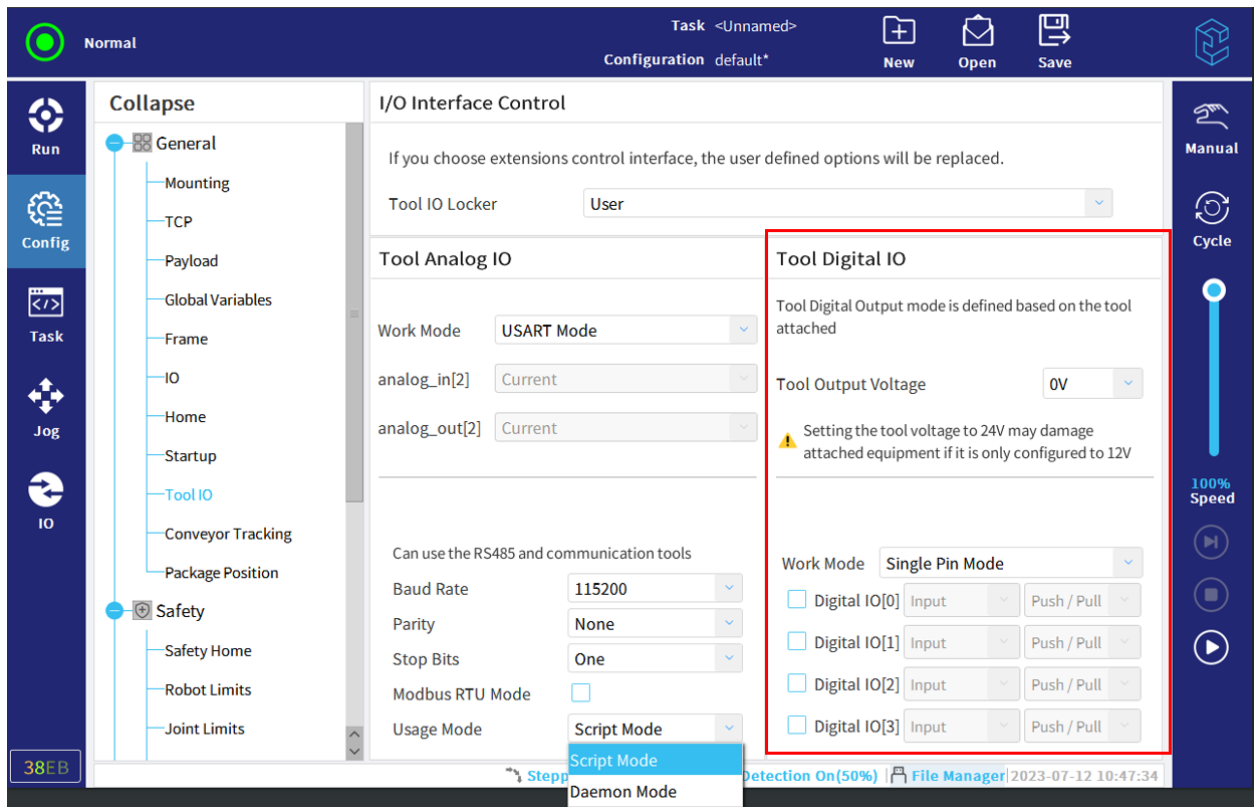

Figure 11-18 Tool digital IO

Besides, the digital output has the following options:

- **Sinking NPN:** sets the pins to NPN mode. When the output is off, the pin allows current to flow to the ground. When used in combination with PWR pins, a complete circuit can be created;
- **Sourcing PNP:** sets the pins to PNP mode. When the output is on, the pin provides a positive voltage source (Chapter 13 covers configuration). When combined with GND pin, a complete circuit can be created;
- **Push / pull:** when the output is on, the pin provides a positive voltage source (Chapter 13 covers configuration). When combined with GND pin, a complete circuit can be created. When the output is off, the pin allows current to flow to the ground.

Note: After modifying the output configuration, the modification takes effect immediately.

11.1.10 Conveyor Tracking

Conveyor tracking supports up to two conveyors at the same time.

Configure the conveyor tracking parameters as follows:

1. Click "Config > General > Conveyor Tracking" to enter the "Conveyor Tracking Setup" interface.
2. Click "Enable conveyor tracking" in the upper right corner.
3. Set "Encoder Type" as "Absolute".
4. Select "Variable encoder count" as the Modbus slave connected in "General > Communication > Modbus", as shown in Figure 11-19.

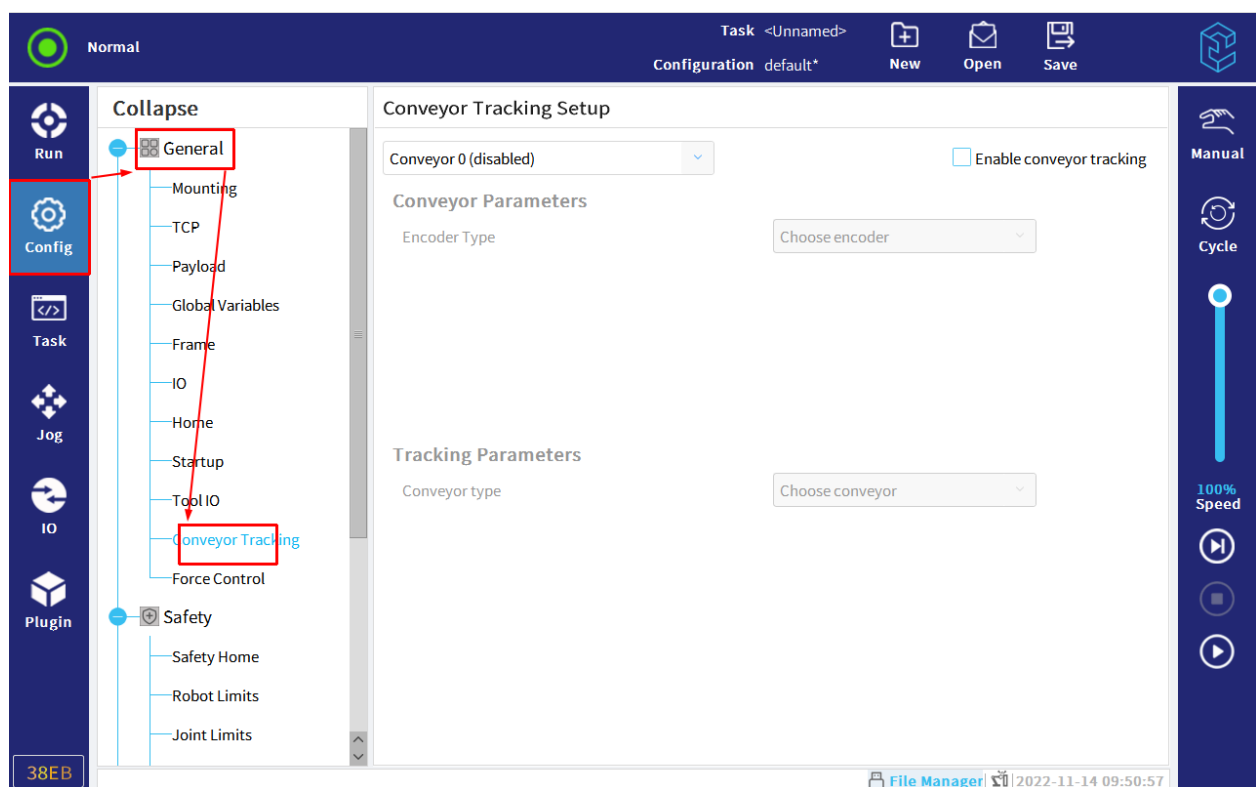

Figure 11-19 Conveyor tracking

5. Set "Tracking Parameters" and select "Conveyor type" as "Linear" or "Circular", as shown in Figure 11-20.

- Linear:
 - "Ticks per inch" is determined by external hardware equipment;

- Click "Frame" as the frame taught by “Config > General > Frame” and specify which direction to run in (determined by axes X, Y, Z and whether to reverse).
- Circular:
 - "Ticks per inch" is determined by external hardware equipment;
 - Click "Frame" as the frame taught through “Config > General > Frame”. By default, it rotates in a positive direction around the Z axis of the frame.
 - Check "Rotate tool and conveyor", that is, rotate the end tool to follow the target conveyor and keep the object's grasping position unchanged.

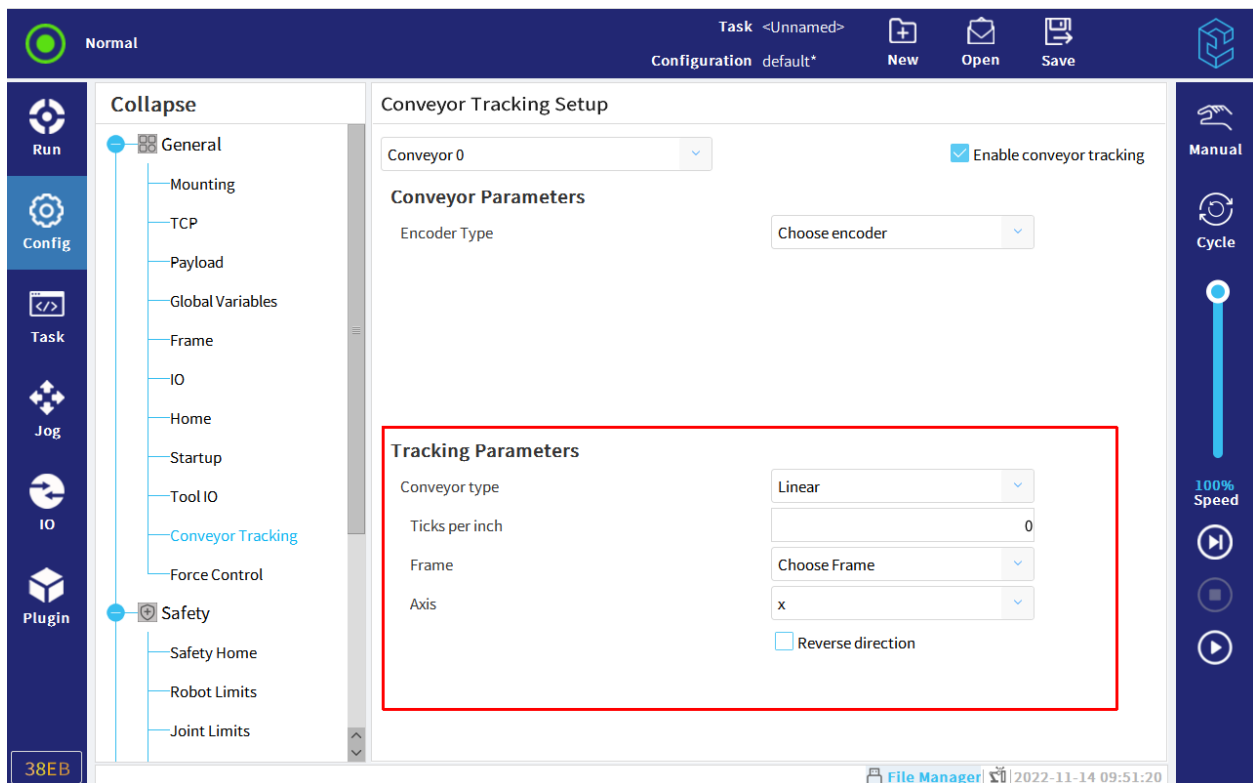

Figure 11-20 Set tracking parameters

11.1.11 Package Position

Click “Config > General > Package Position” to enter the settings, as shown in Figure 11-21.

11 Configuration Tab

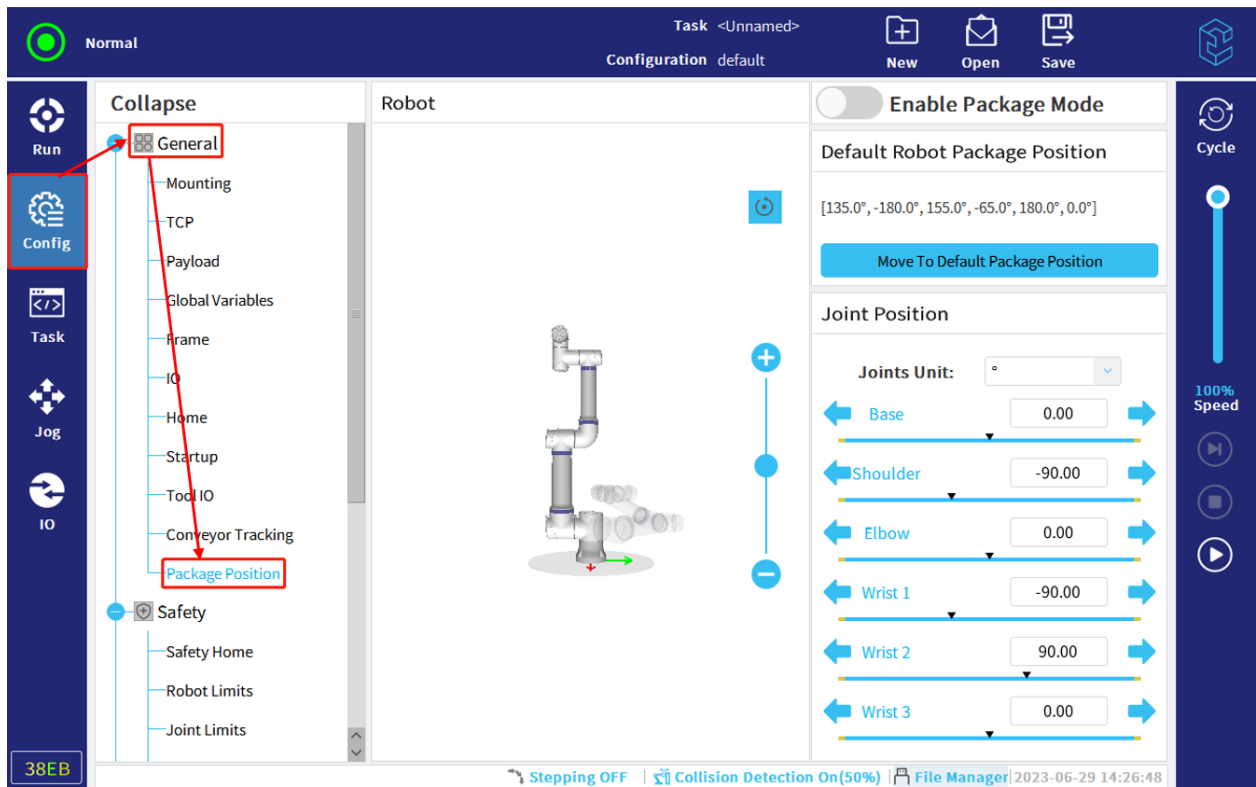

Figure 11-21 Settings

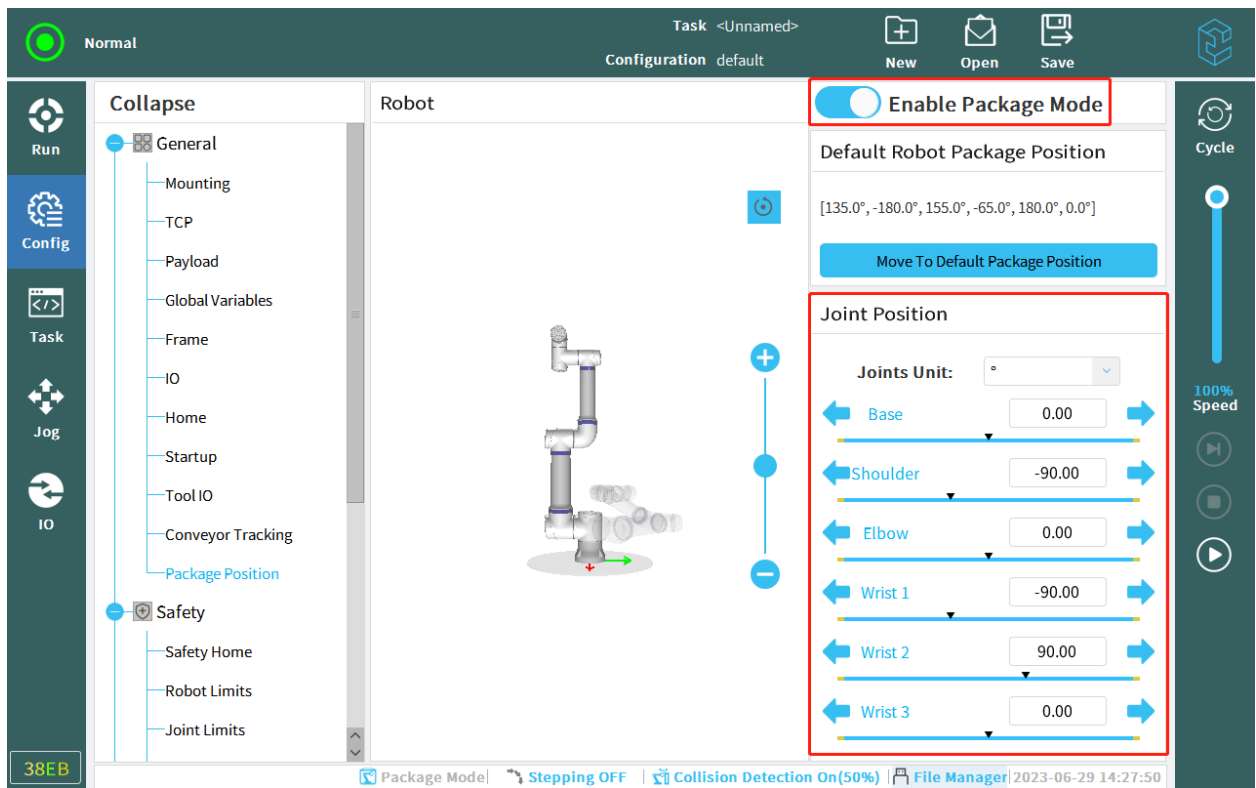



Figure 11-22 Package mode

Click “Move To Default Package Position” to enter the auto move interface. The robot will move to the package position. The user can enable the package mode when the robot cannot reach the package position due to the safety plane, the joint range and other data settings. In the package mode, the safety plane and the joint range will not restrict on the robot movement. The robot can move to the package position which is out of the joint range. After exiting from the package position page, the system will automatically exit from the package mode.

11.2 Safety

This section describes the configuration of robot safety parameters and precautions.

Click  on the right of the status and menu bar, choose "Settings > Password > Safety", and set a safety password to unlock safety configuration parameters.

TIPS



Before modifying the safety configuration, the user needs to enter the safety password to unlock the safety configuration.

11.2.1 Safety Home

The safety home is a user-defined home position, as shown in Figure 11-23. User can select the reference home to set the safety home parameters, as shown in Figure 11-24.

11 Configuration Tab

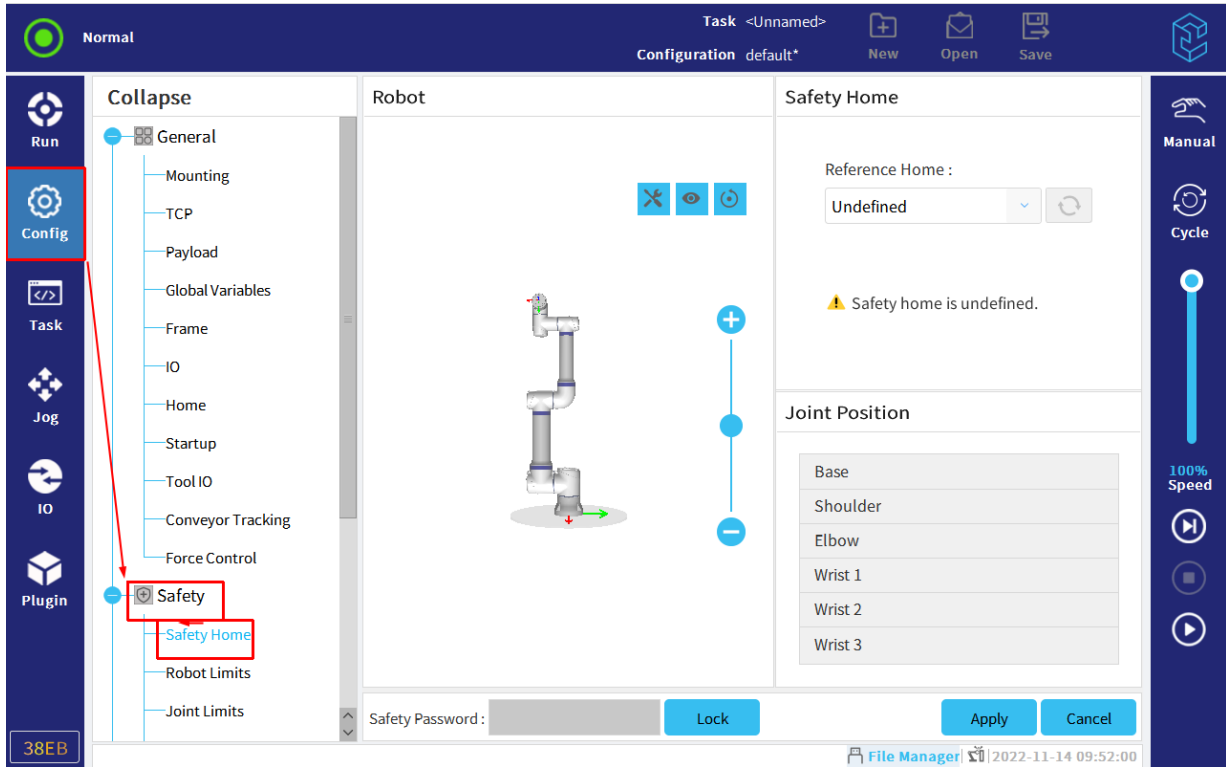

Figure 11-23 Safety home

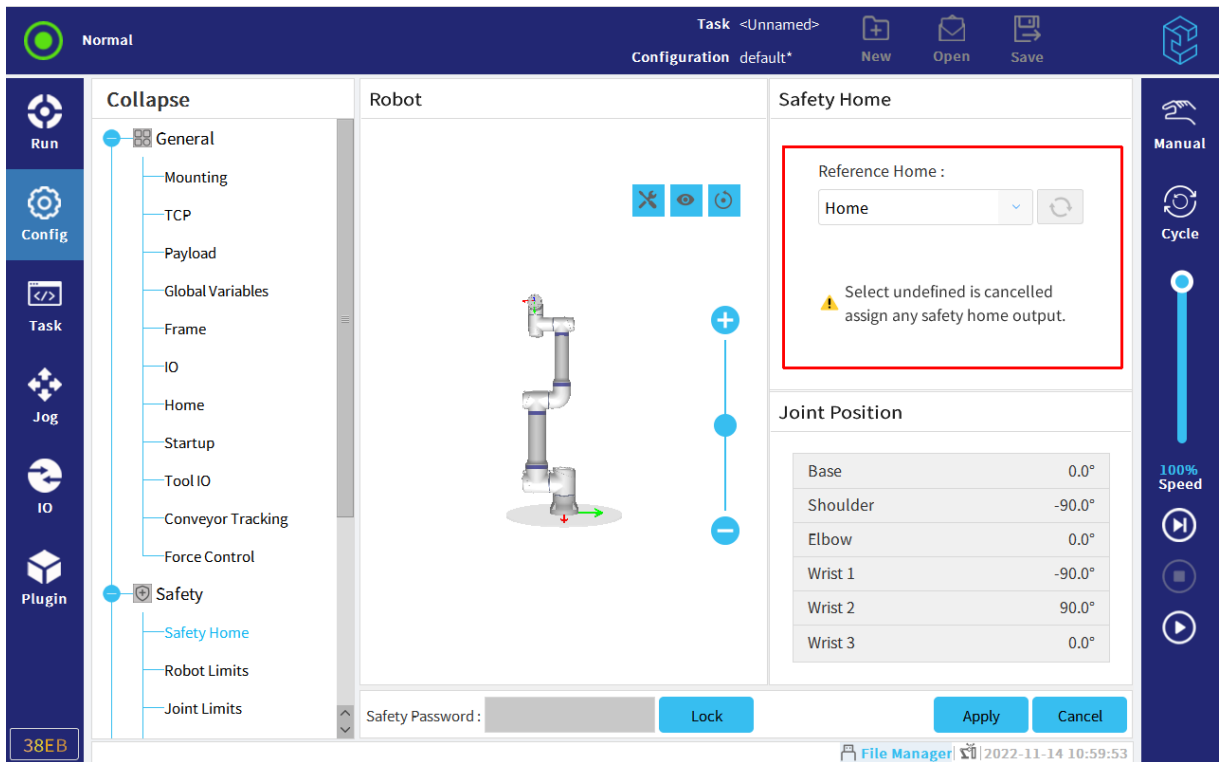

Figure 11-24 Reference home

11.2.2 Robot Limits

Robot limits are used to limit robot related safety parameters. The robot limit screen has five configuration options: Least Restricted, 2nd Least Restricted, 2nd Most Restricted, Most Restricted and Custom Restricted. Only the "Custom Restricted " option allows the user to modify the limit parameter of the robot. Parameters are shown in Figure 11-25.

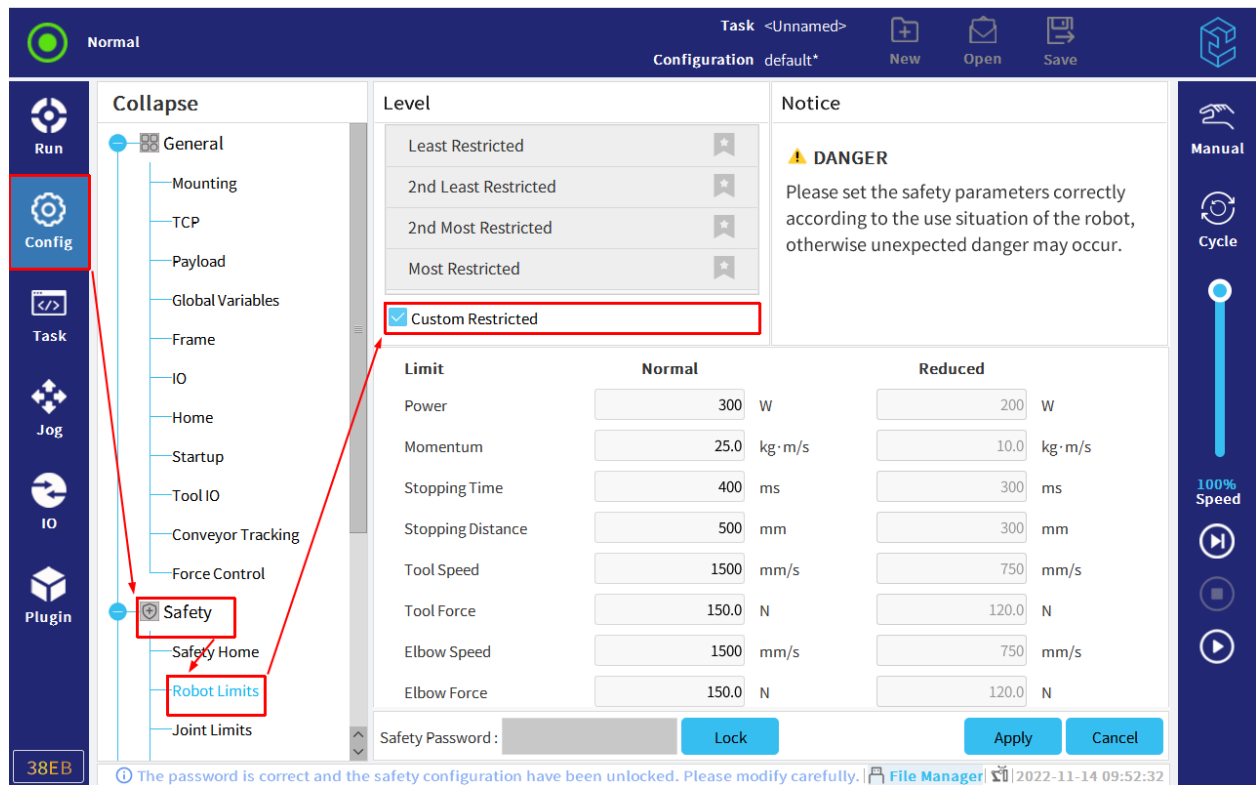

Figure 11-25 Robot limits

The parameter setting description is as follows:

- Stopping Time: limits the maximum time that takes robot to stop from moving;
- Stopping Distance: limits the maximum distance that the robot tool can move before stopping;
- Tool Speed: limits the maximum speed that the robot tool moves;
- Elbow Speed: limits the maximum speed that robot elbow moves.

Note: When setting the robot limit parameters, the values in the normal mode is larger than the values in the reduced mode.

11.2.3 Joint Limits

Joint limits are used to limit the range of motion and the maximum angle of each robot in joint space.

In the "Joint limits" interface, there are two joint limiting options: position range and maximum speed, as shown in Figure 11-26.

- Position range defines the position range of each joint;
- Maximum speed defines the maximum angular speed of each joint.

Note: When setting the position range, the difference between the maximum and minimum values should be at least 7°, and the range value in reduced mode must not exceed the range value in normal mode.



REMINDE If there is no safety plane that triggers the reduced mode, that is, the "Limit" in the safety plane is not configured as "Trigger Reduced Mode", or there is no configurable input IO configured as "Reduced Mode" in the "Safety IO", the parameters of the reduced mode cannot be modified.

The screenshot shows the configuration interface for joint limits. The left sidebar has a 'Config' button highlighted in red. Below it, a tree view shows 'Safety' and 'Joint Limits' also highlighted in red. The main area is divided into two sections: 'Position Range' and 'Maximum Speed'. Both sections have tables for 'Normal Mode' and 'Reduced Mode' settings for various joints.

Joints	Range	Normal Mode		Reduced Mode		
		Minimum	Maximum	Minimum	Maximum	
Base	-363 — 363 °	-363	363	-363	363	+2° / -2°
Shoulder	-363 — 363 °	-363	363	-363	363	+2° / -2°
Elbow	-363 — 363 °	-363	363	-363	363	+2° / -2°
Wrist 1	-363 — 363 °	-363	363	-363	363	+2° / -2°
Wrist 2	-363 — 363 °	-363	363	-363	363	+2° / -2°
Wrist 3	-363 — 363 °	-363	363	-363	363	+2° / -2°

Joints	Maximum	Normal Mode	Reduced Mode	Tolerance
Base	150 °/s	150	130	+10 °/s
Shoulder	150 °/s	150	130	+10 °/s
Elbow	180 °/s	180	160	+10 °/s
Wrist 1	230 °/s	230	210	+10 °/s
Wrist 2	230 °/s	230	210	+10 °/s
Wrist 3	230 °/s	230	210	+10 °/s

At the bottom, there is a 'Safety Password' field with 'Lock', 'Apply', and 'Cancel' buttons. A status bar at the very bottom indicates: 'The password is correct and the safety configuration have been unlocked. Please modify carefully. | File Manager | 2022-11-14 10:58:51'

Figure 11-26 Joint limits

11.2.4 Safety I/O

The IO between the input and output terminals are separated and appear in pairs, as shown in Figure 11-27.

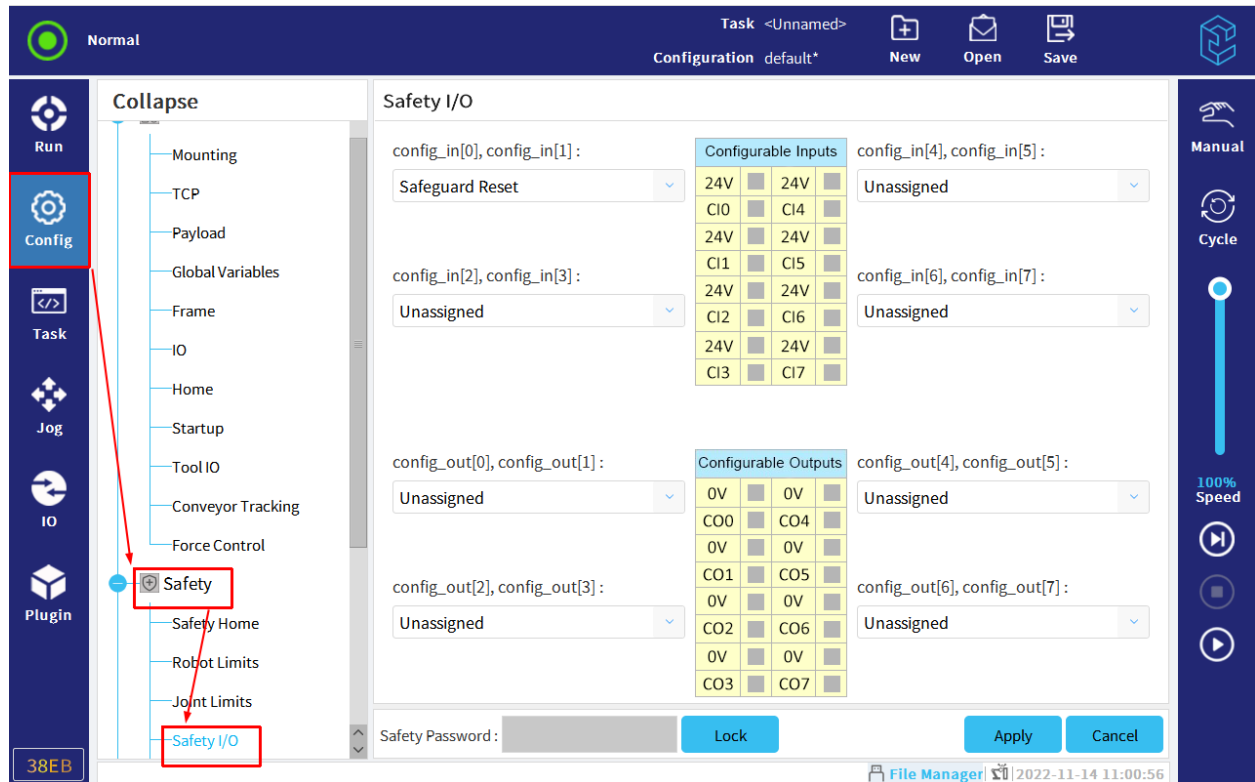

Figure 11-27 Safety IO

11.2.4.1 Input Signal

As shown in Figure 11-28, the following safety functions can be used with input signals:

- **Emergency Stop:**
Select the input signals as "Emergency Stop", which will be active on low. When input signals are low, the robot enters "Emergency Stop" state; when the input signals are the combination of a high signal and a low signal, the robot gives an alarm; when both signals are high, the robot operates normally.
- **Safeguard Reset:**
Safeguard Reset is used for the user to manually release the safeguard stop state. After releasing, the running task suspended by safeguard stop will be resumed.

11 Configuration Tab

- **Reduced Mode:**

Select the input signals as "Reduced Mode", which will be active on low. When the input signals are low, the robot enters "Reduced Mode"; when the input signals are the combination of a high signal and a low signal, the robot gives an alarm; when both signals are high, the robot operates in "Normal Mode".

- **3-Position Switch:**

This tab configures the controller with external three-position switch through configurable safety IO and implements the function of the three-position switch.

Note:

1. The three- position switch function is valid only in manual mode.
2. When the three-position switch is not enabled, the robot will be in the safeguard stop state.
3. After setting the three-position switch, the manual high-speed function can be turned on to realize the real-time adjustment of speed limit when the program is running in manual mode.
4. After the three-position switch is configured, the manual mode and automatic mode switchover functions are automatically enabled. If a password is set for mode switchover, the user needs to enter the password. If no password is set for mode switchover, the user doesn't need to enter the password for mode switchover.
5. In manual mode, before entering the jog page to teach the robot, the three-position switch needs to be pressed first.

- **Operation Mode:**

This tab is used for switching the system between manual mode and automatic mode. The user can use the safety IO to switch the mode with external selective switch.

Note:

1. After the operation mode input is configured in the safety IO, the system enters the automatic mode immediately because the safety IO input is low by default.
2. The automatic mode triggered by safety IO no longer supports manual modification through the interface. The manual and automatic mode is switched through the safety IO, and the mode password is no longer required.
3. In the simulation environment, if the user set the operation mode to stuck in auto mode by mistake, restart the simulation software is a solution. When the software

is powered on for the first time, if the safety IO operation mode is set to manual mode by default (even if the current safety IO input is low), the user can remove the safety IO operation mode.

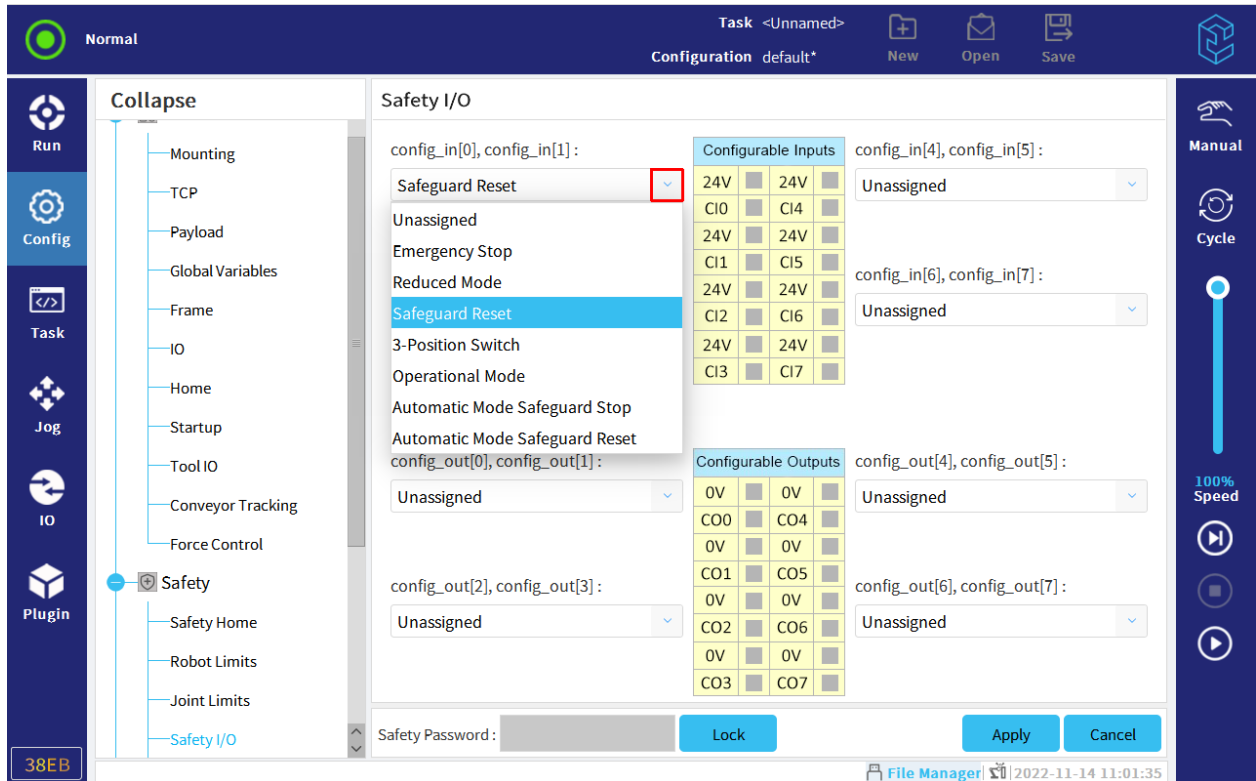

Figure 11-28 Input signal

11.2.4.2 Output Signal

As shown in Figure 11-29, the following safety functions can be applied to the output signal. After the state that triggers signal to be high had ended, the signal return to low status.

- **System Emergency Stop:**
When the robot is in the emergency stop state (only when the emergency stop button is pressed), the low-level signal will be triggered, and the high level signal will be triggered in other cases (even if the emergency stop of the system is triggered through the safety IO).
- **Robot Moving:**
Low signals are given as long as the robot arm is in the moving state, and high signals are given when the robot arm is in a fixed position.

11 Configuration Tab

- **Reduced Mode:**
When the robot body is in reduced mode, or the safety input is configured with "reduced mode" input and the current signal is low, the low signal will be sent. Otherwise, the signal is high
- **Non-reduced Mode:**
Contrary to the above reduced mode.

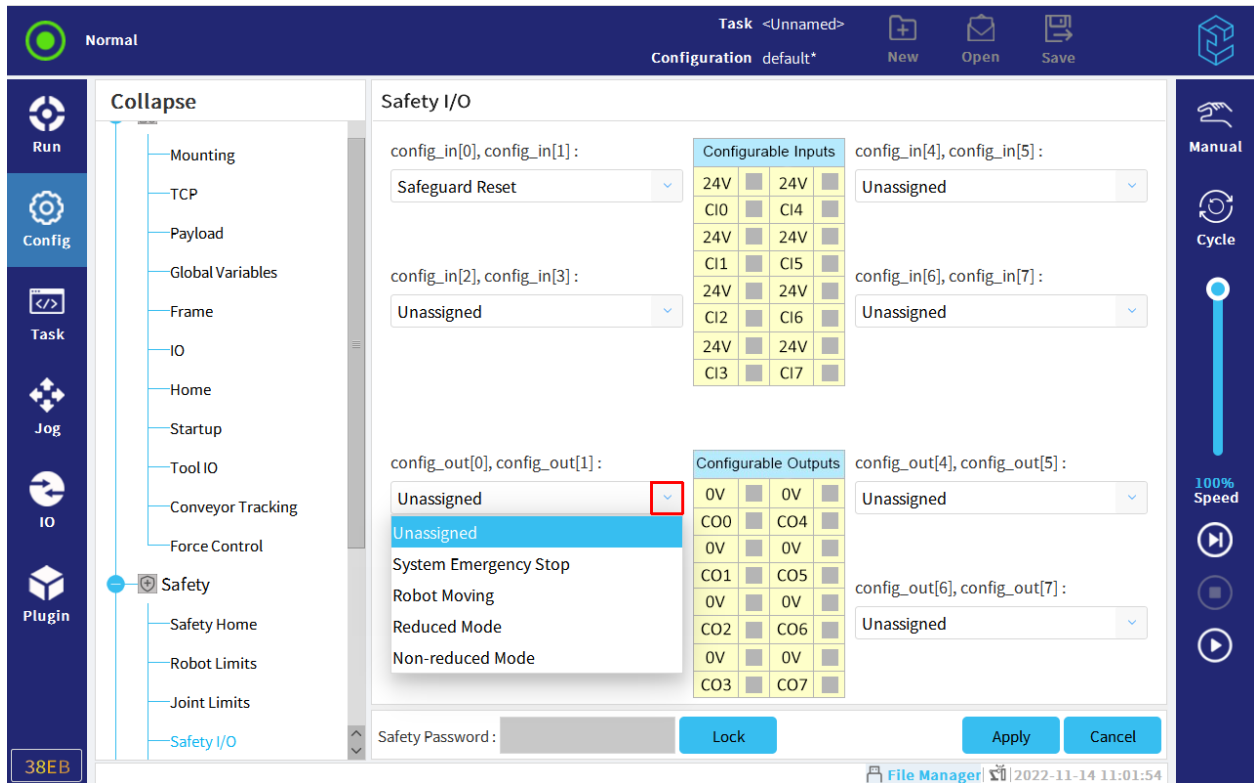

Figure 11-29 Output signal

11.2.5 Safety Plane

REMINDE



The safety plane is configured based on the frame. Before configuring the safety plane, we recommend the user to create all frames.

The safety plane limits the workspace of the robot. Users can define up to eight safety planes to limit robot tools and elbows.

WARNING



The safety plane only limits the tools and elbows of the robot arm, and has no impact on the overall limit of the robot arm.

11.2.5.1 Modes

Users can use the following icons to configure restrictions for each plane.

11.2.5.2 Configuration Safety Planes

1. Select "Config > Safety > Safety Planes" and click  , as shown in Figure 11-30.

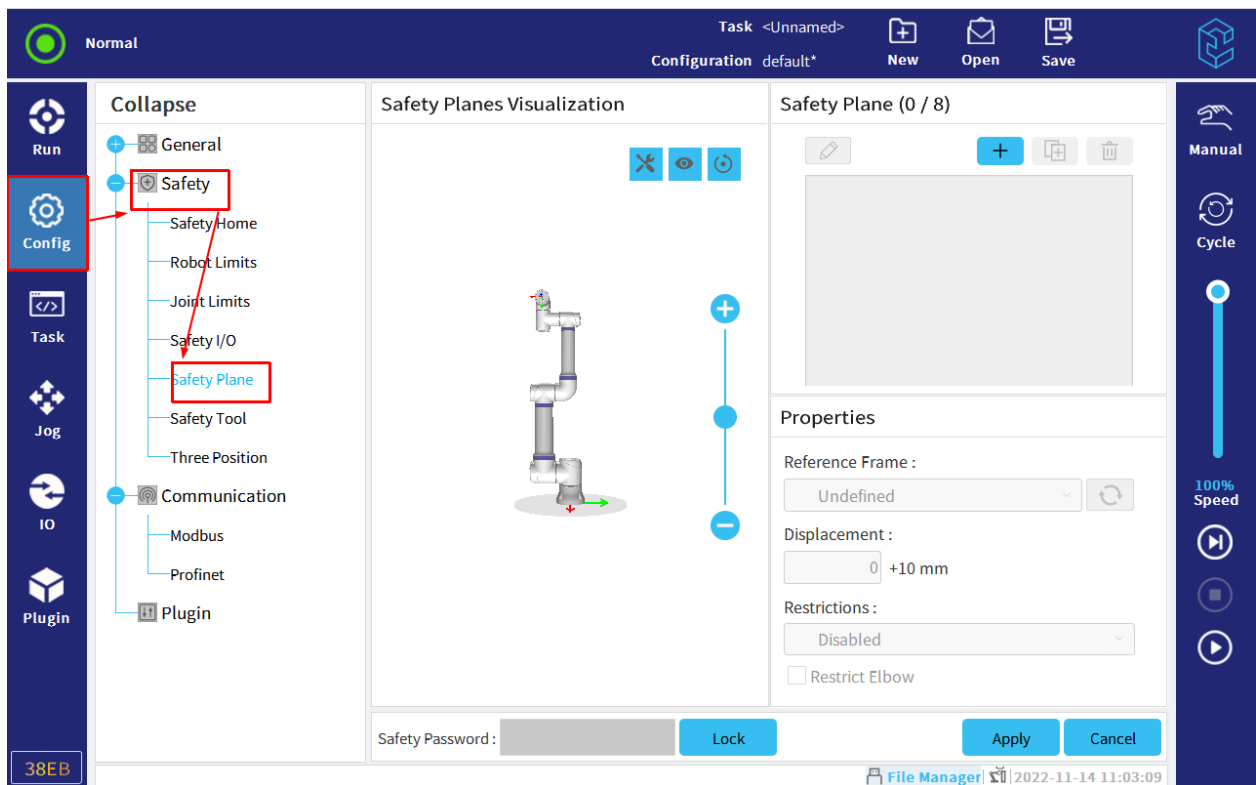

Figure 11-30 Safety planes

2. In the attribute field at the lower right corner of the screen, set reference frame, displacement, and restrictions.





11 Configuration Tab

- **Reference Frame:** users can select the base and the frame defined in “Config >General > Frame”, It's recommended to create Frame first, then use the Frame to configure Safety Planes.
- **Displacement:** If the user enters a number in "Displacement", it indicates the moving distance relative to the Z axis of the selected frame. For example, if the frame is selected as "Base", and the displacement is 200, then the coordination of safety plane is the frame that moved 200mm on Z axis from the base frame.
- **Restrictions:** the user can configure restrictions for each safety plane.
 - **Disabled:** in this state, the safety plane is never activated;
 - **Normal mode valid:** when the robot is in "Normal" mode, the safety plane takes effect. When the robot tool or elbow contacts or exceeds the safety plane, the robot stops protectively;
 - **Reduced mode valid:** when the robot is in "Reduced" mode, the safety plane takes effect. When the robot tool or elbow contacts or exceeds the safety plane, the robot stops protectively;
 - **Normal & Reduced mode valid:** when select "Both", the safety plane takes effect when the robot is in "Normal" mode or "Reduced" mode. When the robot tool or elbow contacts or exceeds the safety plane, the robot stops protectively;
 - **Trigger Reduced mode:** when the robot tool or elbow contacts or exceeds the safety plane, the system switches to reduced mode.

Note: If "Restrict Elbow" is checked, the safety plane will limit the elbow of the robot arm.

Under "Frame", if the frame defined in “Config > General > Frame" is modified, the warning icon appears to the left of the "Frame" text. However, the frame of the safety plane is still the frame before modification and will not be modified synchronously.

11.2.5.3 Other

- **Add:** Click  to create a new safety plane;
- **Copy:** Click  to copy the selected safety plane;
- **Rename:** select the safety plane to rename and click  ;
- **Delete:** select the safety plane to delete and click  .

11.2.6 Safety Tool

In the safety tool, you can add, copy, and delete safety tool items, as shown in Figure 11-31. One of the tool flanges is inoperable by default, and the default radius of the tool flange and TCP position are 0.

You can choose TCP in the general configuration as the basis for defining the location of the new safety tool. Properties at the bottom right of the interface are based on the select TCP. When the value in the edit location field is changed on this basis, the TCP name appearing in the drop-down menu will change to custom tool, indicating that there is a difference between the copied TCP and the actual limit input. The visualization of the safety tool will also display the status attributes of the corresponding tool.

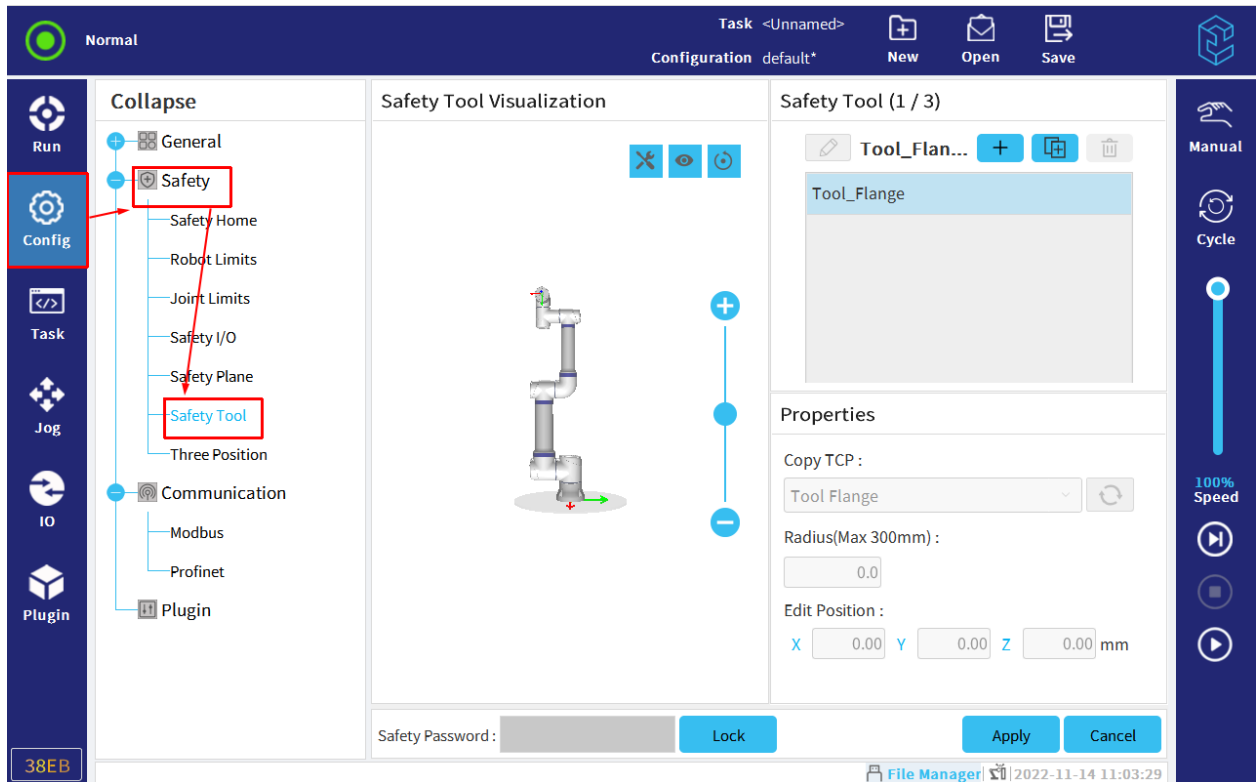

Figure 11-31 Safety tool

11.2.7 Three Position

Set whether the three position switch allows manual high speed, as shown in Figure 11-32.

11 Configuration Tab

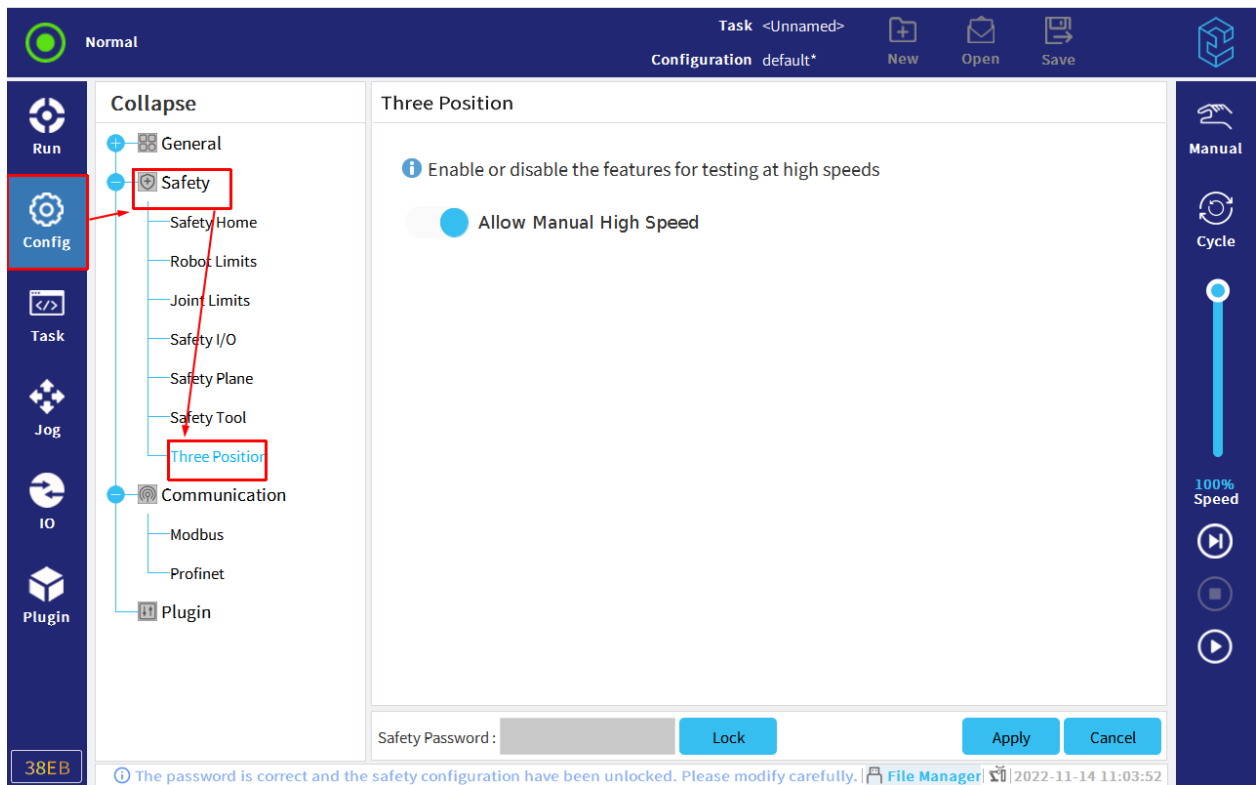

Figure 11-32 Three position

11.2.8 Hardware

In the hardware settings, the user can select "None" or "Standard Teach Pendant" from the drop-down list, as shown in Figure 11-33.

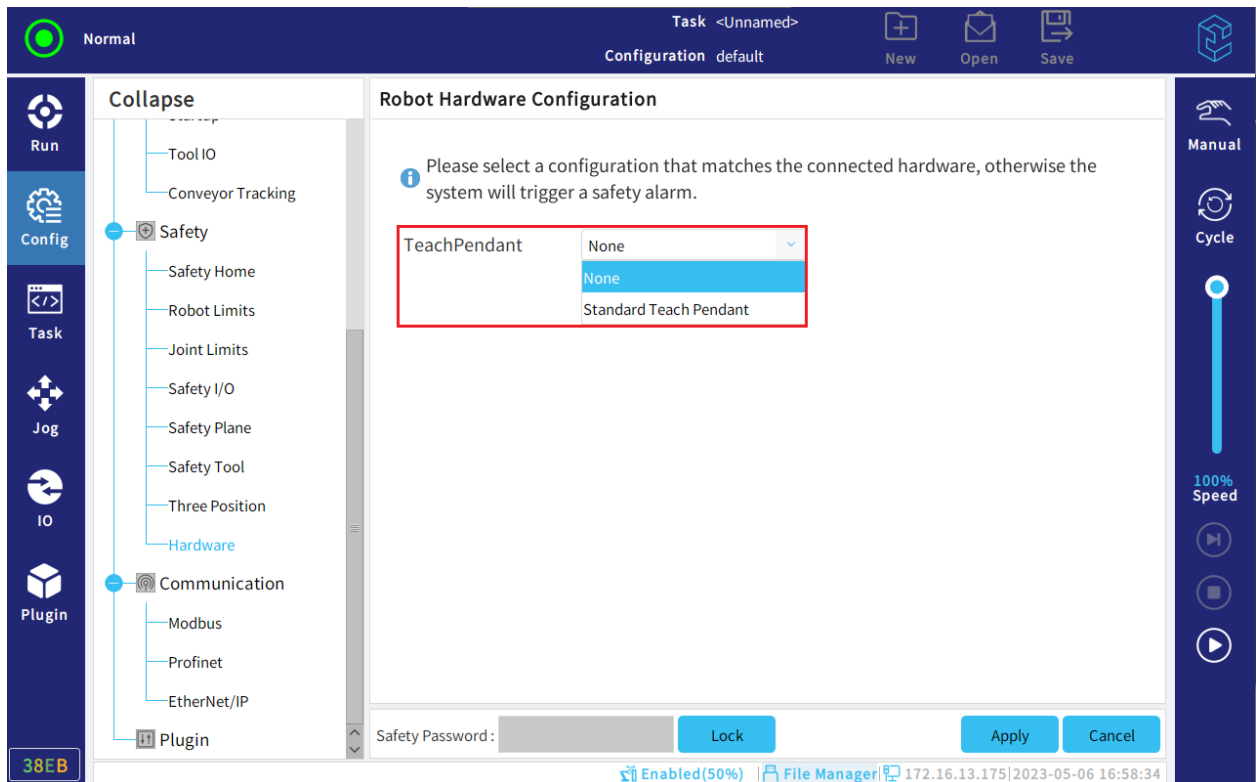

Figure 11-33 Hardware settings

The selected teach pendant mode must be same as what is used actually. Otherwise, it will trigger an alarm. If the user selects "None" and a teach pendant is connected, the alarm E9S3 will be sent out. The prompt that the current safety hardware config prohibits connecting to the teach pendant appears. Instead, it will trigger the alarm E9S1 and prompt that the teach pendant is disconnected.

11.2.9 Safety Parameters

The values of the safety parameters can be set in "Config > Safety". Safety parameters include: safety home, robot limits, joint position, joint speed, safety I/O, safety planes, and three position.

Click "safety check code" button, such as "38EB" in Figure 11-34 to display the safety parameter window for data viewing.

11 Configuration Tab

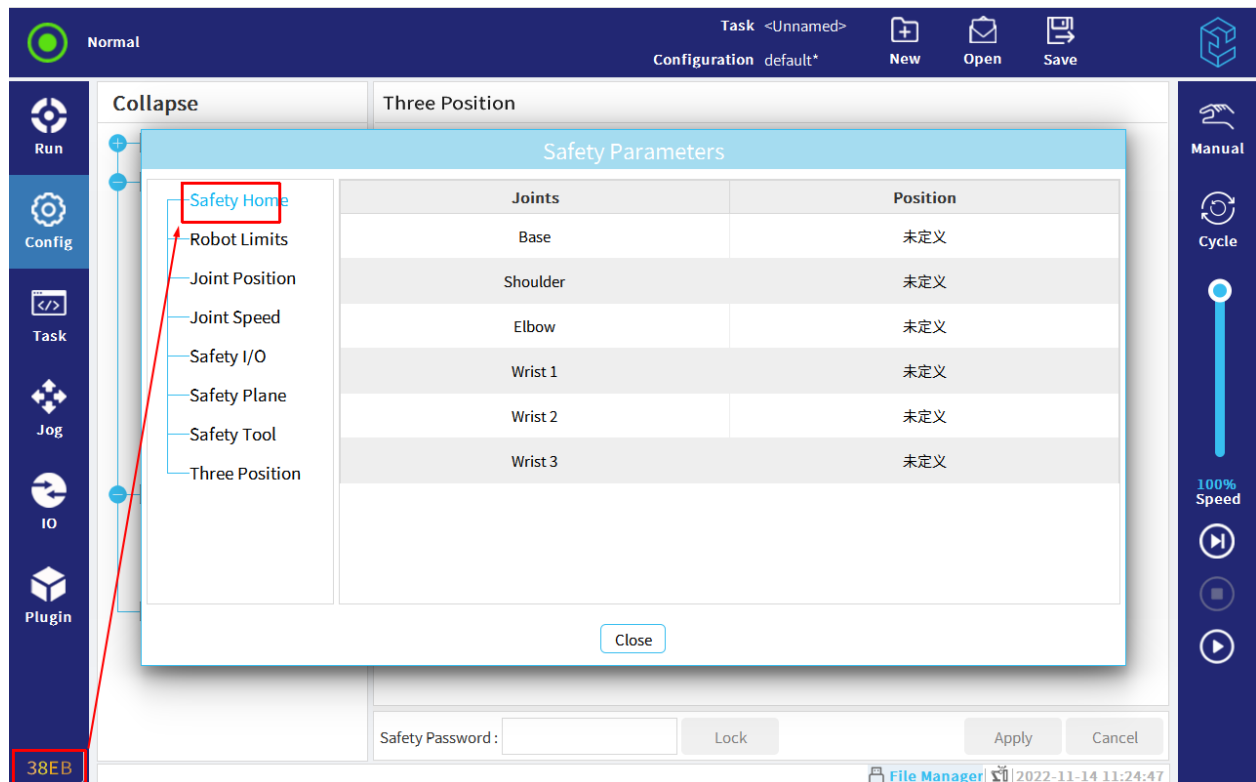

Figure 11-34 Safety parameters

11.3 Communication

11.3.1 Modbus

This section describes how to set the Modbus client IO signal.

1. Click "Config > Communication > Modbus" to enter the "MODBUS Client IO Setup" interface, as shown in Figure 11-35.

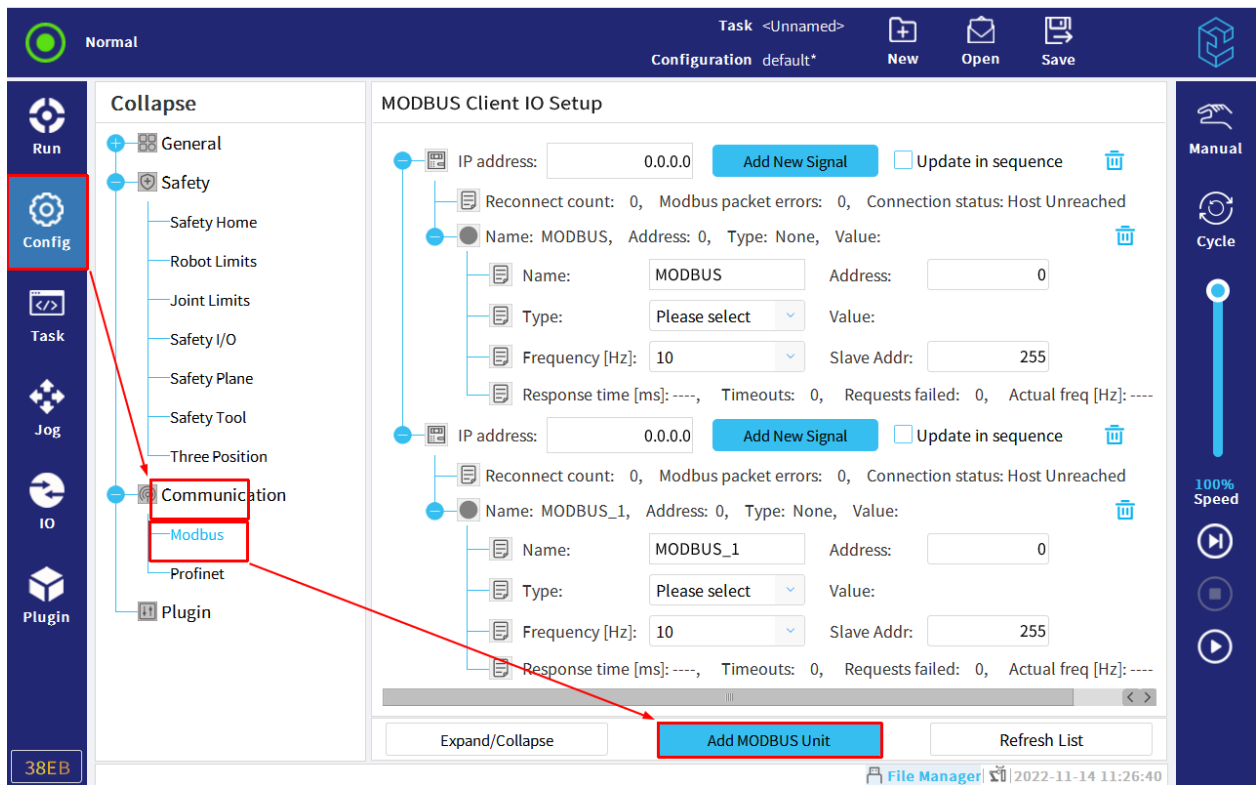

Figure 11-35 Modbus

2. Click "Add MODBUS Unit".
3. Set the "IP address", "Name", "Address", "Type" of the device and so on.
4. Click "Add New Signal" to set a new value to return to "Type".
5. Repeat steps 2-4 to continue adding.

The "Expand/Collapse" button at the bottom of the page can expand or collapse all nodes with one click. "Refresh List" allows the client to obtain the information of the server immediately, and does not follow the limit of refresh frequency

When the Modbus device is added, the corresponding IP address can be seen in "IO > Modbus" and the status information can be viewed conveniently.

11.3.2 Profinet

Click "Config > Communication > Profinet" to enter the Profinet interface, as shown in Figure 11-36. The Profinet interface includes the Profinet status bar, notification bar, robot I/O module, and register module insertion status.

In Notice block at the top right, the LED indications are explained. The status of Robot IO module and Register Modules are not inserted, the running program will trigger the corresponding action. There are three states under each module: 0 (none), 1 (pause) and 2 (stop).

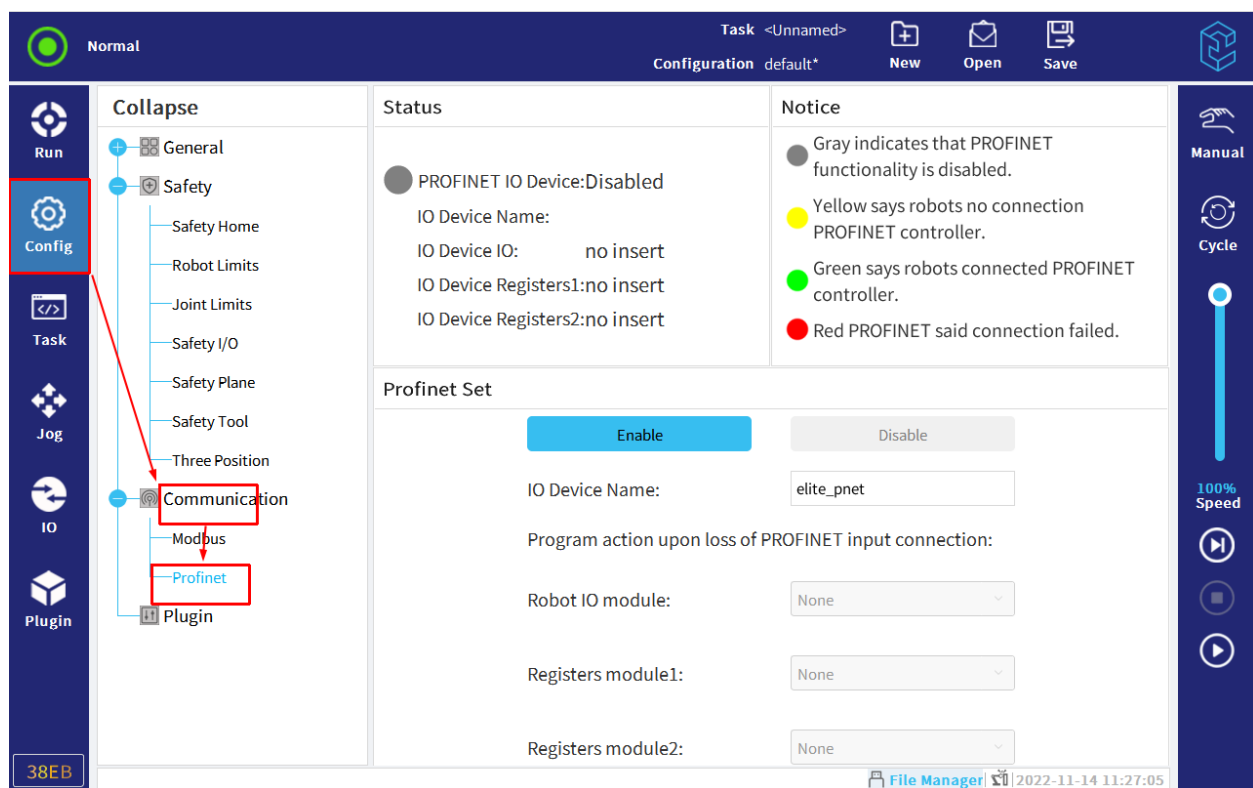

Figure 11-36 Profinet

11.3.3 Ethernet/IP

Click "Config > Communication > Ethernet/IP" to enter the Ethernet/IP interface, as shown in Figure 11-37. The Ethernet/IP interface includes the Ethernet/IP status bar, notification bar and the settings.

The status bar shows the current running status of the Ethernet/IP bus.

In Notice block at the top right, the LED indications are explained. Different colors mean different running status of the Ethernet/IP.

The settings are used to enable or disable the Ethernet/IP function. When the Ethernet/IP scanner is disconnected, the running program will trigger the corresponding action: None, Pause and Stop.

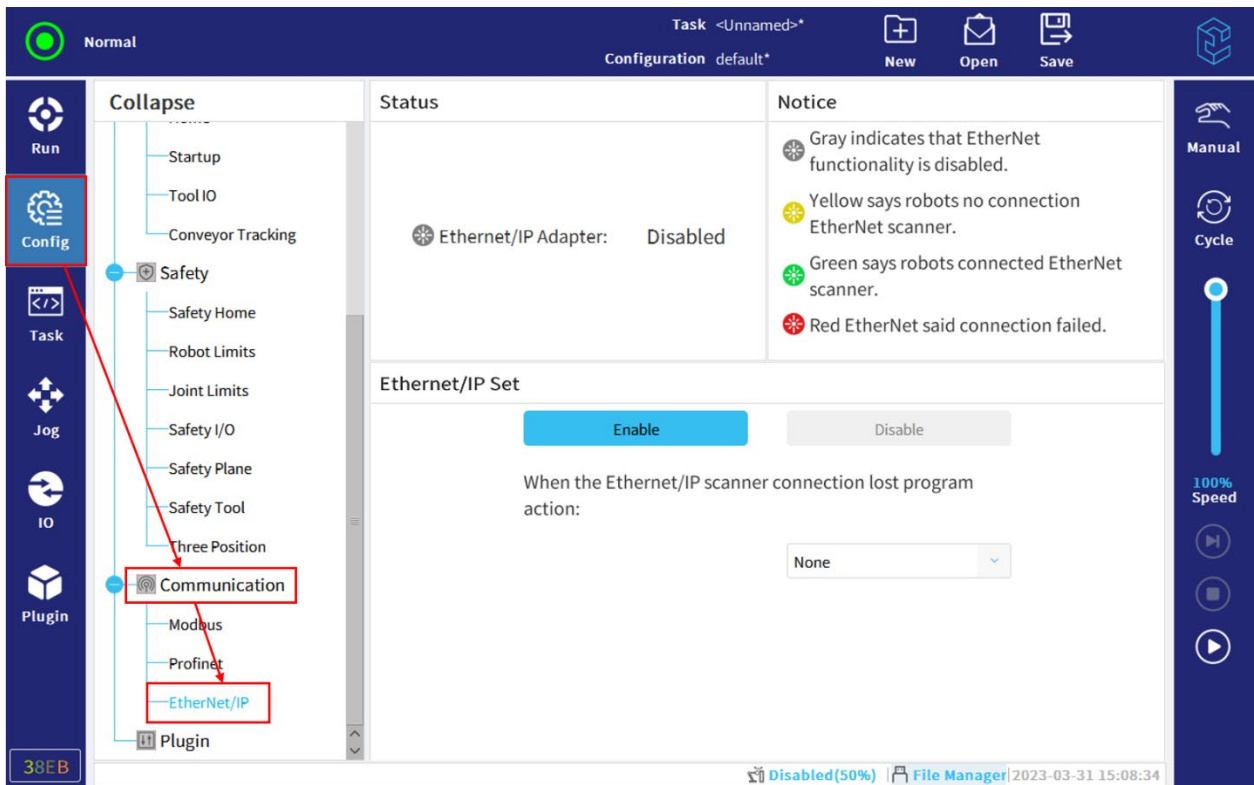

Figure 11-37 Ethernet/IP

11.4 Plugin

Plugin is used to display user-defined configuration plugin, as shown in Figure 11-38.

11 Configuration Tab

Figure 11-38 Plugin

12 Task Tab

This chapter mainly describes the options and operation instructions in CS620 robot task setting, including Task Tree, Instruction, Monitor, Basic Task Point, Advanced Task Point, Plugin and other options. In the basic task point, the users can perform basic level operations like Move, Waypoint, Direction, Wait. In the advance task point, users can perform operations like task loop, setting subtasks, assignment, etc.; In the plugin option, users can perform palletizing, conveyor belt and other more specific operations.

The tasks tab displays the tasks that are currently being edited, as shown in Figure12-1.

The examples of task nodes in this manual are for reference only. Please edit tasks according to actual needs.

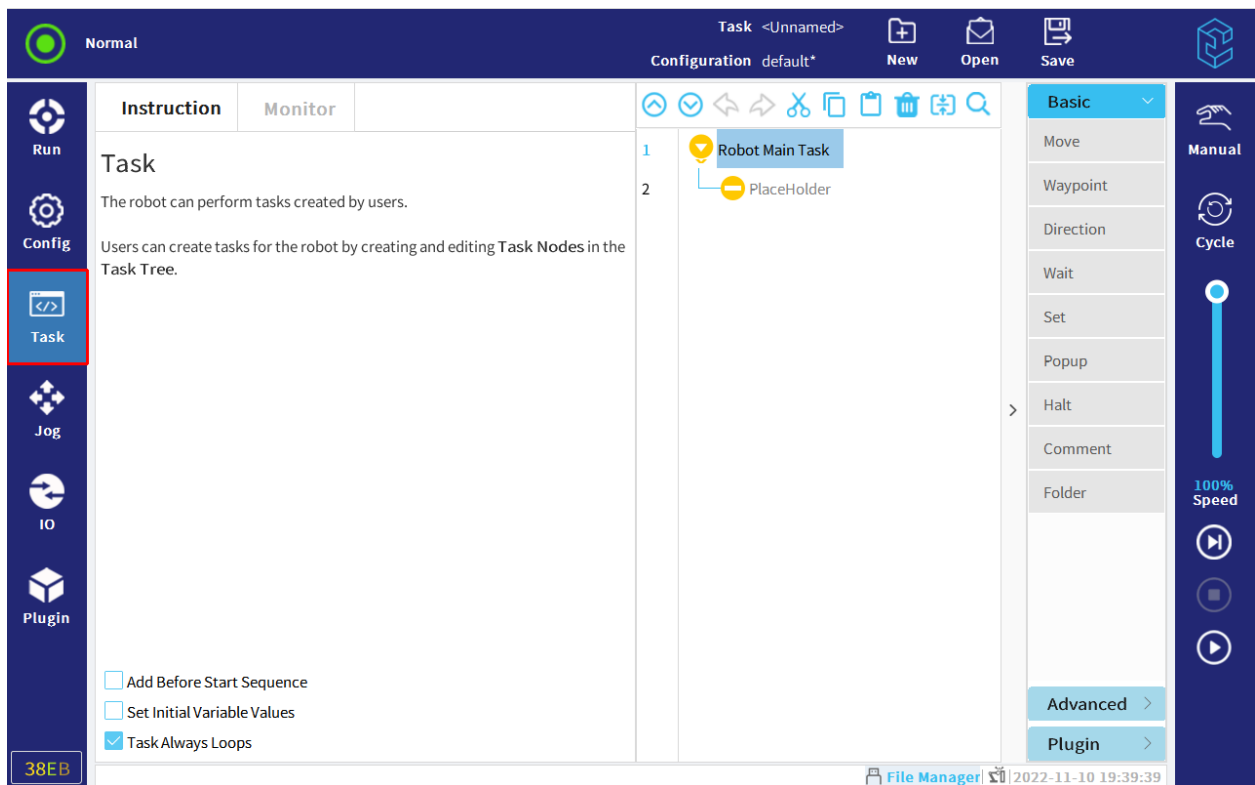

Figure 12-1 Task tab

12.1 Task Tree

The user can add a task node in the task tree, and select the required task node in the command bar on the right side of the page, as shown in Figure12-2.

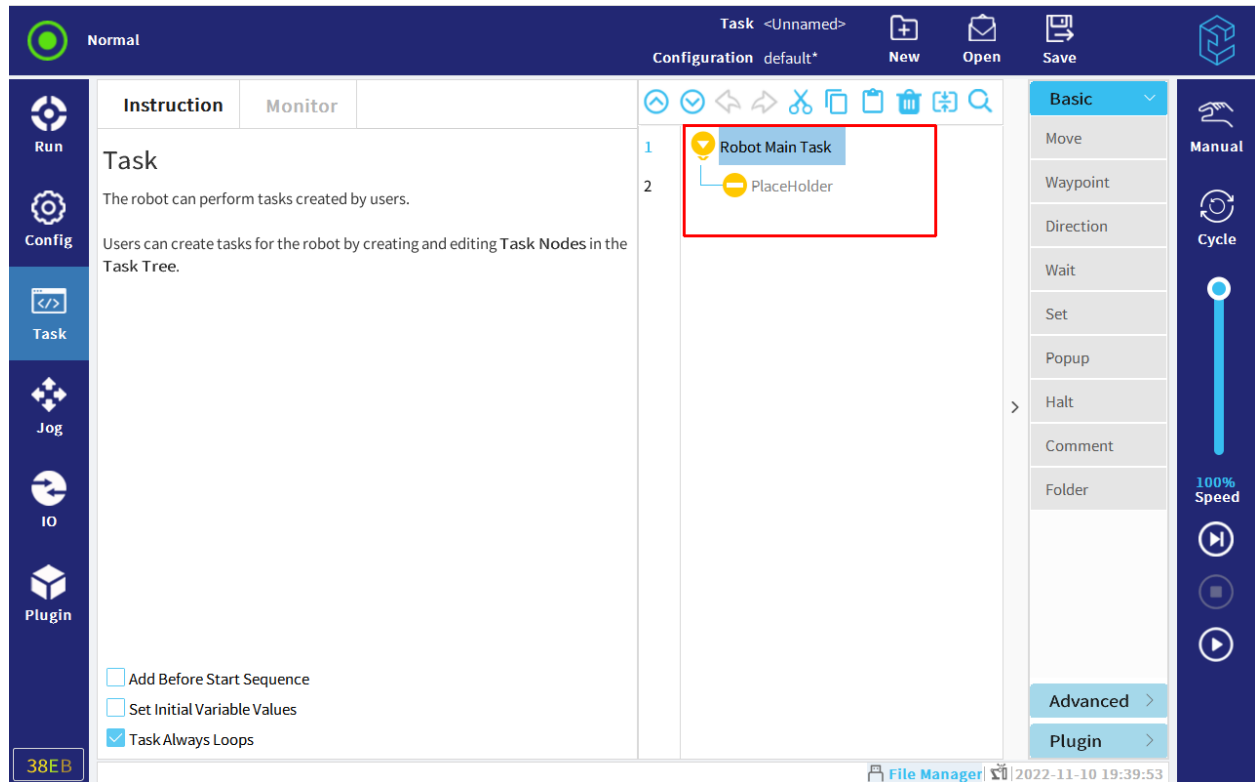

Figure12-2 Task tree

The user cannot run a blank task tree or a task tree contains an incorrect task node.

If the task node is not defined, the node will display an orange icon.

If there is search content in the task node, the task node will be highlighted in yellow.

If there is an error when the task is running, an exception message will pop up.

The exception information prompt box displays the error information of the task node, including the error type, current error code lines, etc., and supports the following operations:

1. OK: if there is only one error message, click "OK" to clear the abnormal message and alarm; If there are multiple error messages, click "OK" and the next error message will be displayed on the page.

2. Close all: clear all abnormal information and alarms.











3. Go to task view: clear all abnormal information and alarms, jump to the "Task" tab, and display the currently running task. The wrong node in the task tree is marked in red.

Note: In case of non UI operation, the exception information prompt box only displays the error description.

In the task tree, a blue arrow to the right  indicates the button which tracks the running status of the current task. Click the blue arrow and it will be hidden. If the user expects not to track the status, just click any task node in the task tree and the blue arrow will reappear on the display.

12.1.1 Task Tree Toolbar

The user can modify the task tree using the toolbar at the top of the task tree.

- Search: Click , enter the search content in the search box and click "Enter" to complete the search;
- Undo / restore: Click  and , undo and redo modified commands;
- Move up / down: Click  and , change the node position up and down. Moving nodes only support the position exchange of peer nodes;
Note: If node moves, its paired else if and else nodes move together.
- Cut: Click , cut a node and allow it to be used for other operations;
- Copy: Click , copy a node and allow it to be used for other operations;
- Paste: Click , paste copied or cut nodes;
- Delete: Click , delete node from task tree;
- Compress: Click , compress the nodes in the task tree. After compression, all relevant nodes will be skipped.

12.1.2 Expression Editor

The user can use the expression editor to edit text and expressions, as shown in Figure12-3.

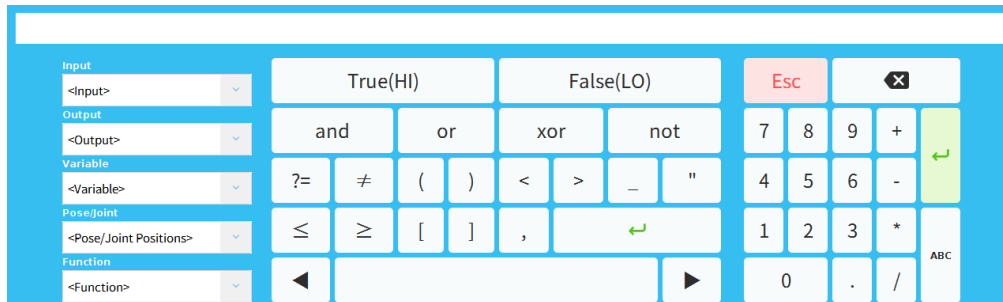

Figure 12-3 Expression editor

The expression editor provides input and output names, variable, pose/joint positions and functions, and can also insert special symbols in the expression, such as whether it is equal to "?" = " symbol.

All defined variables can be selected in the "Variable" drop-down box, and the available input and output ports can be selected in the "Input" and "Output" drop-down boxes. Special functions can be selected from the "Function" drop-down box. The user can also cite the coordinates, tool, waypoint pose, joint coordinates and other data from the drop-down list of "Pose/Joint Positions". Please note that what cited here are the the pose/joint data of somewhere the waypoint can reach (The attainable pose/joint data is subject to the contextual settings).

Use the "ABC" button in the lower right corner of the screen to switch to text editing mode.

Click , the system will save the expression. Click  to leave this screen and discard all changes.

12.2 Instruction Tab

The robot task node includes three check boxes that control the overall behavior of the task, as shown in Figure 12-4.

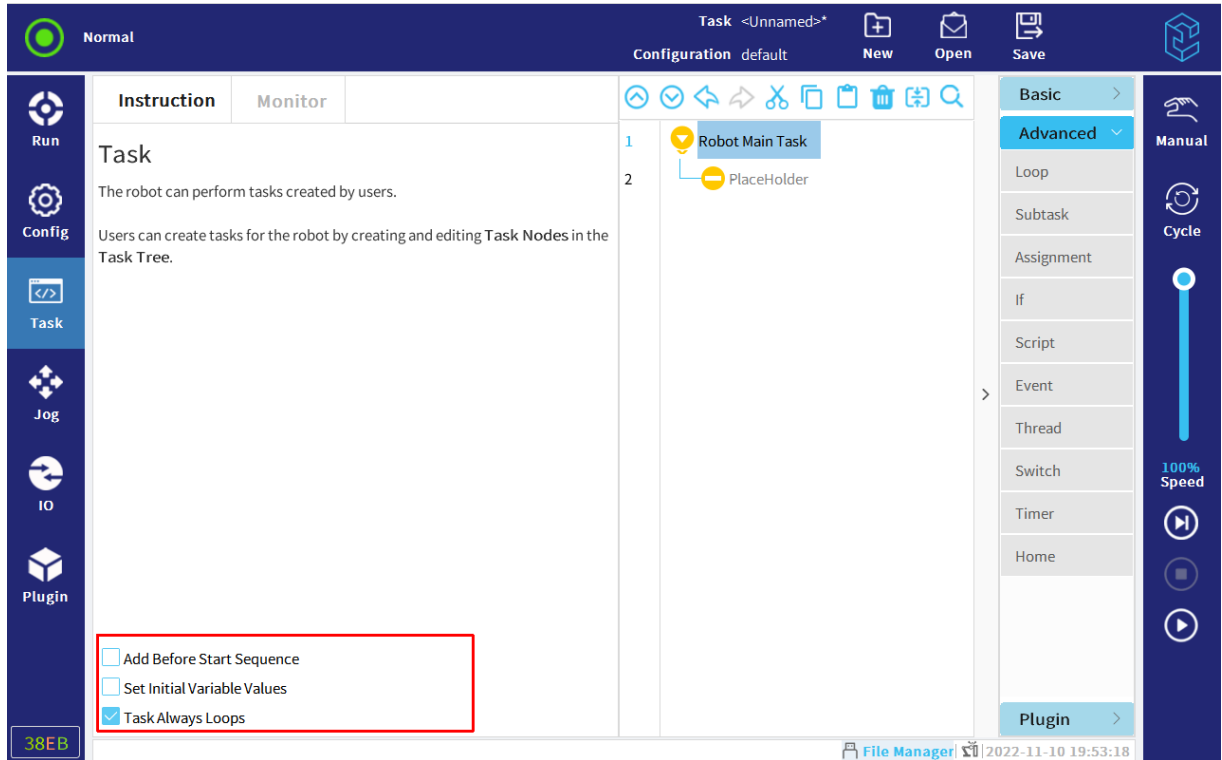



Figure 12-4 Instruction interface

- Add Before Start Sequence

Check or uncheck the check box to add or delete the "BeforeStart" node before the main task. The node under "BeforeStart" will be executed earlier than the robot's main task and will only be executed once. The single or cyclic operation of the robot refers to the single or cyclic operation of the main task of the robot.

Note: A "BeforeStart" node can only be added by checking this box. "BeforeStart" node can be removed by unchecking the "Add Before Start Sequence" or clicking  in the task tree.

- Set Initial Variable Values

Check this box to add an initialization variable node.

The initialization variable node collects the task variables created and used in the task, and supports renaming and initialization of these task variables and so on.

At the same time, if "Keep Value From Previous Run" is checked in the lower left corner, the variable can keep the running value. Run the task again without shutting

12 Task Tab

down, clearing the variable value or deleting the initialization node, and the variable will keep the last value.

1. The user can select a variable from the "Variable" drop-down list or from Initial Variable Values selector box, as shown in Figure 12-5.

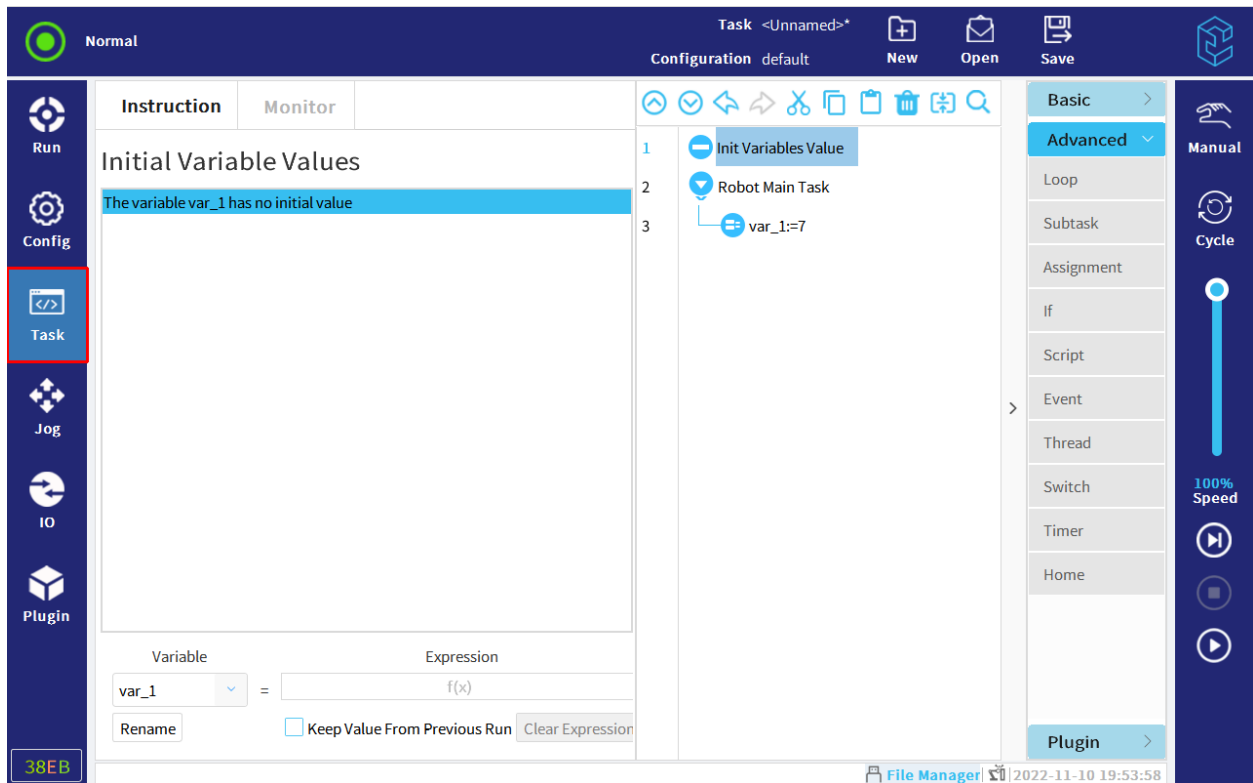

Figure 12-5 Select initial variable interface

2. Enter an expression for the variable. This expression is used to declare and initialize the variable value when the task starts.

Note: The variables created by the assignment instruction are local variables. The function of initializing variables is only applicable to local variables, not global variables.

- Task Always Loops

Check this box to keep the main task running over and over again.

12.3 Monitor Tab

The monitor tab monitors variables and robot views.

Besides, when the task is running, the variables tab displays the real-time variable values. When stopping, if the data is not cleared, the variable value at the moment when the task stops will be maintained.

If "Show Waypoint" is checked, the pose information of waypoints in the current task will be displayed in waypoints, as shown in Figure 12-6.

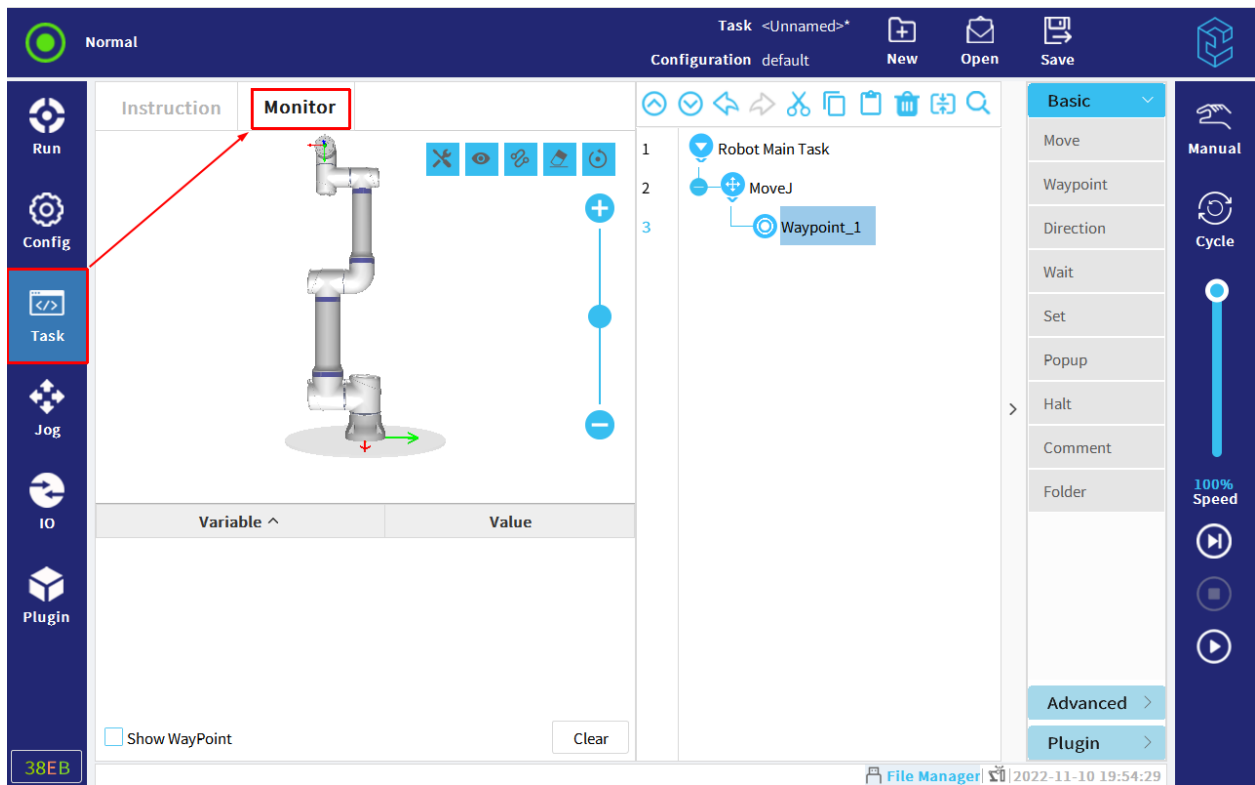

Figure 12-6 Monitor interface

12.4 Basic Task Node

12.4.1 Move

The movement command controls the movement of the robot through the basic waypoint. Waypoints must be placed under the motion command. The move command defines the type of movement of the robot between waypoints.

12.4.1.1 Movement Type

The user can select from the following three movement types: MoveJ, MoveL and MoveP, operation steps are shown in Figure 12-7.

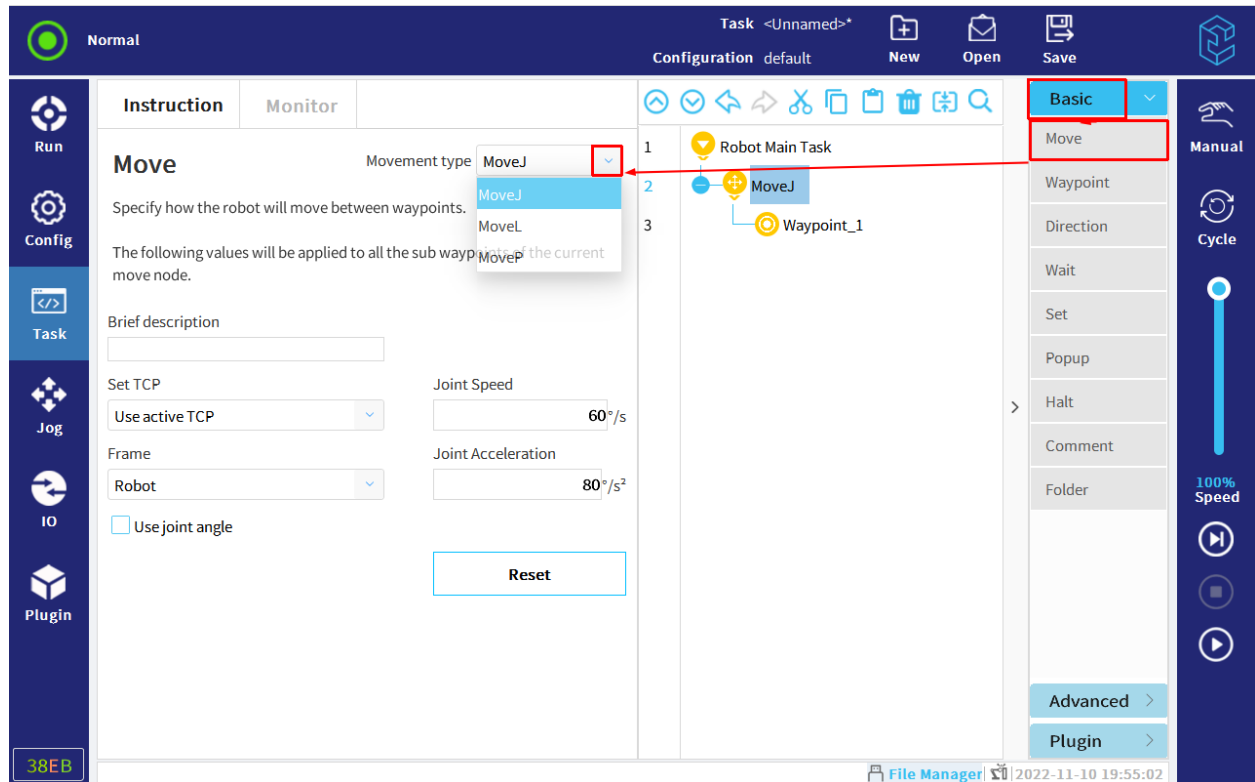

Figure 12-7 Select movement type

- **MoveJ:** Joint movement. Move in the space of the robot arm;

Control the joints to complete the movement of the robot. This movement type provides a curve path for the tool. The common parameters of MoveJ are joint velocity ($^{\circ}/s$) and joint acceleration ($^{\circ}/s^2$). If the operation needs the robot to move fast between waypoint, regardless of the movement track of the tool between these waypoints, MoveJ is the option to choose.

"Waypoint" node can be added under MoveJ node. For details, see section 12.4.2.

- **MoveL:** Linear movement. Make the tool center point (TCP) move in a straight line between waypoints;

The common parameters of MoveL are tool speed, tool acceleration and frame. The first two units are expressed in mm/s or mm/s².

"Waypoint" node can be added under MoveL node. For details, see subsection 12.4.2; "Direction" node can also be added, see section 12.4.3 for details.

- MoveP: Craft movement. Make TCP move in an arc at a constant speed.

By default, all waypoints under MoveP node use the transition radius of 25mm. The smaller the transfer radius value is, the larger the path angle is. On the contrary, the larger the value is, the smaller the path angle is.

"Waypoint" node can be added under the MoveP node. Please read section 12.4.2 for details. "Direction" node can also be added. Please read section 12.4.3 for details. The circular motion can be added to the MoveP node to make the robot do an arc motion. The arc path is calculated by a starting point (the current point), a passing point (ViaPoint) and an ending point (EndPoint).

Add arc motion:

1. Click "Task > Basic > Move" to add a move node.
2. Select movement type as "MoveP".
3. Click  , add an arc motion, as shown in Figure 12-8.

12 Task Tab

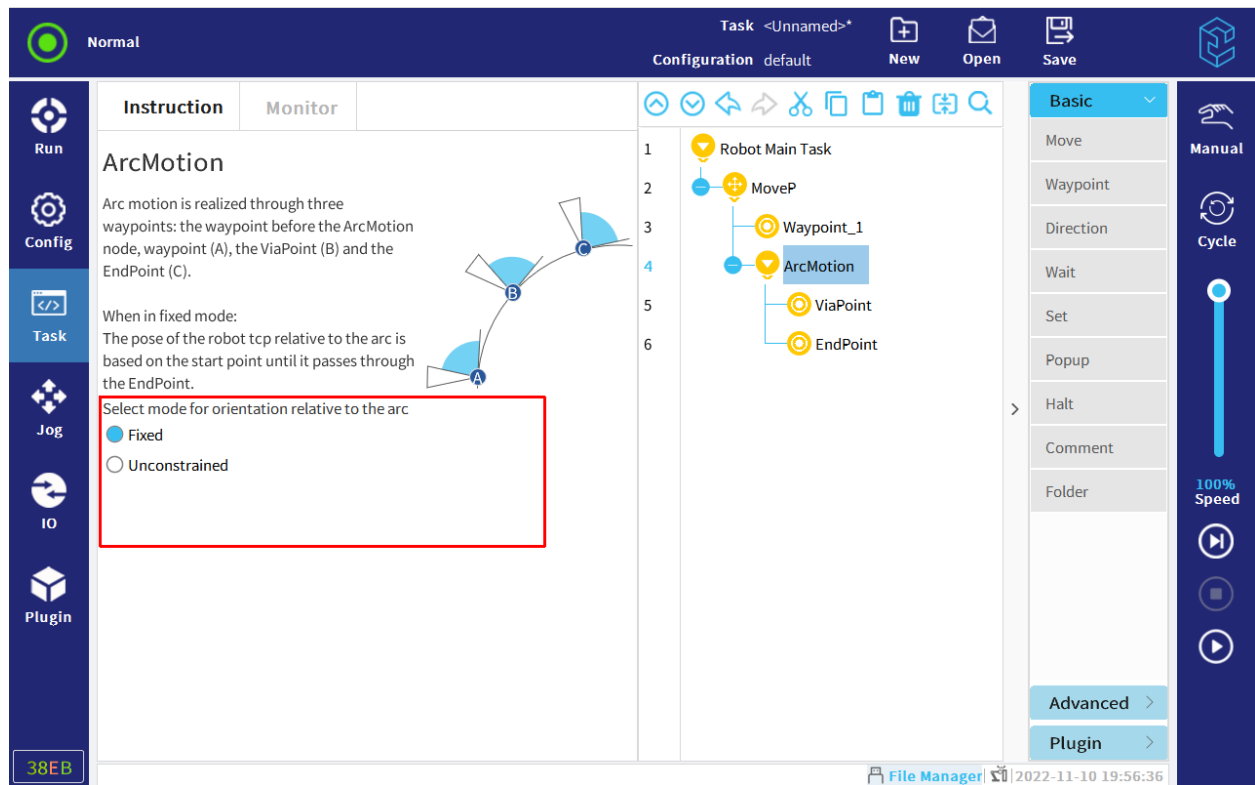

Figure 12-8 Circular motion

4. Select the mode of circular motion: fixed or unconstrained.

- Fixed: when the robot passes through points A, B and C, the tangent angle between the robot pose and the corresponding point shall be consistent;
- Unconstrained: when the robot passes through points A, B and C, the tangent angle between the robot pose and the corresponding point shall be subject to the actual needs, which is not consistent.

5. Set "Via Point" and "End Point", see section 12.4.2 for details.

12.4.1.2 Set TCP

After setting, TCP is used to mark the tool attitude data when setting the attitude of the waypoint. After switching TCP or changing TCP, the end tool can still reach the target pose.

There are three drop-down menu options:

- Ignore active TCP: Regardless of the existence of the tool, when the robot moves, the center point of the tool flange reaches the target pose;
- Use active TCP: use TCP as the currently activated TCP in "Config > General > TCP". As long as the robot runs, use the currently active TCP to do relevant calculations;
- Customized TCP: the user can select the customized TCP in "Config > General > TCP". Whether activated or not, the selected TCP will be used for relevant calculations.

12.4.1.3 Frame

After setting the frame, the selected frame will become the reference frame of the robot.

Selected frame will affect the actual operation effect of sub nodes such as "Waypoint" or "Direction". For details, please refer to subsections 12.4.2 and 12.4.3. If the frame changes, it will affect the actual target pose of the robot.

- Base: the base frame is used as the reference frame for robot motion;
- Custom frame: use the custom frame in "Config > General > Frame" as the reference frame.

12.4.1.4 Use Joint Angle

This function is only available when the joint type is "MoveJ". After "Use joint angle" is checked, the "Tool" and "Frame" options will be disabled, and the waypoints under this joint type will inherit the parameter "Use joint angle" when running.

Note: If checked, when the waypoint under this motion type moves, the pose will no longer be considered, but the joint angle at the time of recording will be taken as the motion target.

12.4.1.5 Reset

The user can restore all parameters modified by the current joint to the default values.

12.4.2 Waypoint

The waypoints are the core element of the robot task, since they are used to record the target points on the path for the robot to reach. The Waypoint can be insert as shown in Figure 12-9.

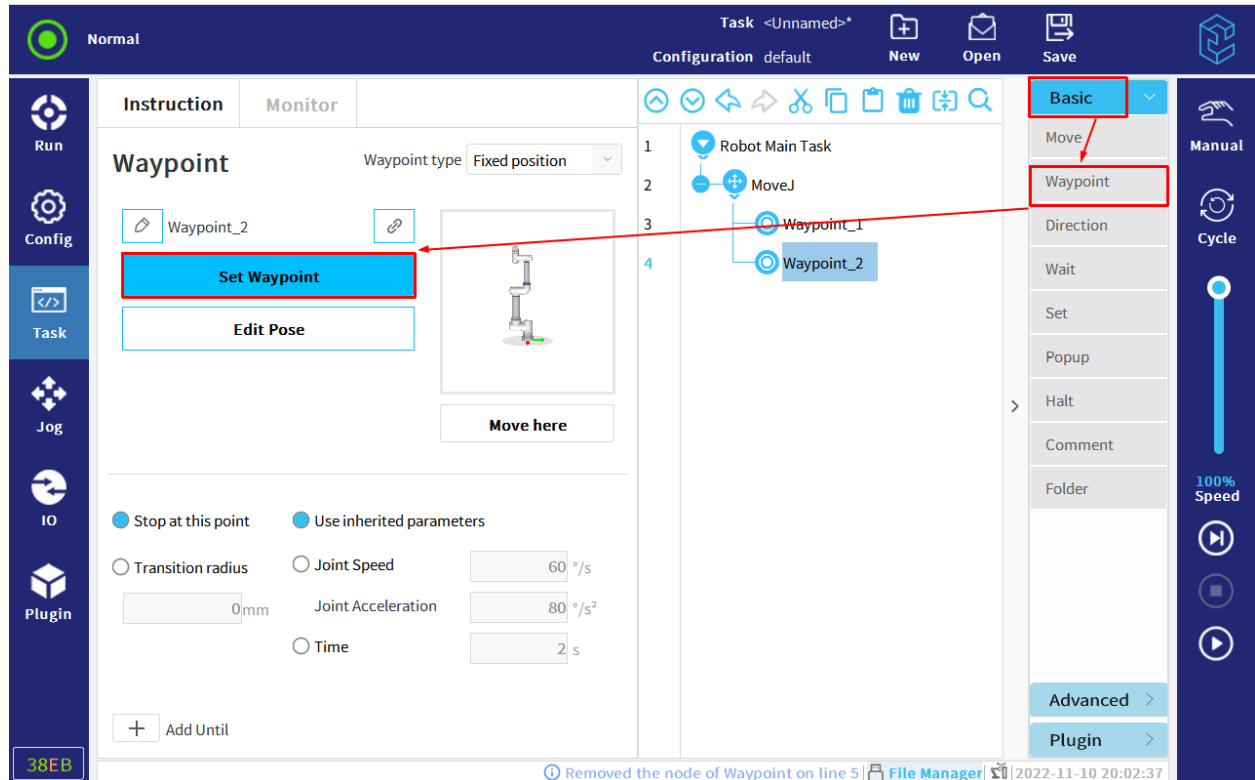

Figure 12-9 Waypoint

12.4.2.1 Waypoint Type

There are three types of waypoints: fixed position, relative position and variable position.

- Fixed position waypoint: after teaching, the robot arm moves with the taught point position data;
- Relative position waypoint: after teaching two waypoints and calculating the pose difference between the two waypoints, the robot will use the current pose plus the calculated pose difference to move;
- Variable position waypoint: variable waypoint refers to the location of the waypoint given by the variable. For the variable waypoint in the MoveJ instruction, it will run

as the joint position. For the variable waypoint in the MoveL and MoveP instructions, it will run as the pose. Therefore, please make sure that the variable data matches the motion type. Otherwise, the unexpected problems may occur in the movement.

12.4.2.2 Rename

The Renaming button as shown in Figure 12-10 allows the user to rename waypoint_1, etc. to something else.

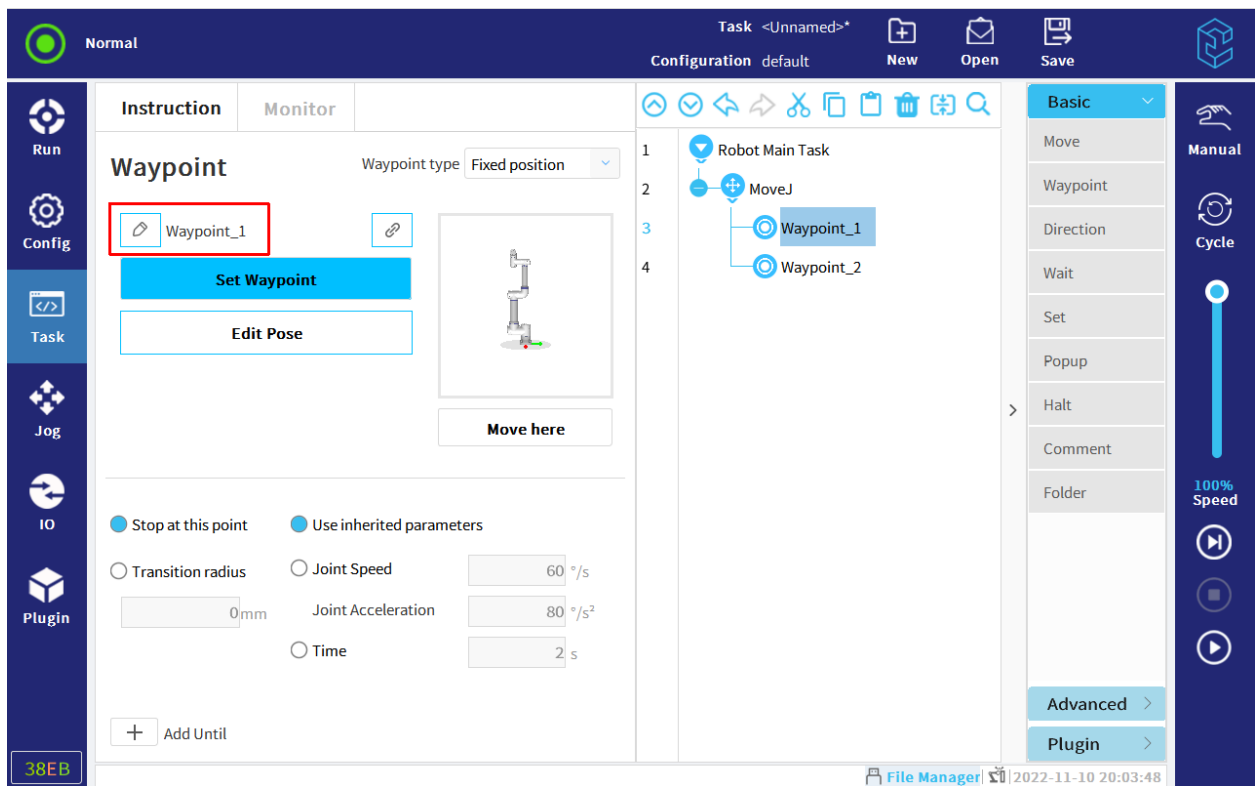

Figure 12-10 Rename

12.4.2.3 Teach Waypoint

The user can teach the fixed position waypoint through "Set Waypoint" or "Edit Pose"; the relative position for a waypoint can be taught by "Set Point". Please read Chapter 14 for details.

12.4.2.4 Transition Radius

If the transition radius is set, the robot will transition to next waypoint before reaching the current waypoint. The transition radius cannot overlap. Therefore, when setting the transfer radius of a waypoint, it cannot overlap with the transfer radius of the previous waypoint or the next waypoint.

There are three modes of transition radius:

- **Stop (no transition radius):** When the motion type is "MoveJ" or "MoveL", the waypoint parameter can be set to "Stop at this point". After setting, when the robot passes through the waypoint, it will stop first and then move to the next waypoint;
- **Custom:** for waypoint under all joints, the user can customize the transition radius;
- **Inheritance:** when the joint type is "MoveP", the waypoint parameter can be set to "Use inherited transition radius". In this case, the transition radius of the waypoint will be same as the configuration under the "MoveP" node.

12.4.2.5 Add Until

Under the "Waypoint" node, click  to add the "Until" node. Multiple stop conditions can be added. The "Until" node sets the stop condition for the motion. When the stop condition is reached, the robot stops moving.

In the task tree, the user can add the "Until" node under the "Waypoint" node or the "direction" node.

The user can add multiple stop condition for single movement.

When the stop condition of the first "Until" is met, the robot stops moving.

Click the "Until" node, and the user can set the following stop conditions:

- **Expression:** Custom task expression. The user can use IO, variables, pose or script functions to specify the stop condition;

If "Use Inherited Deceleration" is checked, the deceleration of the waypoint will be same as the configuration under the waypoint node.

If "Use Custom Deceleration" is checked, the robot will decelerate at the customized deceleration when the conditions are met.

- Waypoint reached: The robot runs to the waypoint;
- IO input: Control the robot to stop movement through digital input signal or analog input signal.

12.4.2.6 Add Action

After "Add Action" is enabled, under the "Until" node, the user can add other actions to be executed when the stop conditions are met. If this function is disabled, the defined actions under the "Until" node will be deleted.

12.4.2.7 Insert Waypoint

The operation steps of inserting waypoints are as follows:

1. Insert a "Move" node in the "Task" tab.
2. Click "Waypoint".
3. Select "MoveJ" node, set movement type.
4. Set "Waypoint type" and configure the parameters of waypoints.
5. After setting, the waypoint node is displayed in blue, as shown in Figure 12-9.

12.4.3 Direction

The task specifies that the robot moves in a specific direction. The robot moves linearly in the direction of the selected frame until it is stopped by the "Until" condition.

12.4.3.1 Add Directional Movement

1. Select "Task > Basic > Direction".
2. Under "Frame", define linear movement, as shown in Figure 12-11.

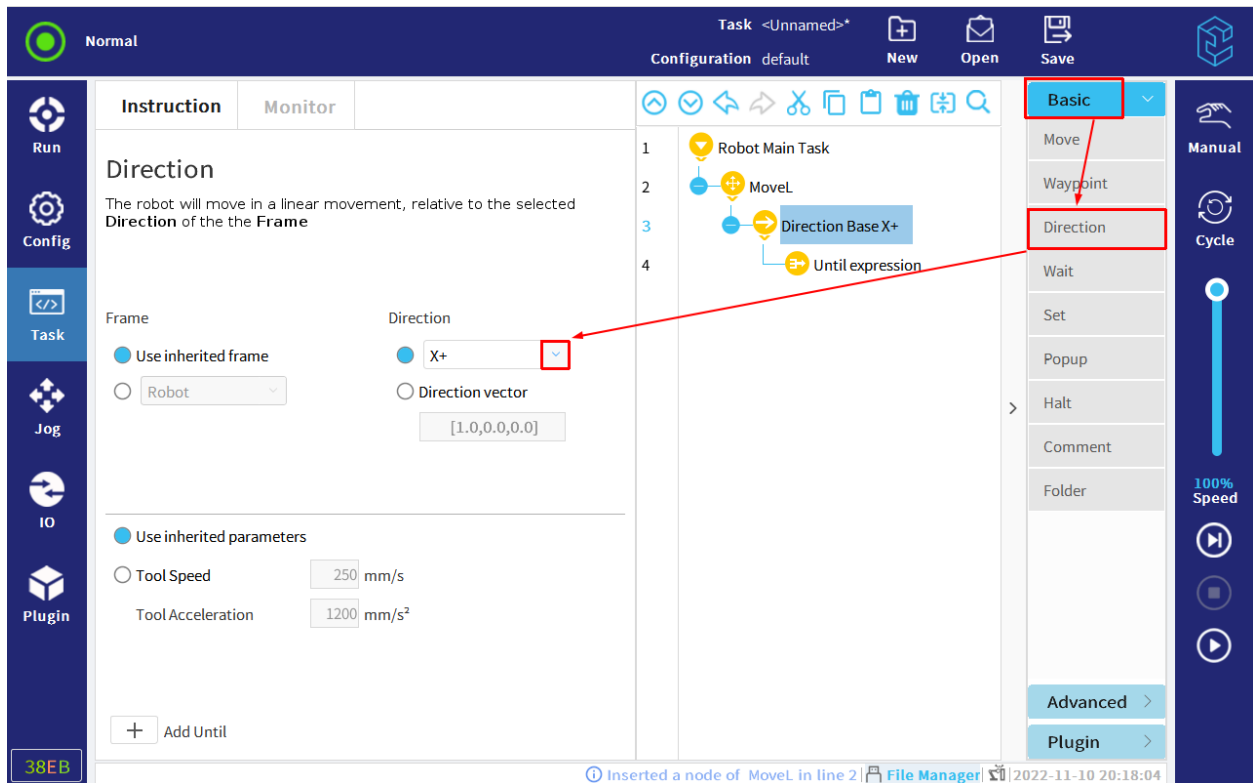

Figure 12-11 Add directional movement

12.4.3.2 Add Until

Under "Direction", an Until expression will be automatically generated. To add more Until, click "Add Until" button at the lower left corner, click "Until Expression" in the task tree to add stop conditions, as shown in Figure 12-12.

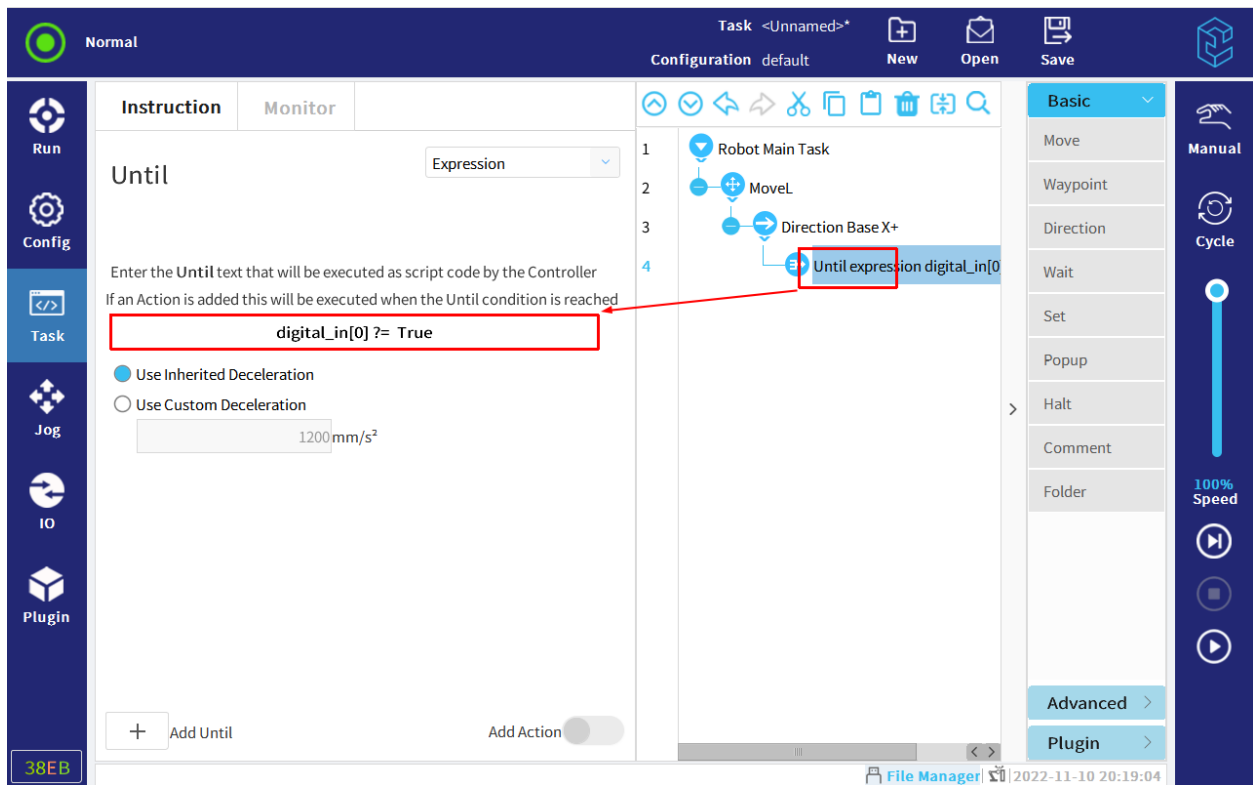

Figure 12-12 Stop directional movement

The stop conditions that can be defined are as follows:

- Distance:** The robot stops moving in the direction after moving a certain distance; If "Stop at this point" is checked, the robot moves the specified distance and the speed decreases to 0. If "Transition radius" is checked, when the robot is about to reach the specified distance, the speed will gradually decrease and move with arc transition.
- Expression:** Custom task expression. The user can use IO, variable, pose or script function to specify the stop condition. For details, see section 12.4.2.5;
- IO input:** Control the robot to stop movement through digital input signal or analog input signal. See section 12.4.2.5 for details.

12.4.4 Wait

The user can set the conditions to stop waiting in the "Wait" node. When the conditions are met, end the waiting and continue to run the task, as shown in Figure 12-13.

12 Task Tab

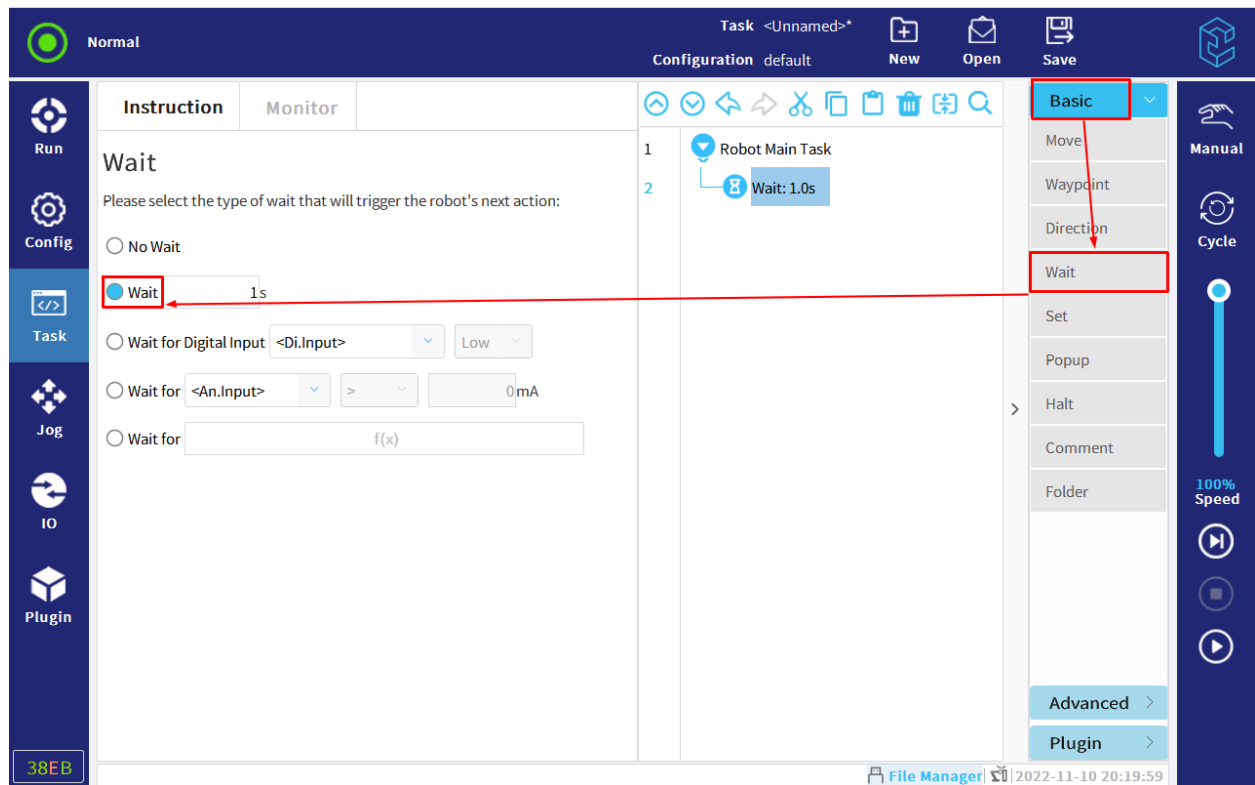

Figure 12-13 Wait

Wait condition including:

- No Wait;
- Specific Time;
- Digital Input Signal;
- Analog Input Signal;
- Expression.

Note: If the tool communication interface is enabled, the waiting condition cannot select the analog input signal AI [2].

12.4.5 Set

The user can set the trigger action in the "Set" node, as shown in Figure 12-14.

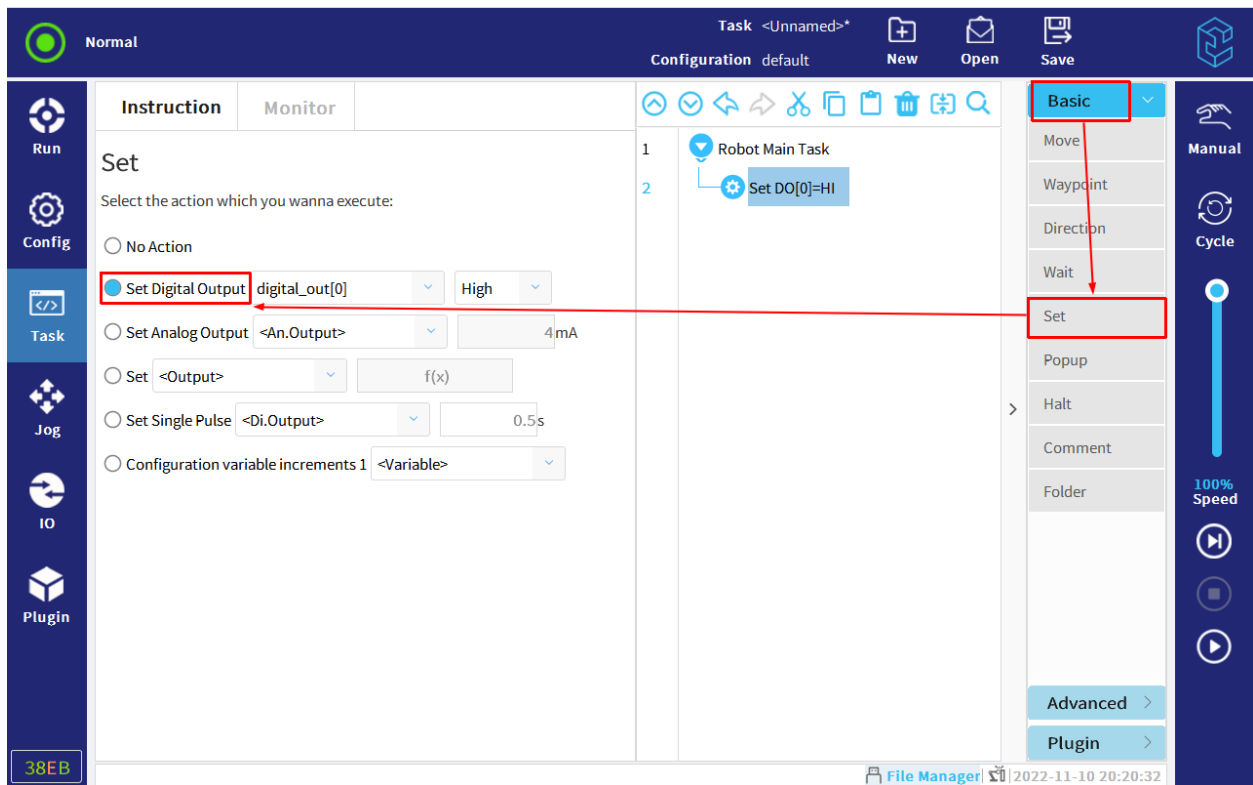

Figure 12-14 Set

Trigger actions include:

- No Action;
- Set the digital output signal, the value type is high or low (True or False);
- Set analog output signal: the value is current or voltage, depending on the type of analog output in the "IO" tab;
- Set general signals, including digital, analog, configurable, tools and Modbus output signals: the value is an expression;
- Set the single pulse of digital, configurable, tool and Modbus output signal, that is, first set the corresponding signal to high (True), and then set the corresponding signal to low (False) after a specified time;
- Set configuration variable increment 1: the selected configuration variable is incremented by 1.

12.4.6 Popup

The "Popup" node can set text or variables. When the task runs to this node, the message or text will be displayed on the screen, as shown in Figure 12-15.

12 Task Tab

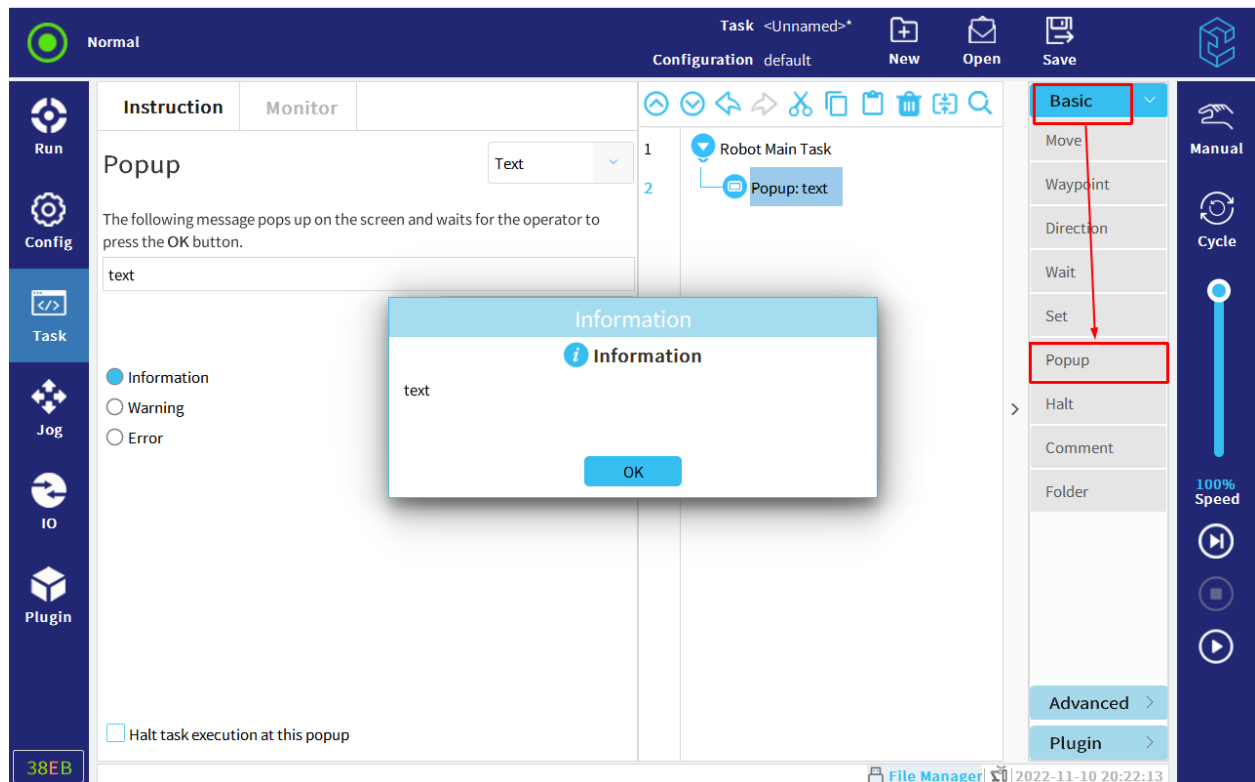

Figure 12-15 Popup

The user can select the type of pop-up message as information, warning or error.

There are two kinds of pop-up contents:

- **Text:** when running program reached the pop-up node, a text message entered by the user will pop up;

Click "Preview Popup" to preview the popup window information.

- **Variable:** if "variable" is selected, when running program reached the pop-up node, the current value of the variable will pop up.

After the pop-up window showing up, the robot will wait for the user to press the "OK" button in the window and continue to run the task. If "Stop Task" is pressed, the task stops running.

If "Halt task execution at this popup" is checked, the robot task will stop running when the message window pops up.

Note: The message can contain up to 255 characters.

12.4.7 Halt

The task will stop running at this point, as shown in Figure 12-16.

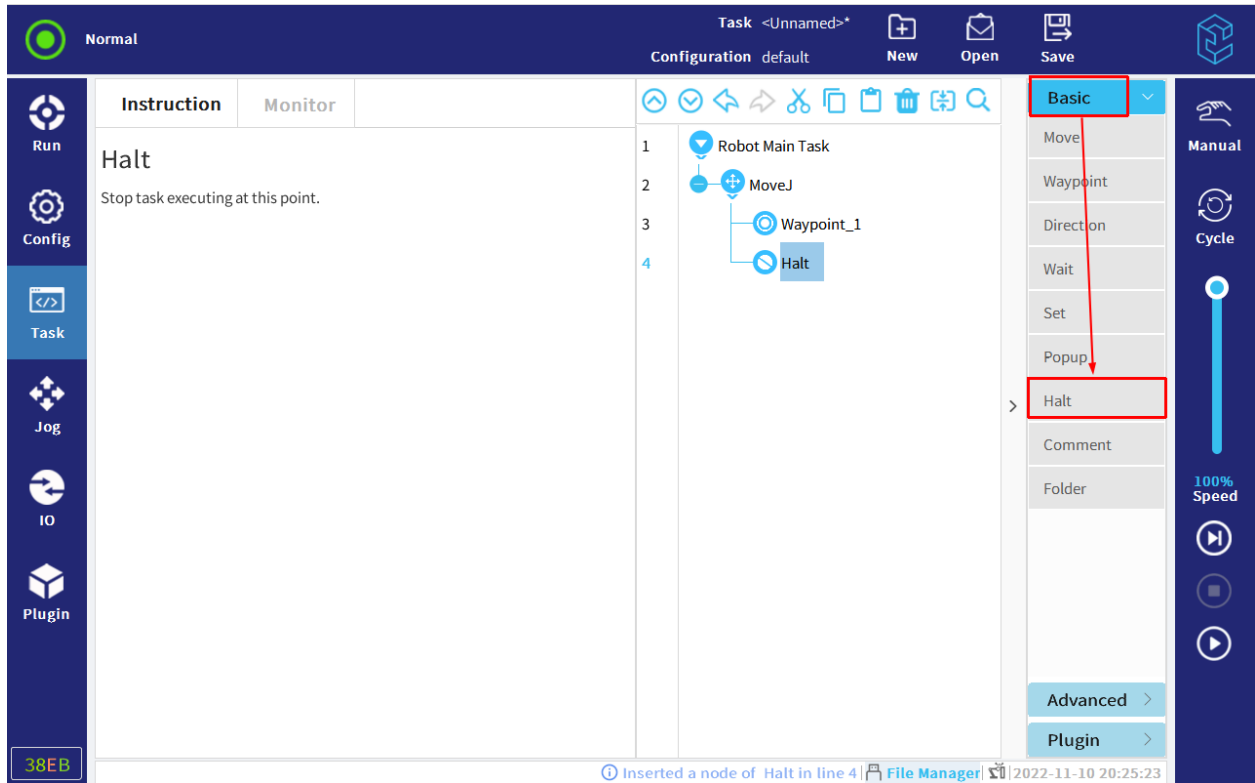

Figure 12-16 Halt

12.4.8 Comment

This command allows the user to add a line of text to the task to explain the task. When the task is running, this line of text will not perform any operation, as shown in Figure 12-17.

12 Task Tab

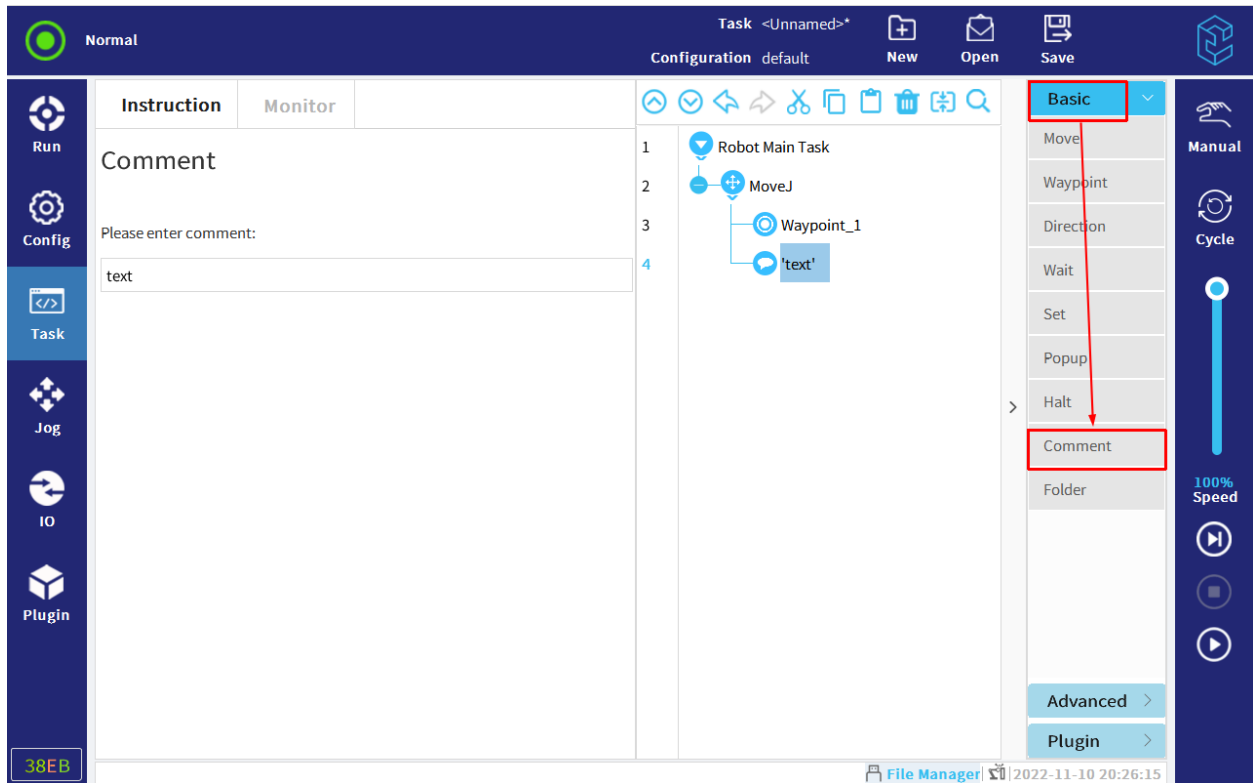

Figure 12-17 Comment

12.4.9 Folder

As shown in Figure 12-18, the folder command is used to organize tasks and label specific task parts, which will make the task tree easier for users to read and modify.

Folders have no effect on tasks execution.

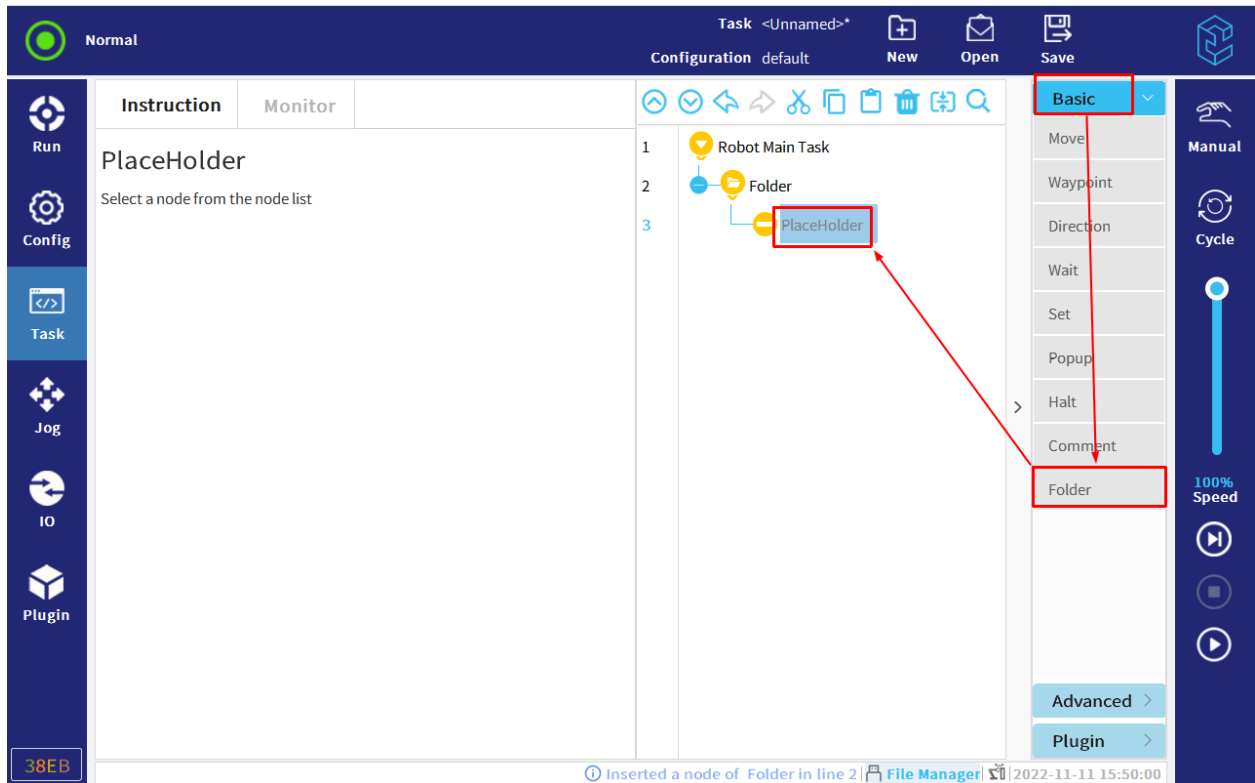

Figure 12-18 Folder

12.4.10 Set Payload

The "Set Payload" node allows the user to customize the payload by editing the Mass (unit: kg) and Center of Gravity (unit: mm). Click the "Set Now" button and the custom settings will take effect. The user can also click the drop-down list in the right of the "Custom Payload Config" to switch over to the payload previously set at the runtime, as shown in Figure 12-19.

12 Task Tab

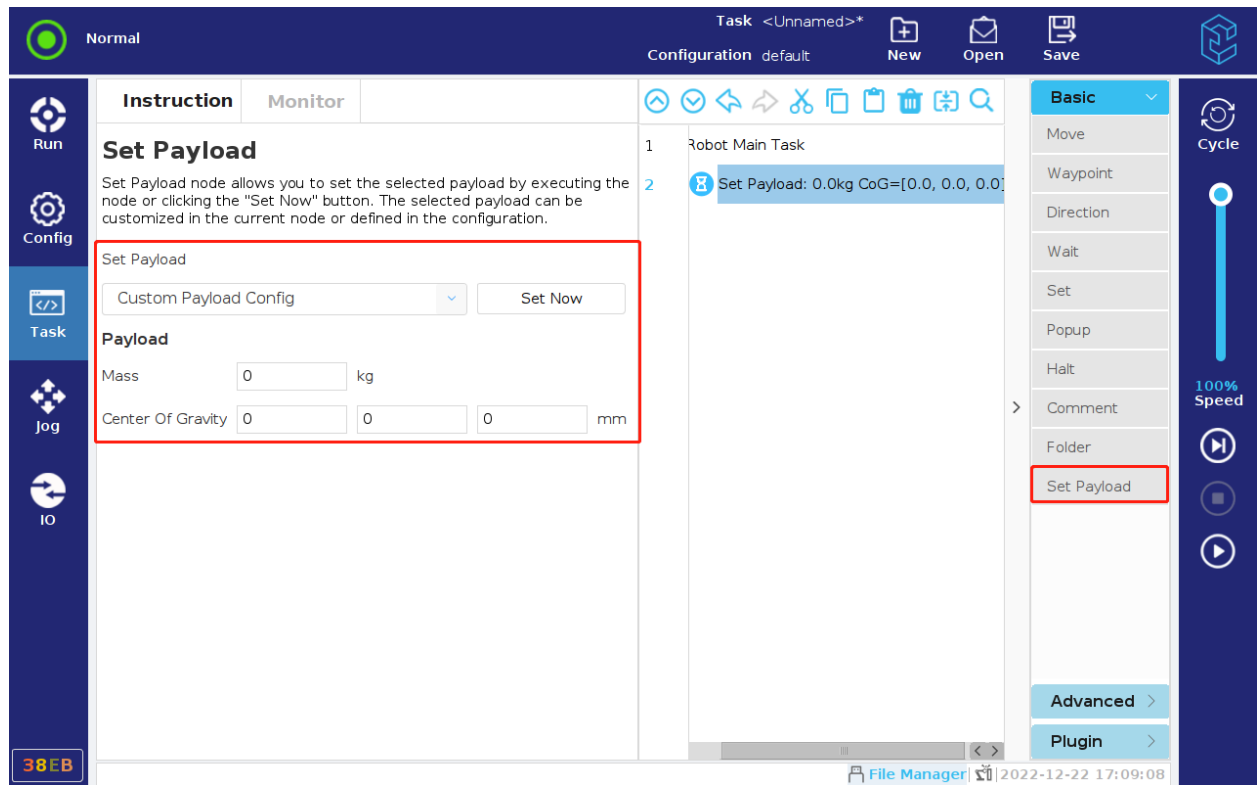

Figure 12-19 Set Payload

12.5 Advanced Task Node

12.5.1 Loop

The "Loop" node can configure the looping method of its child node tasks, as shown in Figure 12-20.

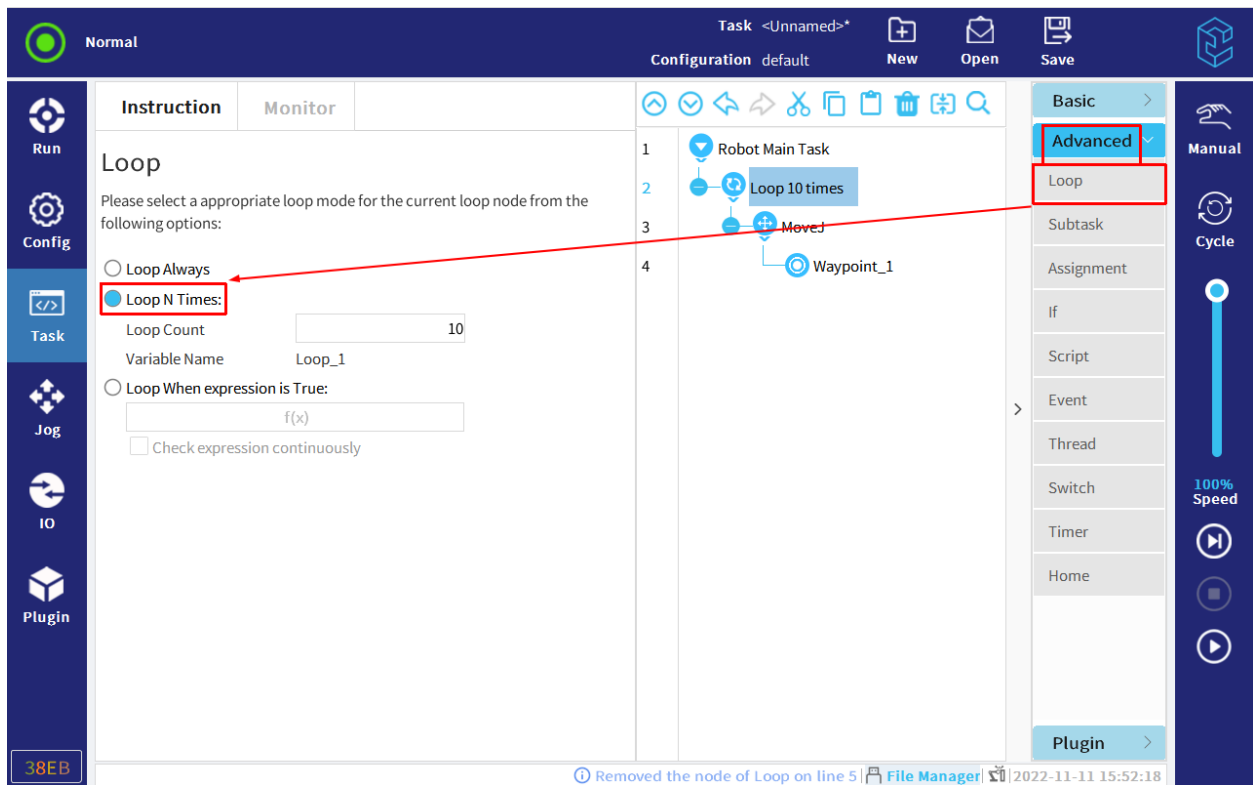

Figure 12-20 Loop

Loop mode including:

- Loop Always : The task loops all the time;
- Loop N Times: Defines the loop times;
When the specified number of loops is run, the task will create a special loop variable, which is used to count the number of loops.
- Loop When the expression is True: when the expression is true, the tasks of the child nodes will be executed in a loop all the time.
Note: If "Check expression continuously" is checked, during the loop, as long as the expression is not true, it will immediately jump out of the loop and execute down.

12.5.2 Subtask

Under the "Subtask" node, the subtask can be directly edited or loaded with existing task file. After subtask node is created, it can be called under the main task node.

12 Task Tab

When a subtask node loads a task file, only the nodes under the main task will be added to the subtask node.

REMINDER



1. The sub task nodes cannot exist in the loaded task file. If there are sub task nodes, the task file loading will fail. Then the system will notify the user to remove all the sub task nodes in the task file for loading. After the modifications are saved, the user can try to re-add the sub task.
 2. There can be multiple subtask nodes in the same task file, but the files loaded by the subtask nodes cannot be the same.
-

12.5.2.1 Create Subtasks

Create subtasks as follows:

- Select the "Robot Main Task" node or the subsequent peer node, and then click "Advanced > Subtask" to insert the subtask node;
- At any node in the main task, click "Advanced > Subtask" and select "New" under the "Call" node.

12.5.2.2 Edit Subtasks

The user can edit child nodes directly or load existing task files.

The operation steps of loading task file are as follows:

1. Click "Load File" and select the task file in the pop-up window.
2. Make the following edits:

Save subtask: save the modified subtask file.

Clear subtask: delete the loaded task file and delete the corresponding node under the subtask.

Note: "Clear Subtask" is valid only when the task file is loaded.

If "Keep Subtask File Update with this Task" is checked, the loaded subtask files will also be updated when the main task is saved.

REMINDER

"Keep Subtask File Update with this Task" is valid only when the task file is loaded.

If "Hide Subtask Tree" is checked, the nodes under subtasks will not be displayed.

12.5.2.3 Call Subtasks

In the task tree, users can call subtasks. The called subtask can be saved or directly created.

1. Under any node under the main task, select "Task > Advanced > Subtask".
2. Click "Call" in the task tree, click "New" or select an existing subtask file, as shown in Figure 12-21.

12 Task Tab

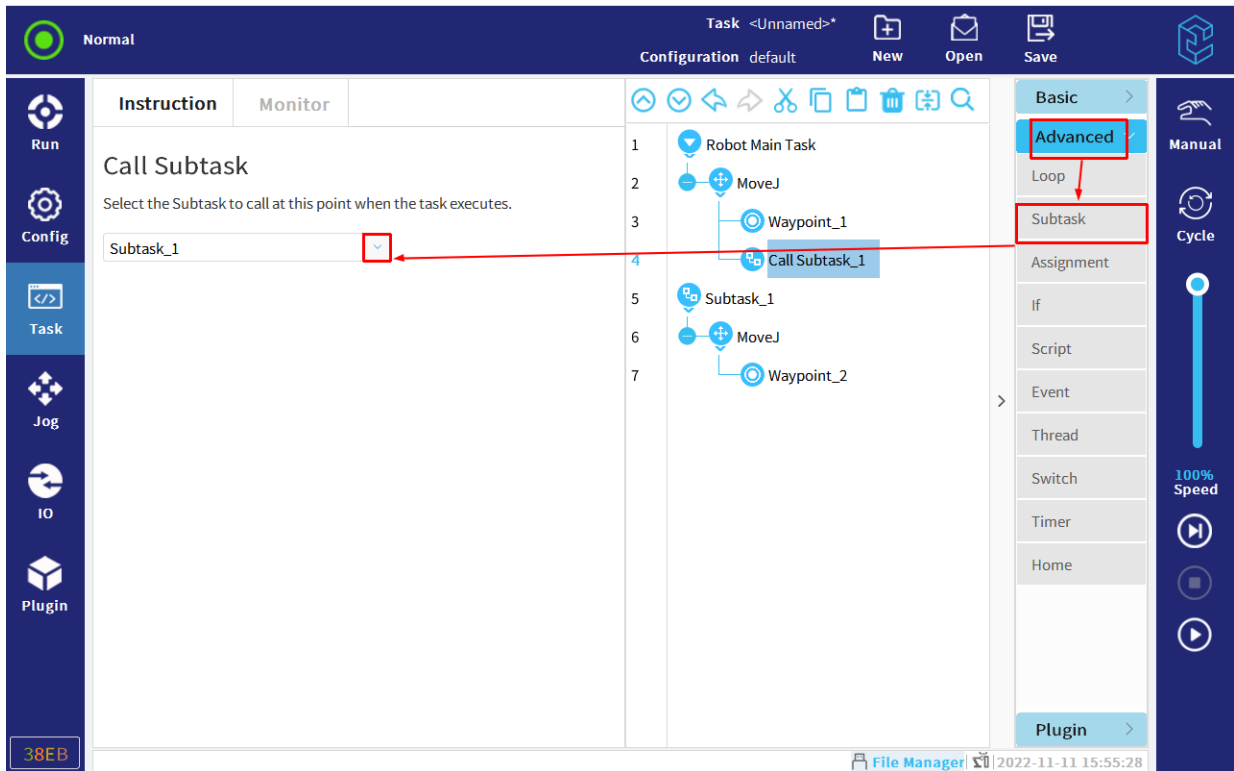

Figure 12-21 Call subtask

3. Click the subtask node to edit the subtask.

Upon executing the "Call" node, the controller will jump to the corresponding subtask node. After completing the subtask the robot will continue to run the main task.

12.5.3 Assignment

The process of assigning a value to a variable is called assignment. As shown in Figure 12-22. The variables created by the assignment instruction are local variables, which can be initialized.

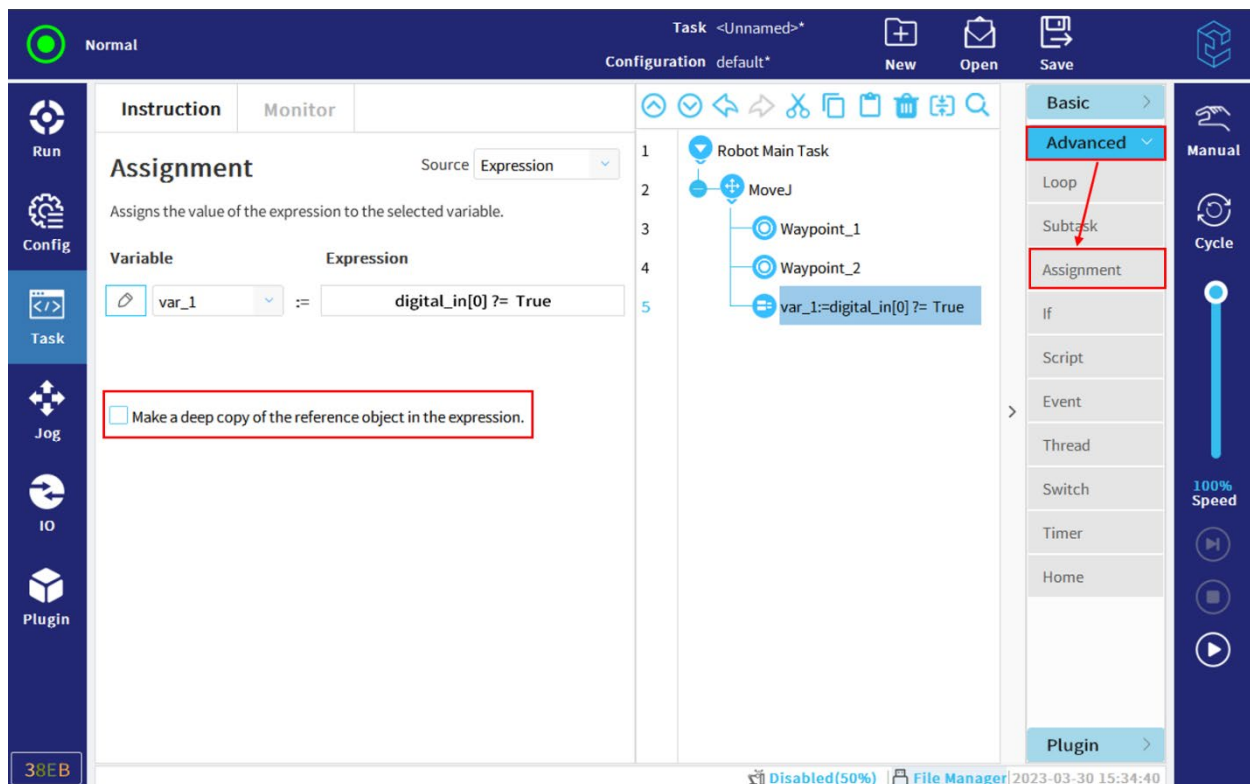



Figure 12-22 Assignment



The user can select a variable from the drop-down list. To rename the variable, click  and enter a new name in the text keyboard (note: the text keyboard supports for typing Chinese). To cancel the input, click the "ESC" key on the upper right to cancel the input. In the display, the user can select the checkbox in front of "Make a deep copy of the reference object in the expression" and when selected, the new copy of the node will not change with the source data. If not selected, the user makes a shallow copy of the node and the changes of the newly copied node will be subject to the source content.

The statement that assigns a certain value to a variable is called an assignment statement.

The source of assignment statement is:

- Expression: Custom assignment statement can be specified by IO, variable, pose or script function;
- Operator: After the user needs to operate in the pop-up window, the task will continue to run.
 - Yes or No: Select Yes or no in the pop-up window or "Cancel" twice to cancel the entry;

12 Task Tab

- A decimal integer: Enter an integer or click  twice to cancel input;
- A decimal fraction: Enter a decimal number or click  twice to cancel input;
- A text string: Enter a string or click "ESC" twice on the upper right to cancel the input.

12.5.4 If

If and If...Else statement structure can execute corresponding branches according to the expression.

1. Select "Task > Advanced > If".
2. Click "If" in the task tree to modify the expression, as shown in Figure 12-23.

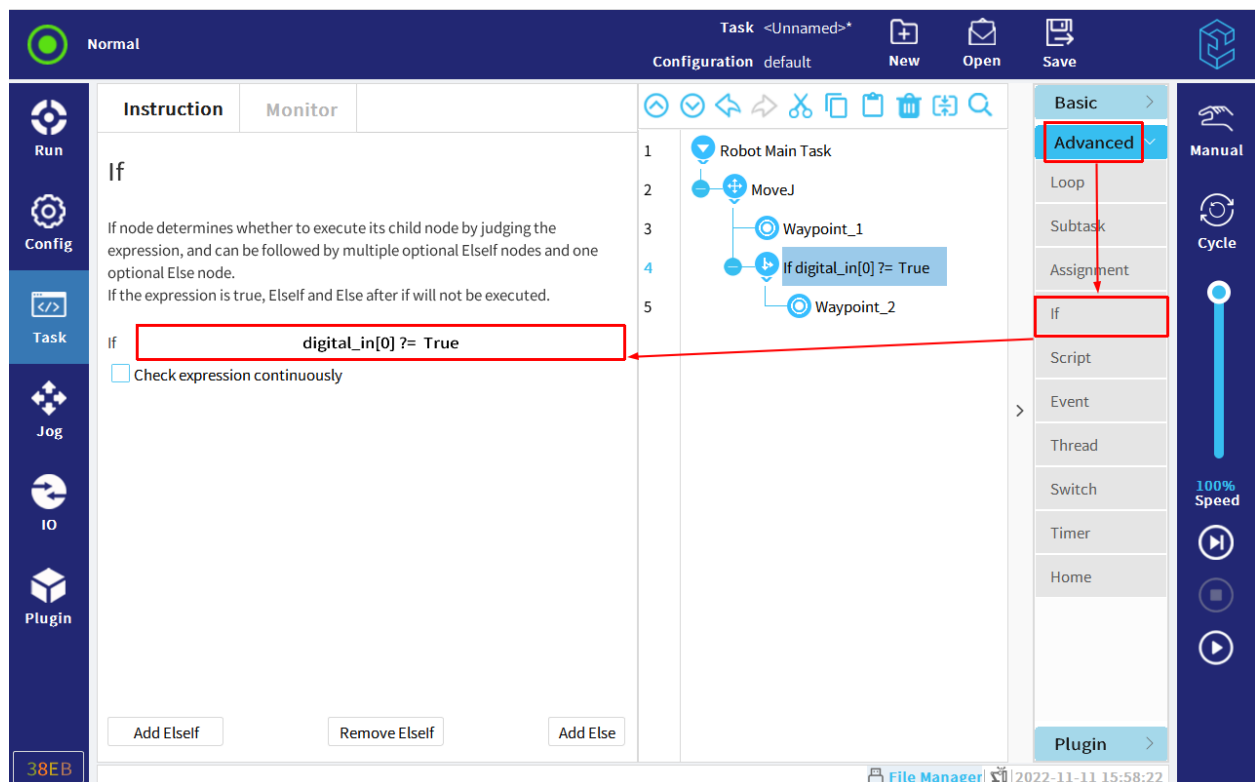

Figure 12-23 If

3. On the empty node, edit the node in If node.

If the expression is true, the node in If will be executed. An If statement can have at most one else statement.

Use "Add Elself" and "Remove Elself" to add or remove Elself expression.

If "Check expression continuously" is checked, it will always check whether the expression meets the trigger conditions when running the sub node of if. When the expression is not satisfied, the program will immediately jump out of the current If branch and continue to run the follow-up task.

12.5.5 Script

The drop-down list of "Script" provides the following options, as shown in Figure 12-24.

- "Line" allows users to write single line code using the expression editor;
- "File" allows users to load local existing script files; Or edit the script content directly and save it.

Please refer to the script manual for details about the script file.

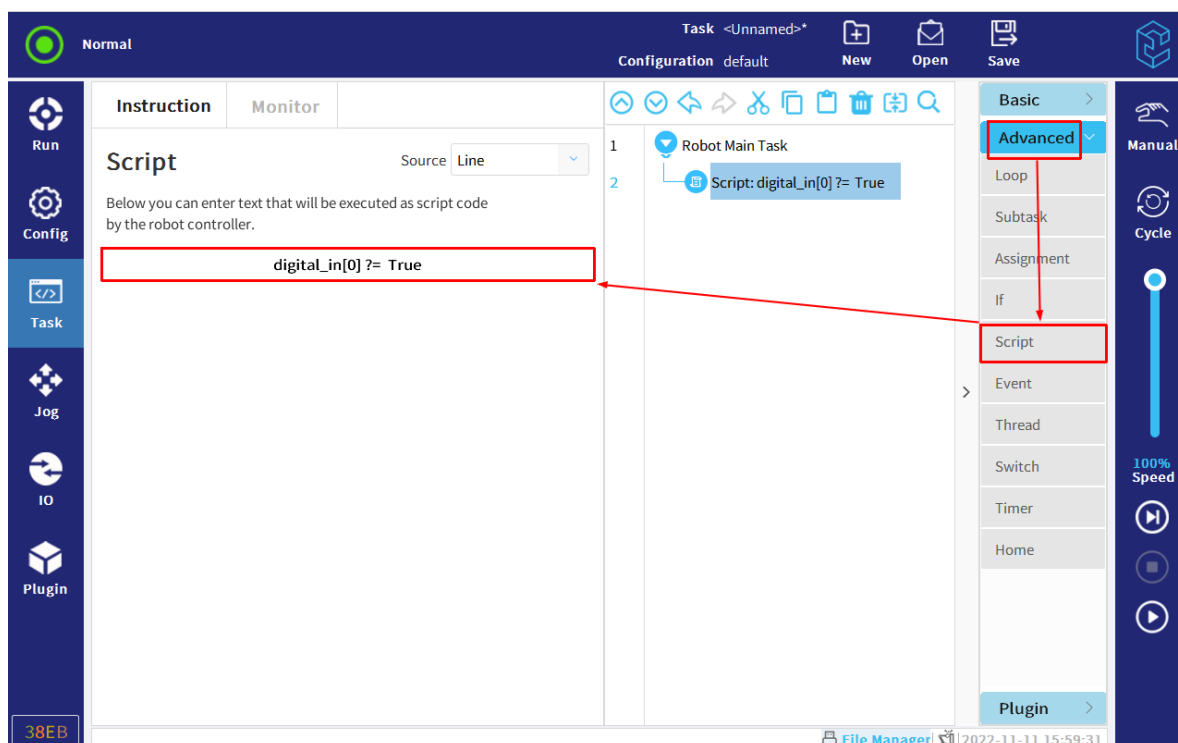

Figure 12-24 Script

12.5.6 Event

The "Event" node can be used to monitor the expression. When the expression is true, the child nodes in the "Event" will be executed. Expressions usually can include signals, task variables, etc. Therefore, the "Event" node is often used to monitor input signals or variables and execute child nodes when conditions are met. As shown in Figure 12-25.

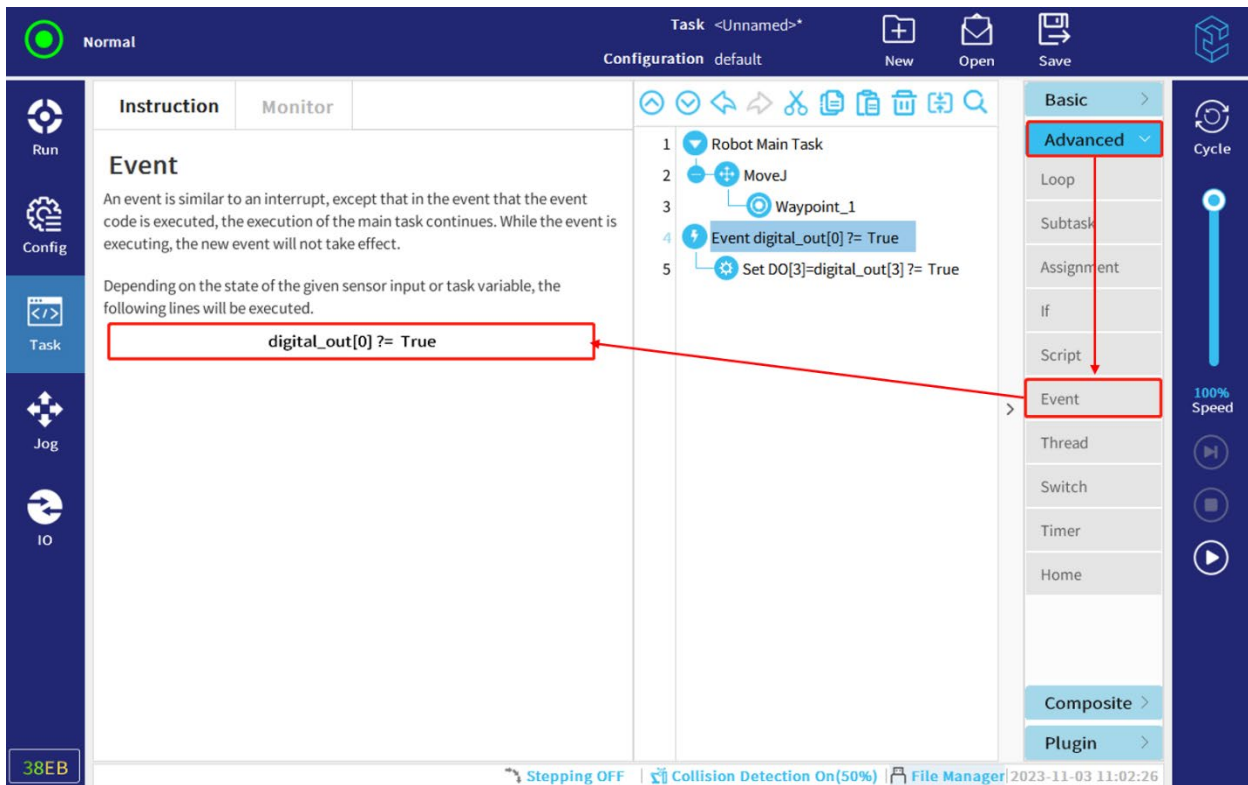

Figure 12-25 Event

12.5.7 Thread

Thread is a parallel task running together with the main task. It is a parallel process of robot task. It is mainly used to control external machines and is not recommended to control the movement of robot arm. Therefore, the "Thread" node is mainly used to execute IO actions, wait for signals and set variables, as shown in Figure 12-26.

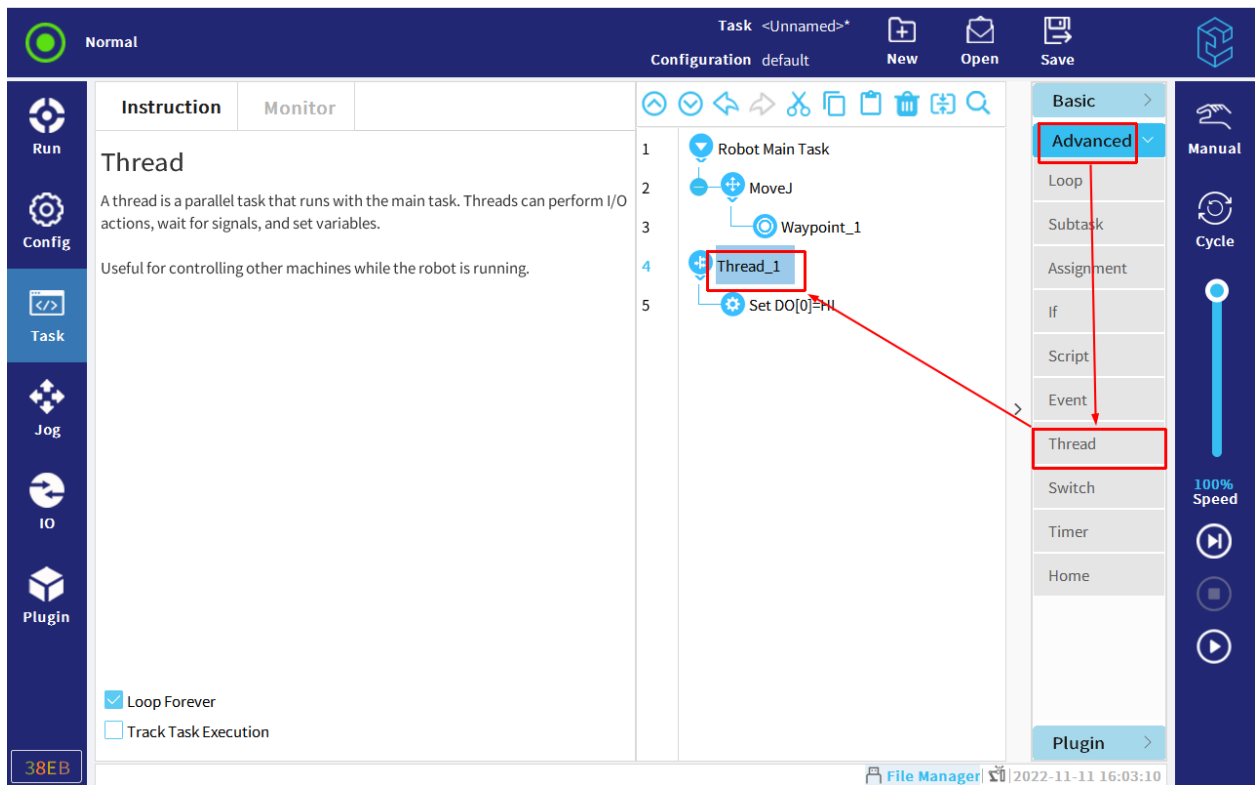

Figure 12-26 Thread

12.5.8 Switch

Each "Switch" node can contain multiple "Case" nodes and one "Default Case" node.

When running to the "Switch" node, the task judges the value of the expression first. If it matches the case value, the corresponding case node will be executed. If it does not match, the default case will be executed or none will be executed, as shown in Figure 12-27.

12 Task Tab

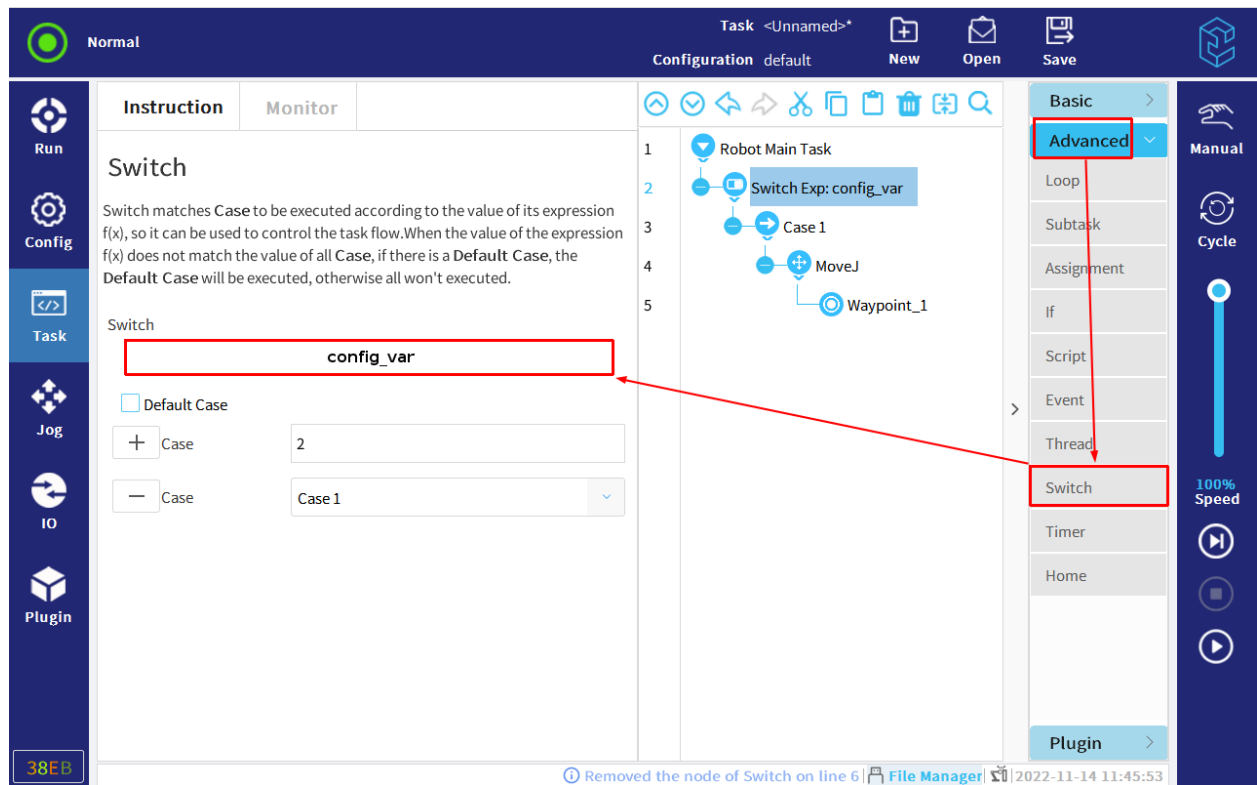

Figure 12-27 Switch

The user can fill in the value of the situation first, then add "Case" node.

12.5.9 Timer

A timer is used to measure time. The measured time appears in the variable, as shown in Figure 12-28.

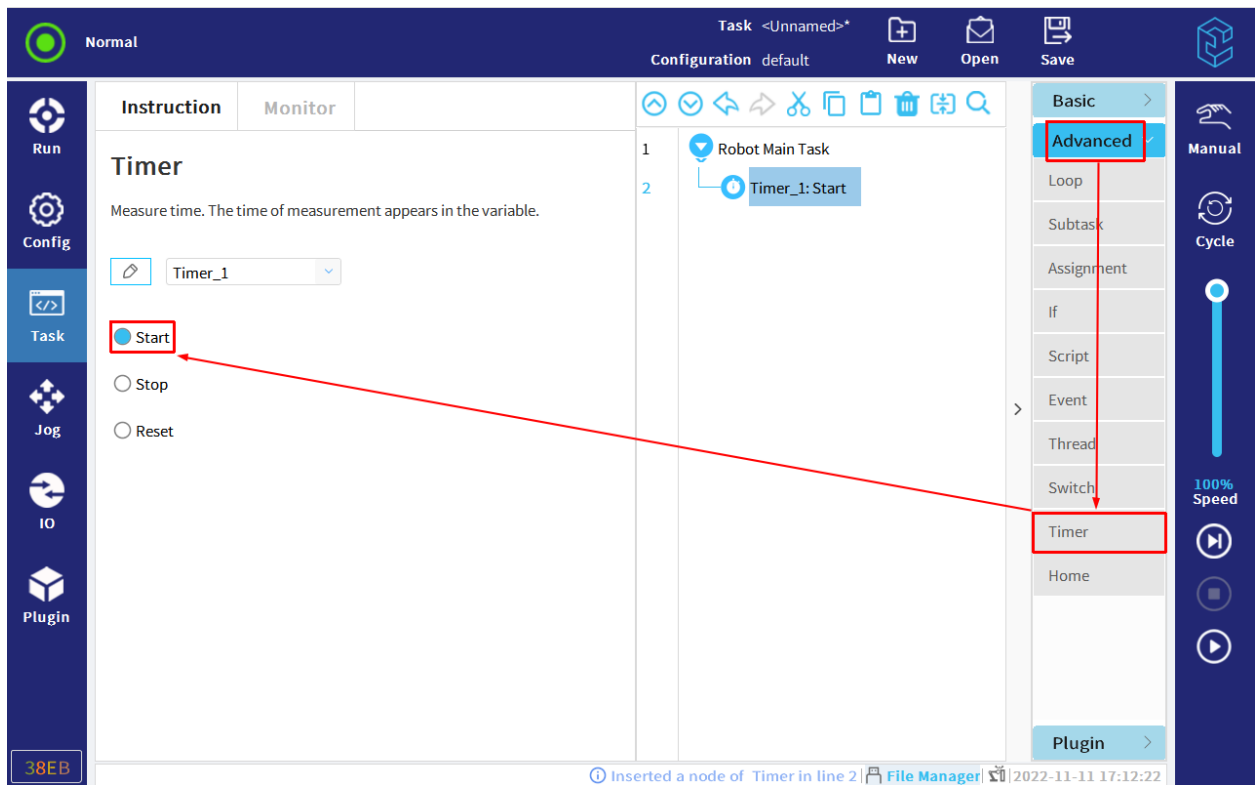

Figure 12-28 Timer

The timer nodes include:

- Start: the timer starts counting;
- Stop: the timer stops. The measured time can be viewed through the "monitoring > variables" interface;
- Reset: resets the variable value of the current timer.

12.5.10 Home

The user can run the robot to the home position defined in "Config > General > Home" and select "Active Home" or "Safety Home" from the drop-down list of the source, as shown in Figure 12-29. Please refer to section 11.2.1 for the details about the safety home, the section 11.2.4 for the details about the I/O settings and the section 12.4.2 for details about movement mode.

12 Task Tab

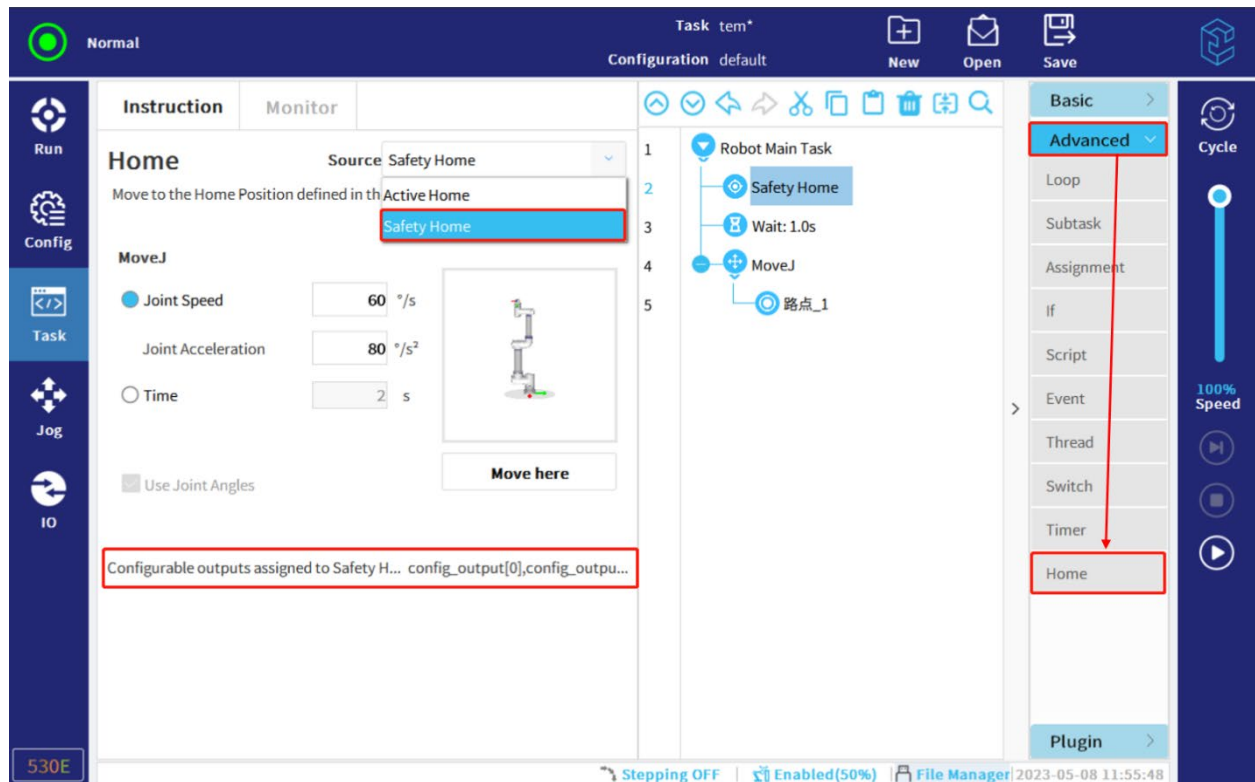

Figure 12-29 Home

12.6 Composite

12.6.1 Palletizing

Palletizing supports user-defined layout type, number of layers, reference points, etc. to write palletizing and depalletizing tasks.

12.6.1.1 Create Palletizing Task

The steps are as follows:

1. Choose "Task > Composite > Palletizing".
2. Set the palletizing task name, frame, and cargo height, as shown in Figure 12-30.

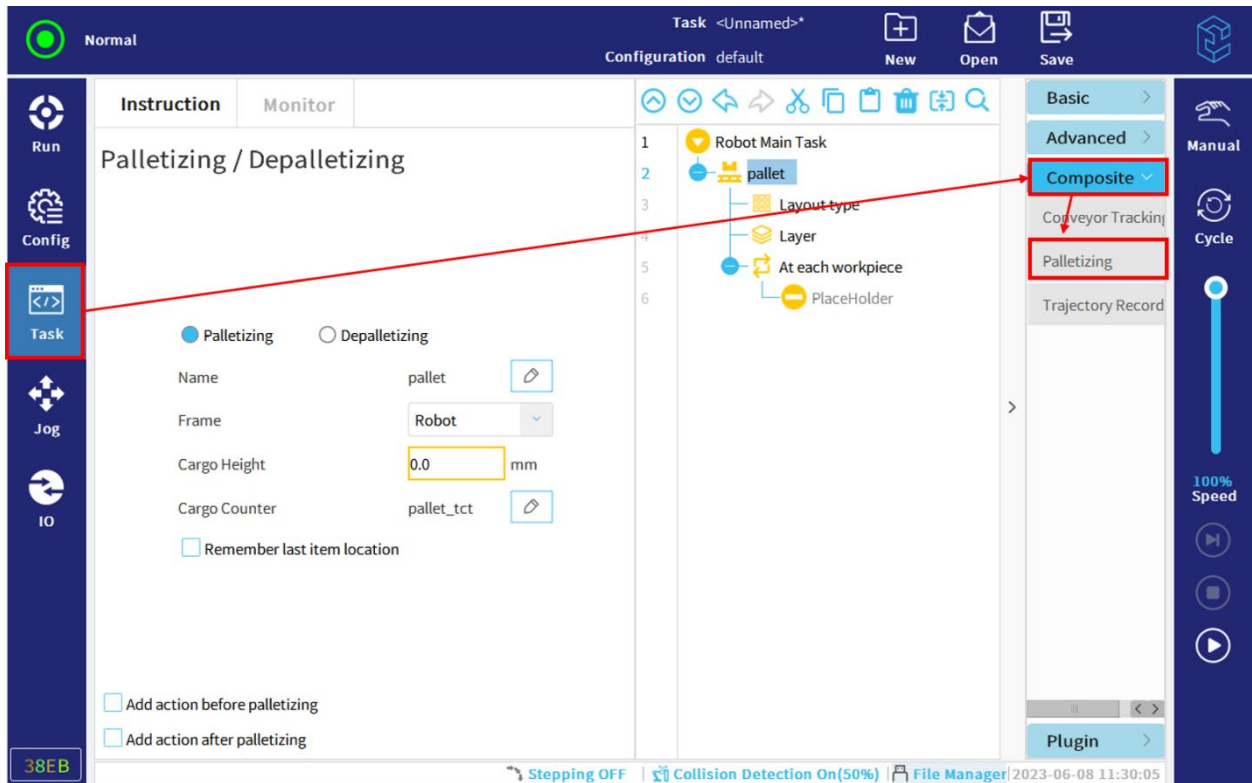

Figure 12-30 Set palletizing task parameters

- **Frame:** supports base and user-defined frame;
- **Cargo height:** the height of palletizing cargo;
- **Cargo counter:** Define a variable to calculate the number of palletized cargo. When the task is running, the user can view the variable value in "Monitor";
- **Add action before palletizing:** After checking, insert the "Palletize Before Action" node under the palletizing task, then the user can add actions based on the needs; If unchecked, the node will be deleted directly.
- **Add action after palletizing:** After checking, insert the "Palletize After Action" node under the palletizing task, then the user can add actions based on the needs. If unchecked, the node will be deleted directly.

12 Task Tab

3. Click the "Layout type" node in the task tree, then the user can set it to "Line", "Matrix" or "Custom", as shown in Figure 12-31.

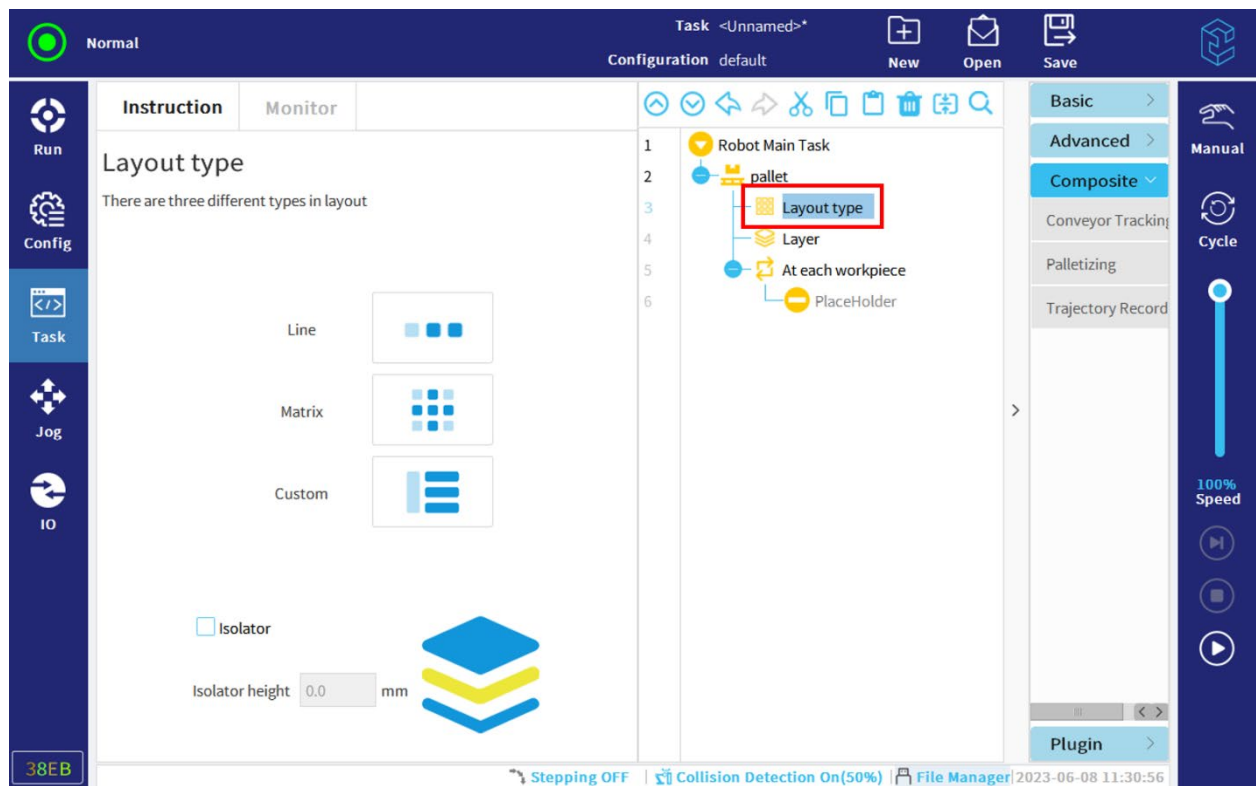

Figure 12-31 Set layout type

- Line layout: click the line layout node to access configuration window in Instruction tab. Line node can be renamed and set number of the workpiece;

Click the "Workpiece" nodes (named "LineItem_#" by default) to set the start position and end position of layout.

- Matrix layout: click the matrix layout node to access configuration window in Instruction tab. Matrix node can be renamed and set number of the rows and columns of the workpiece;

Click the four sub "Workpiece" nodes (named "MatrixItem_#" by default) under layout type to set the start position and end position of layout.

- Custom layout: configuration window in Instruction tab. Custom node can be renamed. "Workpiece" node can be added or delete;

Note: The "Workpiece" node of linear layout and Matrix layout cannot be deleted; The "Workpiece" node of custom layout can be deleted through the delete button on the "Instruction" tab.

- Isolation layer: isolator is the object that is sandwiched between two workpieces. After check "Isolator" under Layout type, "IsolatePoint" node will be insert under "Layout Type", and "Isolator action" node will be added to task tree. Then the user can add actions based on the needs. If unchecked, "IsolatePoint" node and "Isolator action" node will be deleted directly.

4. Click the "Layer" node in the task tree and click "Add layer" to set the number of layers of the pallet, the layout type of each layer, and whether to include the isolation layer, as shown in Figure 12-32.

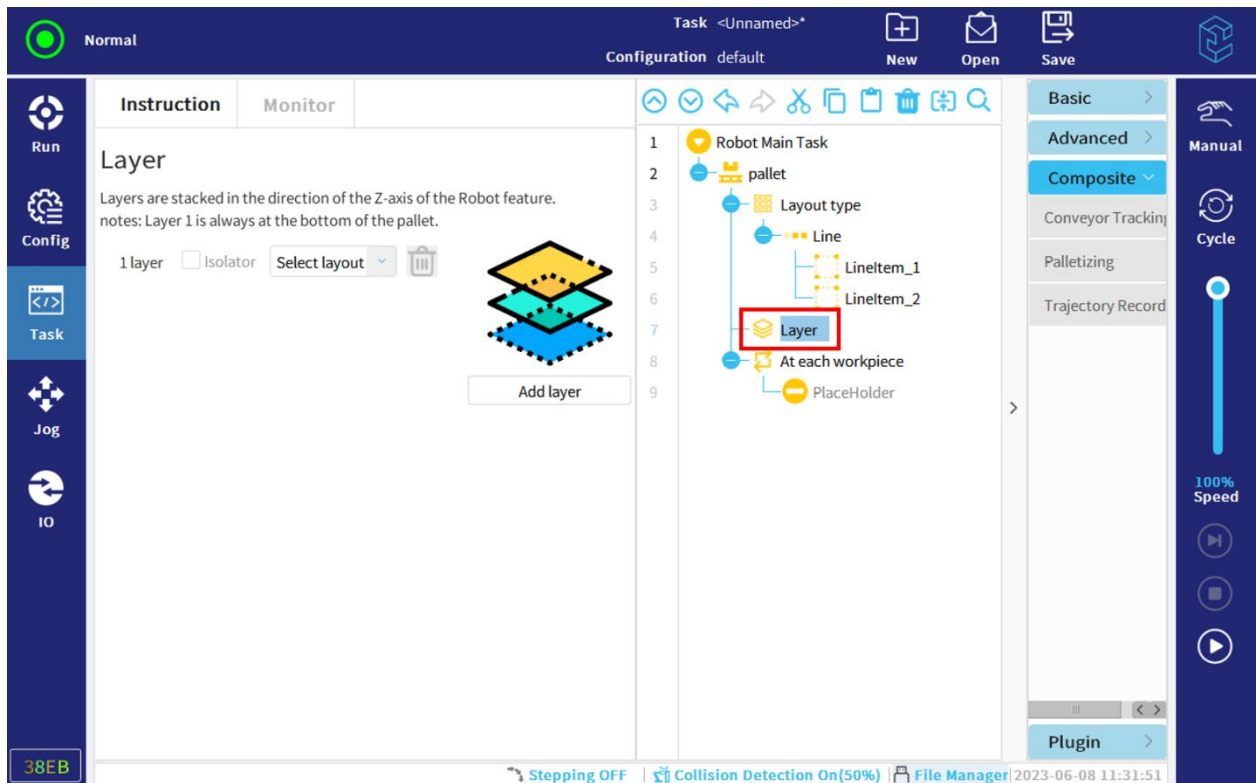

Figure 12-32 Set layer

5. Click the node "At each workpiece" in the task tree, and the user can set reference points and generate movement.

12 Task Tab

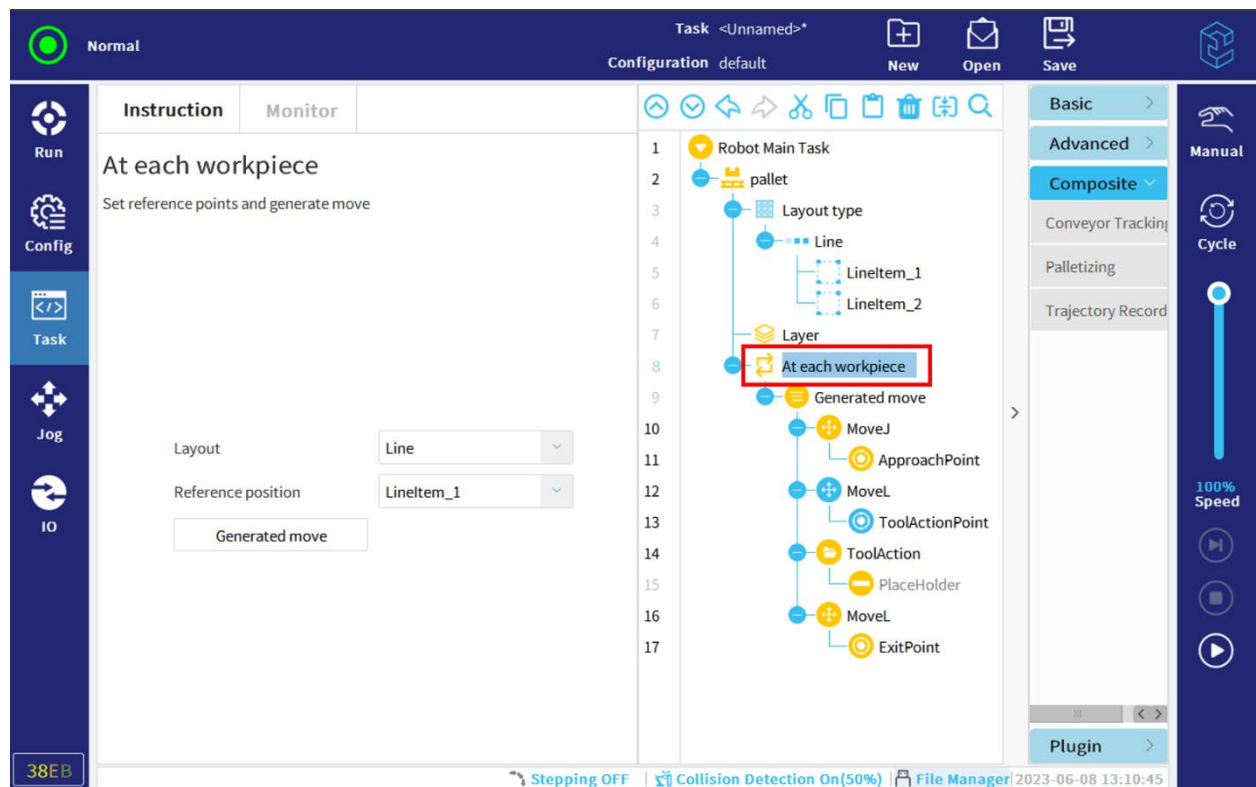

Figure 12-33 Set workpiece parameters

The reference point is generally the position of the first workpiece on the first layer. The user can directly select the "Workpiece" node in the drop-down list as the reference point, as shown in Figure 12-33.

Under the "Generated move" node, set the approach point, tool action point, tool action and departure point.

After setting, the tool will repeat these actions for each workpiece.

- Approach Point: approach the reference point without collision;
- Tool Action Point: The default is the reference point, which can be modified according to actual needs;
- Tool Action: under the "Tool Action" node, add the corresponding tool action;
- Exit Point: leave the reference point without collision.

6. Under the "Isolator action" node, click "Generate isolation action".

The user can set the "pickup isolator" node and set the approach point, isolator action, tool action and exit point.

12.6.2 Conveyor

The conveyor function uses Modbus as a communication means to obtain the real-time operation data of the external drive belt and realize the tracking of the conveyor.

12.6.2.1 Configure Modbus Client

1. Click "Config > Communication > Modbus" to enter the "Modbus client IO setting" interface.

2. Click "Add Modbus device".

3. Set the "IP address", "Name", "Address", and "Type" of the device.

Note: The type must be set to "Register Input".

12.6.2.2 Configure Conveyor Parameters

1. Click "Config > General > Conveyor Tracking" to enter the "Conveyor Tracking Setup" interface.

2. Check "Enable conveyor tracking" in the upper right corner.

3. Set "Encoder type" to "Absolute".

4. Select "Encoder count variable" as the "Modbus" setting, as shown in Figure 12-34.

12 Task Tab

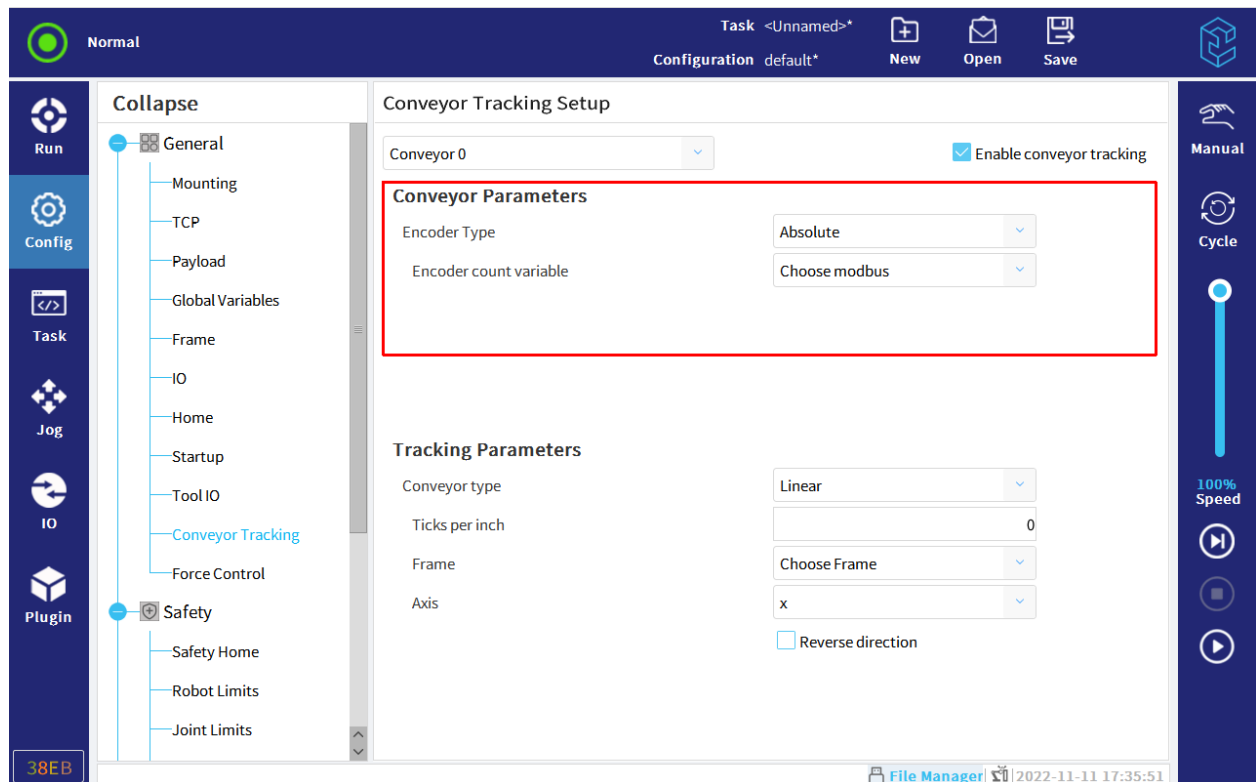

Figure 12-34 Configure conveyor parameters

5. Set "Tracking Parameters" and select "Conveyor type" as "Linear" or "Circular".

- **Linear:**
 - "Ticks per inch" is determined by external hardware equipment;
 - Select frame as the frame taught by "Config > General > Frame" and specify the running direction (determined by axes: x, y, z and whether to reverse).
- **Circular:**
 - "Ticks per revolution" is determined by external hardware equipment;
 - Select "frame" as the frame taught through "Config > General > Frame". By default, it rotates in a positive direction around the Z axis of the frame;
 - Check "Rotate tool and conveyor" to allow the end effector to rotate and track the target conveyor.

12.6.2.3 Select Conveyor

Select "Task > Composite > Conveyor Tracking" and select the conveyort type, as shown in Figure 12-35. The robot main task is under the node of conveyor tracking, and the fixed plane is stationary relative to the conveyor.

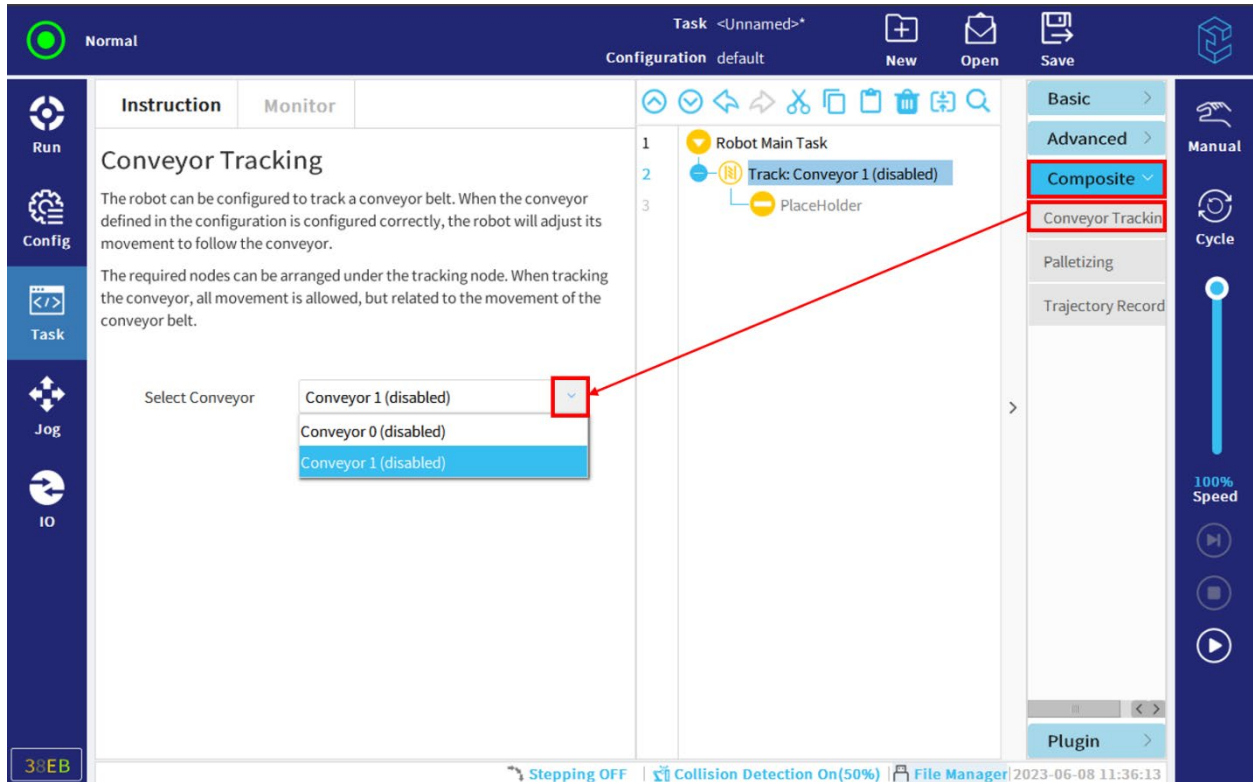

Figure 12-35 Conveyor

12.6.3 Trajectory Record

The function allows the user to record the robot trajectory over a period of time and to reproduce it.

The steps are as follows:

1. Click "Task > Composite > Trajectory Record" and enter the trajectory recording display.
2. Click "Start Record", the robot will record the path automatically and the grey icon (Not recorded) will turn to orange (Recording).

12 Task Tab

3. Click "Stop Record", the robot will stop recording the path. After the record, the orange icon (Recording) will turn to green (Recorded).

4. Click "Stop Re-record", the robot will start to make a record again and the previous path will be overwritten, as shown in Figure 12-36.

To restore the path which has already been recorded previously, the user must save that task file first before the version update and load the previously saved trajectory file then.

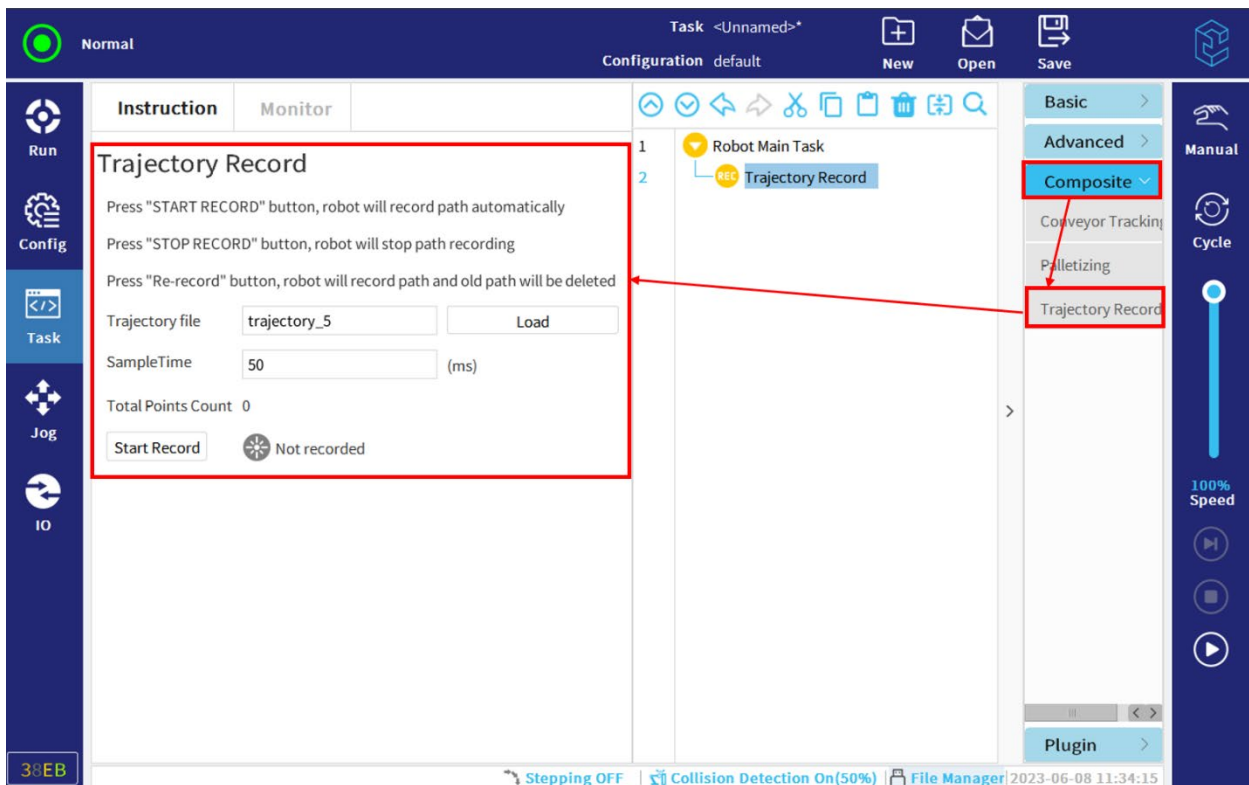

Figure 12-36 Recording the trajectory

12.7 Plugin

The user can install some plugins as required for greater functionality. Click "Task > Plugin" to find the task plugin nodes that have already been installed.

12.8 Breakpoint debugging

The function allows the user to set the breakpoint before or after the node. It is composed of a red spot and a red line. The red spot means that the program will stop at the point. The red line indicates when the function will be triggered.

- If the red line is above the red spot, it indicates that the function will be triggered before running the node;
- If the red line is below the red spot, it indicates that the function will be triggered before running the next node;
- When the red spot turns dark, it indicates that the function has already been triggered and the task is paused.

The user can set the breakpoint by clicking the line number of the node. To cancel the breakpoint, the user can click the line number again.

In addition, the user can also set and delete the breakpoints dynamically when the task is running. The changes will take effect when running the same task next time.

Please note that it is impossible to set the breakpoints in some nodes, i.e. the compressed node, the place-holder node, the thread node and other nodes in the plugin that do not allow the users to insert from the command line (e.g. the layer node and the layout node in the palletizing). For the line of nodes, the color of the line number is lighter.

- If these nodes are selected, the line number goes to light blue (see the line number “5” in Figure 12-37);
- If they are not selected, the line number is marked as light grey (see the line number “3” in Figure 12-37).

12 Task Tab

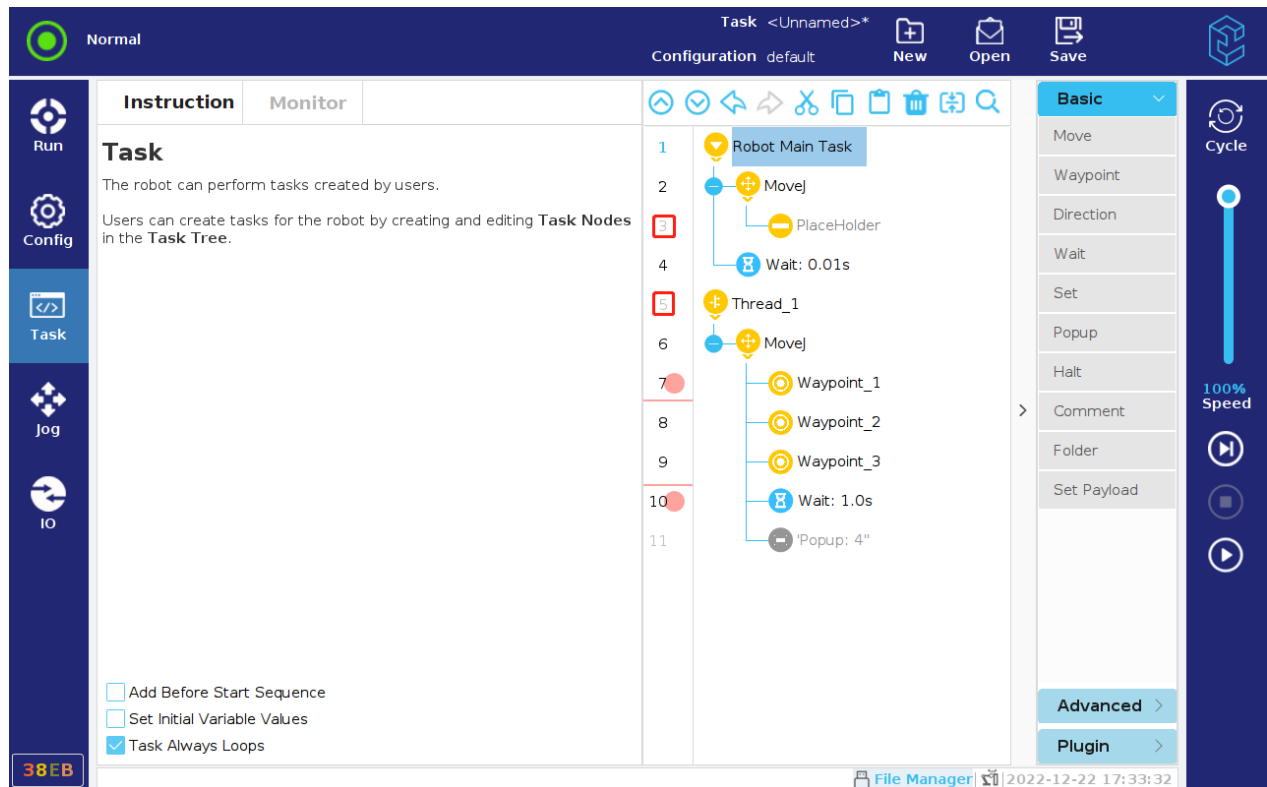

Figure 12-37 Breakpoint

12.9 Single-step function

The function allows the users to run a node in the single-step mode, incl. the movement nodes and the thread nodes. The currently running task can be paused by clicking the “Pause” button in the right side of the menu. After the pause, the single-step button will be highlighted. Click the button and the node will run. The user can dynamically switch over between the running states in the single-step mode and non single-step mode. This will not stop the proceedings of the current running task. Here are the notes:

- Please set a breakpoint in the main task of the program if the user expects to execute the single-step function from the first node. After the program starts, the task will be paused and the single-step function can be carried on then;
- The next node of the single-step function is namely the next thread node where is set a breakpoint. If other threads are set the breakpoints, then it will switch over to the other threads;
- The motion node of the operation in the single-step mode will go directly to the target point;

- If the user executes the single-step function after clicking the “Pause” button in the process of moving the waypoints, the next task node will be paused. The user will not enter the single-step mode until the next task node is triggered.

13 IO Tab

This chapter mainly describes the options and operation instructions in the IO setting of CS620 robot, including robot, Modbus and other options. The user can monitor and set the real-time IO signals sent and received by the robot.

13.1 Internal

13.1.1 Robot

On the screen, in the "IO" tab, the user can monitor and set the real-time IO signals sent and received by the robot.

This page displays the current status of IO, including IO status during task running. When the task stops running, all output signals will remain in their state, as shown in Figure 13-1.

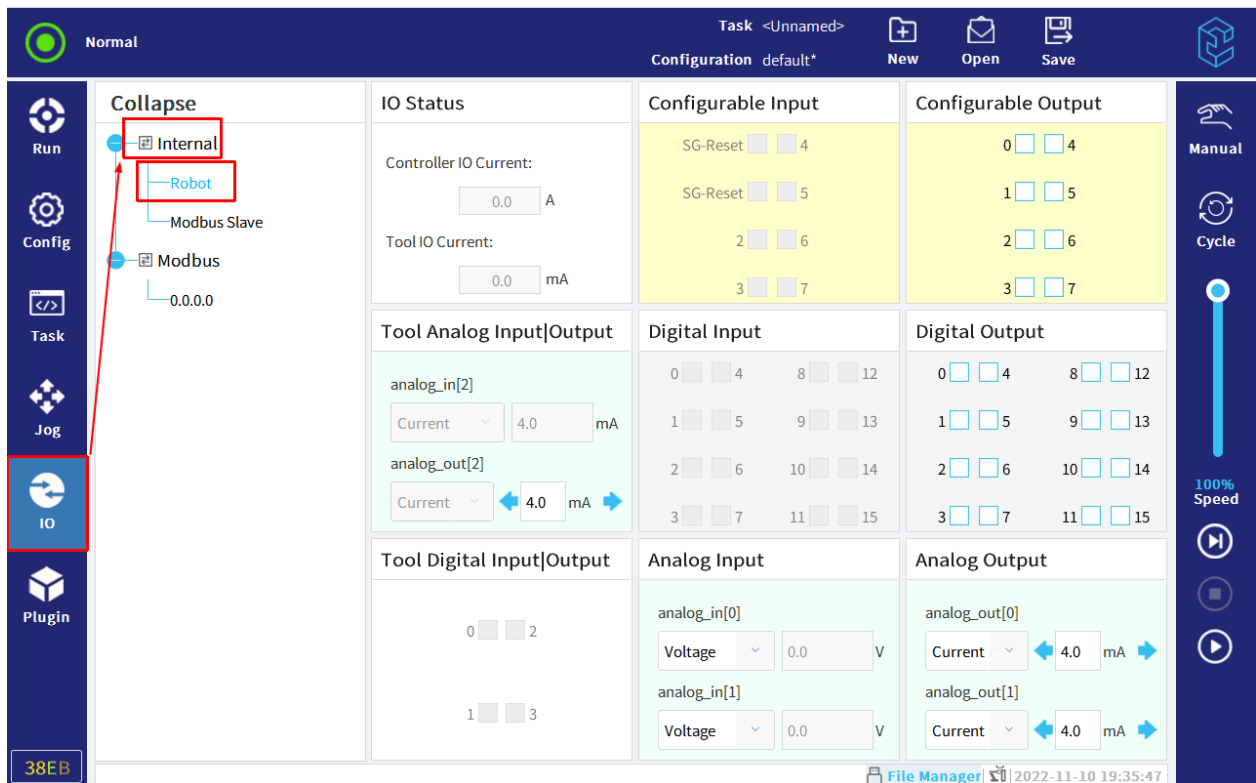

Figure 13-1 IO current status

Note: If the signals change too fast, then their status may not be displayed correctly.

Configurable IO can be modified under “Config > General > IO” or “Config > Safety > Safety IO”. After configuration, the IO table will display the function name instead of default name or user-defined name; and the corresponding configurable output cannot be switched.

Analog input / output setting: analog output can be set with current of 4-20mA or voltage of 0-10V. Analog input can view the specific value of current or voltage.

When the tool communication interface is activated, the tool analog input and output will not be available. See section 11.1.9 for details.

13.1.2 Modbus Slave

When Elite robot controller is used as a Modbus slave, it shows the slave status and slave protocol. The functions, meanings and configuration descriptions of various registers of Modbus Server are shown in Figure 13-2.

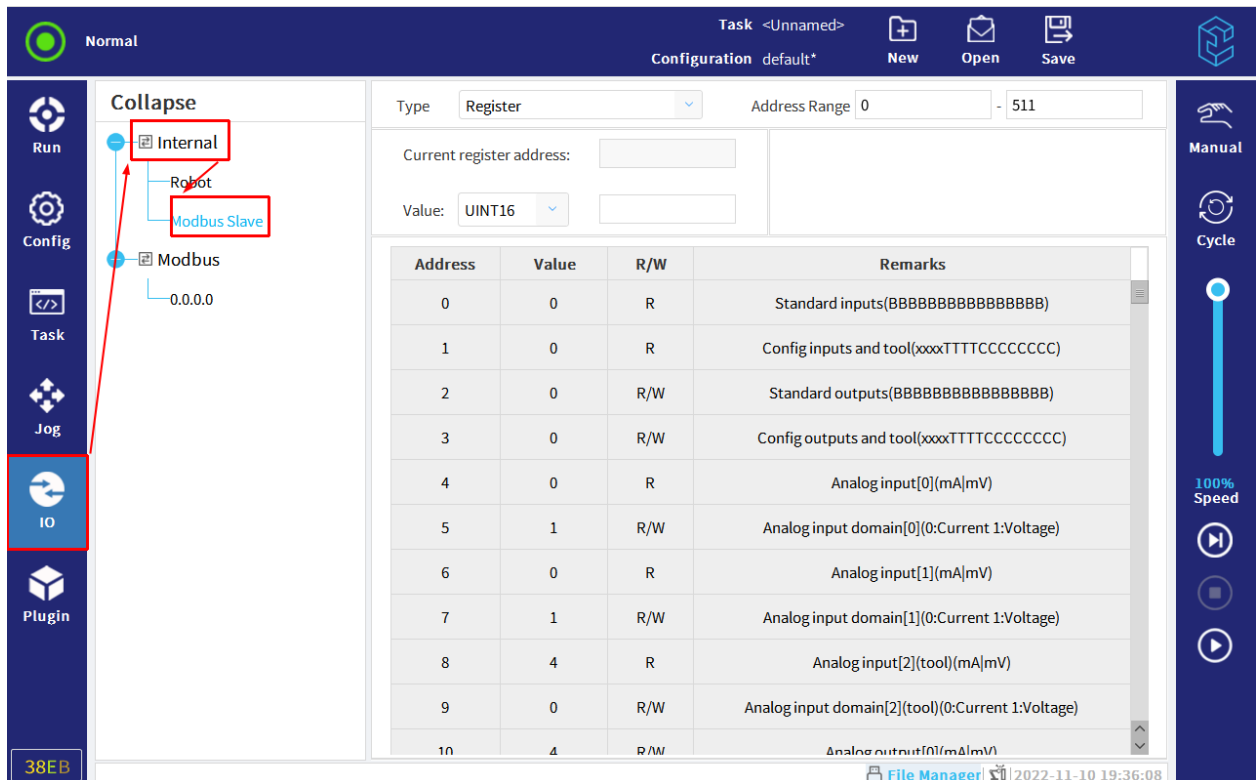

Figure 13-2 Modbus Slave

13.2 Modbus

This section shows the Modbus client IO signals added in “Config > Communication > Modbus”.

If the number of settings is more than one, use the drop-down menu at the top of the page to change the displayed content according to the signal type. Each signal in the list contains the connection status, value and address, as shown in Figure 13-3.

If the connection succeeded and the "I/O tab control" of “Config > General > IO" configuration output Modbus is "Enabled", the user can set the output signal.

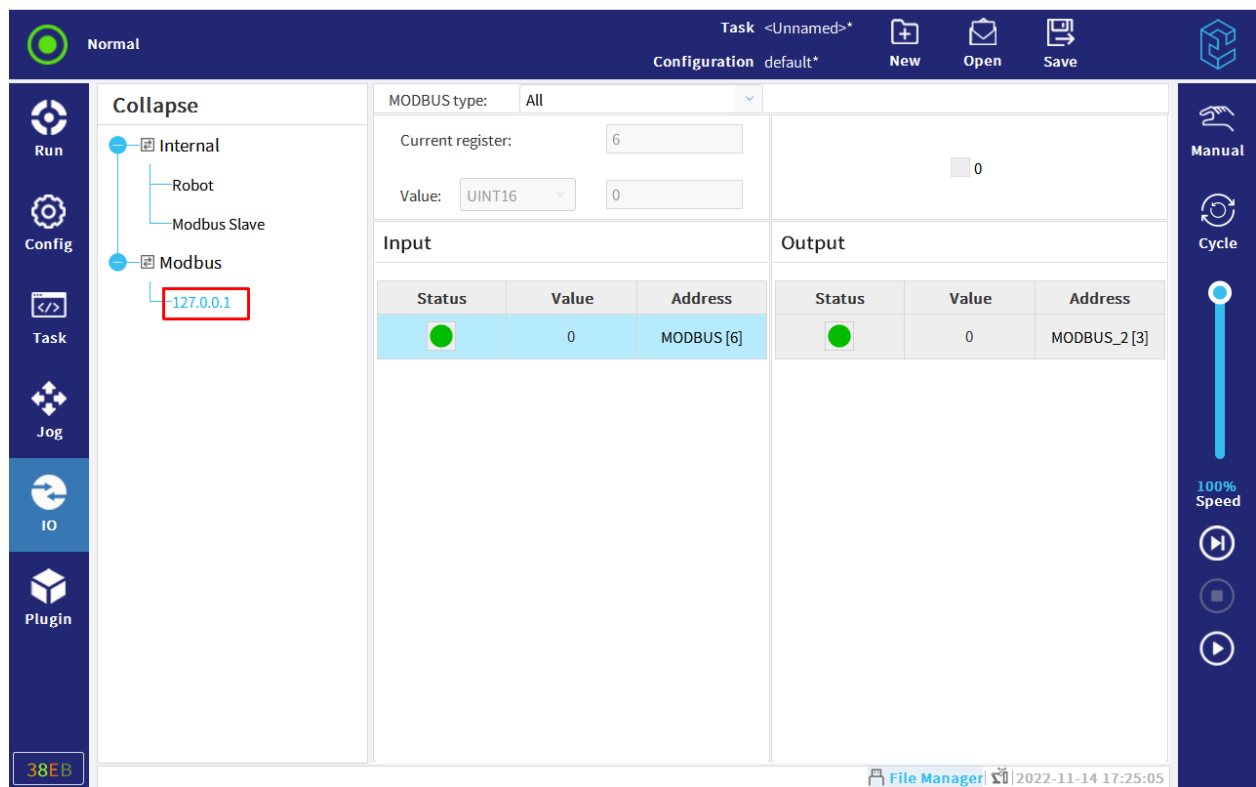

Figure 13-3 Modbus

14 Jog Tab

This chapter mainly describes the options and instructions under Jog Tab for CS620, including robot, tool position, joint position, editing pose page, move interface, etc. The user can set the tool and frame setting in the robot, carry out origin, drag and operation, and carry out tool translation or tool orientation in the joint position.

As shown in Figure 14-1, the user can operate the robot motion by translating, rotating the robot tool or moving the robot joints one by one.

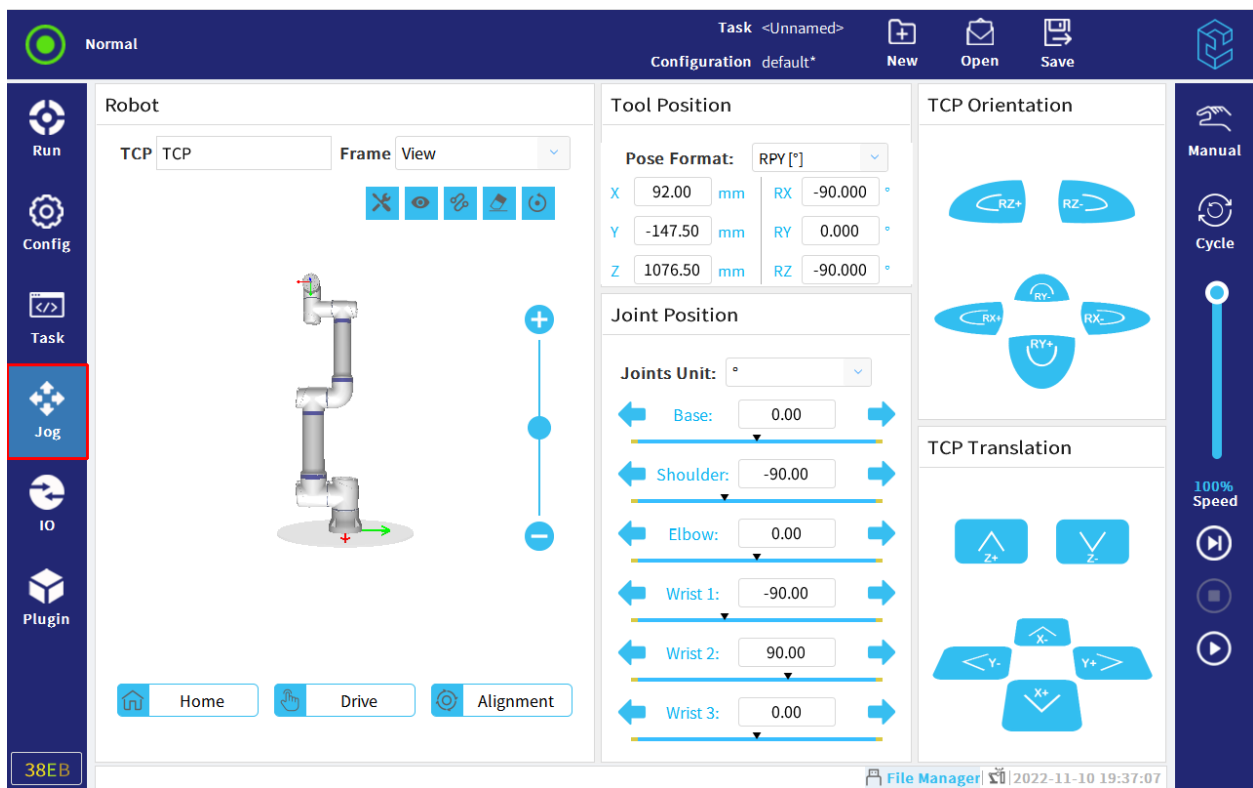

Figure 14-1 Jog the robot

14.1 Robot

14.1.1 Tool and Frame

TCP: the currently active TCP. To switch, go to the “Config > General > TCP” interface. For details, see section 11.1.2.3.

14 Jog Tab

Frame: coordination of the robot, the frame can set as observation, base, tool or user-defined frame.

The difference of frame is as follows:

- View: keep the view pose consistent with the robot pose currently observed by the user. Always keep the x-axis of the frame facing itself and the z-axis upward. Under the observation frame, the pose data under the tool position has no practical significance;
- Tool: The currently active TCP;
- Robot: base frame;
- Custom frame: Frame added by the user under "Config> General > Frame".

Note: To facilitate the movement of robot arm, the user can observe the frame, then use "TCP Translation" and "TCP Orientation" to move then robot.

14.1.2 Home, Drag, and Alignment

The user can also perform the following operations:

- Home: The robot returns to the currently active origin set in "Cconfiguration > General > Home";
- Drag: Hold "Drag" to drag the robot;
- Alignment: Keep TCP and the currently selected frame parallel in XOY plane.

14.2 Tool Position

The tool position displays the coordinate value of the currently active TCP relative to the selected frame. X, Y, Z coordinates specify the tool location. RX, RY, RZ coordinates specify the direction.

The user needs to select the representation form of the direction in the drop-down menu of "Pose Format":

- RPY[rad]: Roll, pitch and yaw angles expressed in radians;

- RPY[°]: Roll, pitch and yaw angles expressed in degrees.

14.3 Joint Position

Specify the position of each joint directly. Limits of the joints can be set in "General > Safety > Robot limits".

The user can perform the following operations:

- Click the input box to enter the desired angle. See section 14.4 for details;
- Click the arrow buttons to increase or decrease the current value.
- Click the "Stepping" icon in the bottom of the menu to switch on or off the stepping mode, as shown in Figure 14-2.

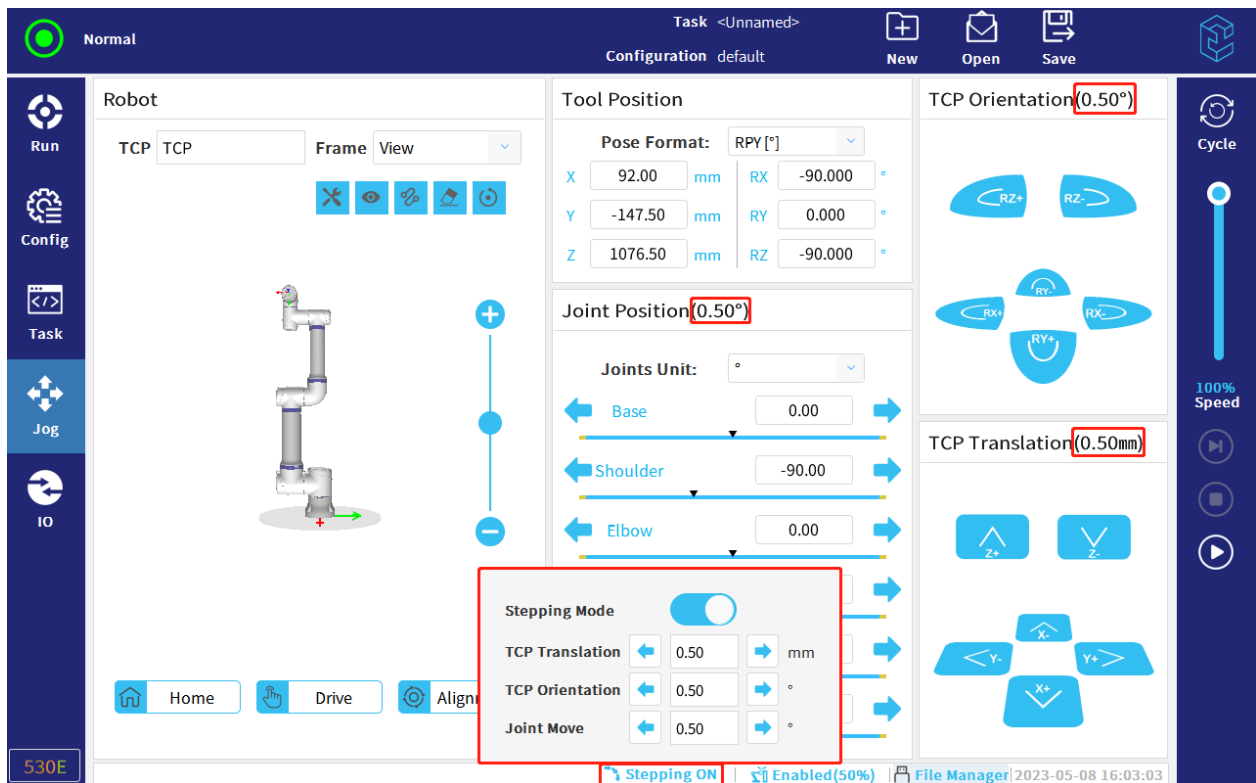

Figure 14-2 Stepping mode

14.3.1 TCP Translation or TCP Orientation

Under the selected frame, press and hold the "TCP Translation" or "TCP Orientation" arrow to move the robot arm in a specific direction.

14.4 Edit Pose Page

The user can also click the input boxes of the "Tool Position" or "Joint Positions" to enter the "Edit Pose" page, as shown in Figure 14-3.

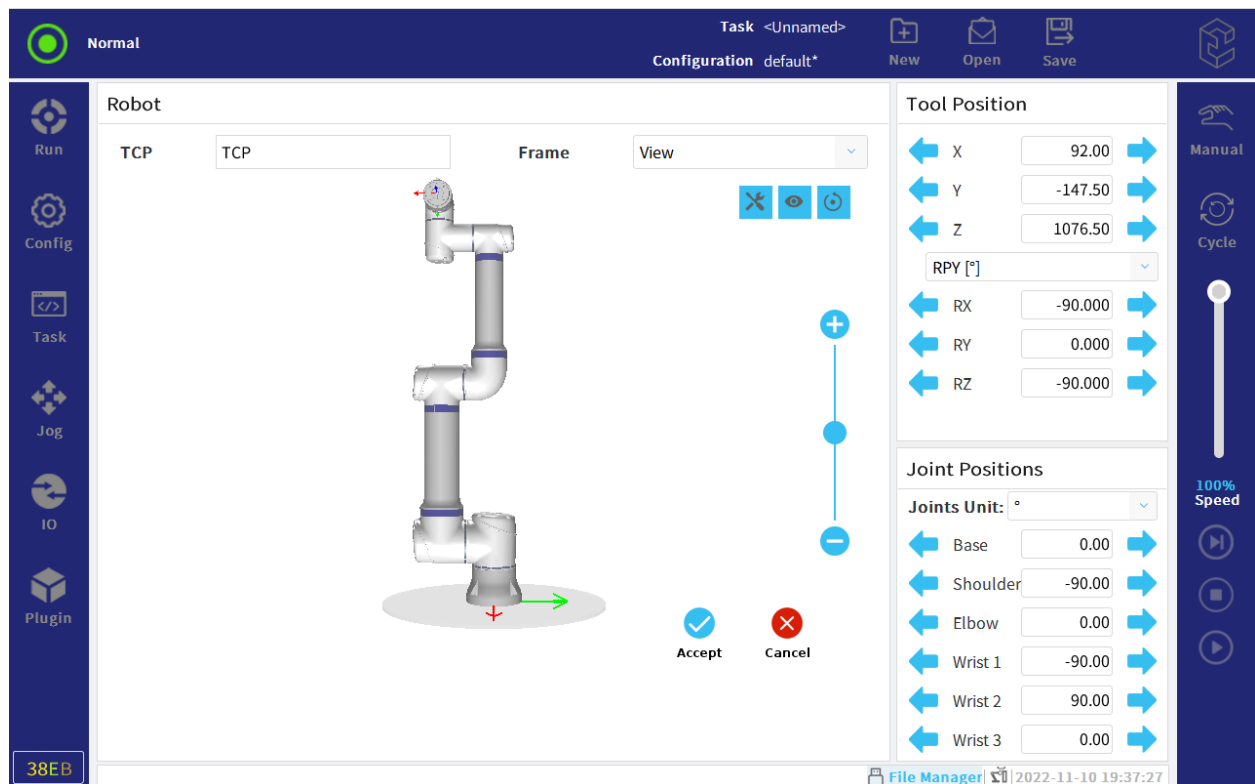

Figure 14-3 Edit pose

On the "Edit Pose" page, the value of joint position or tool position can be directly entered. After input, a transparent image of the target pose will appear in the view.

When the left arrow is hold: the number in the input box will reduce the value. The transparent robot image previewing the target pose will update synchronously;

When the right arrow: the number in the input box will increase the value. The transparent robot image previewing the target pose will update synchronously;

When the left arrow is tapped: an input keyboard will pop out. After inputting the value with the keyboard, the number in the input box will subtract the value inputted with the keyboard, and the transparent robot image previewing the target pose will update instantly.

When the right arrow is tapped: an input keyboard will pop out. After inputting the value with the keyboard, the number in the input box will add the value inputted with the keyboard, and the transparent robot image previewing the target pose will update instantly.

Once the value adjustment is done, press "Accept" button, then the screen will enter Move Interface.

14.5 Move Interface

After editing pose completed, the screen will automatically jump into Move Interface as Figure 14-4.

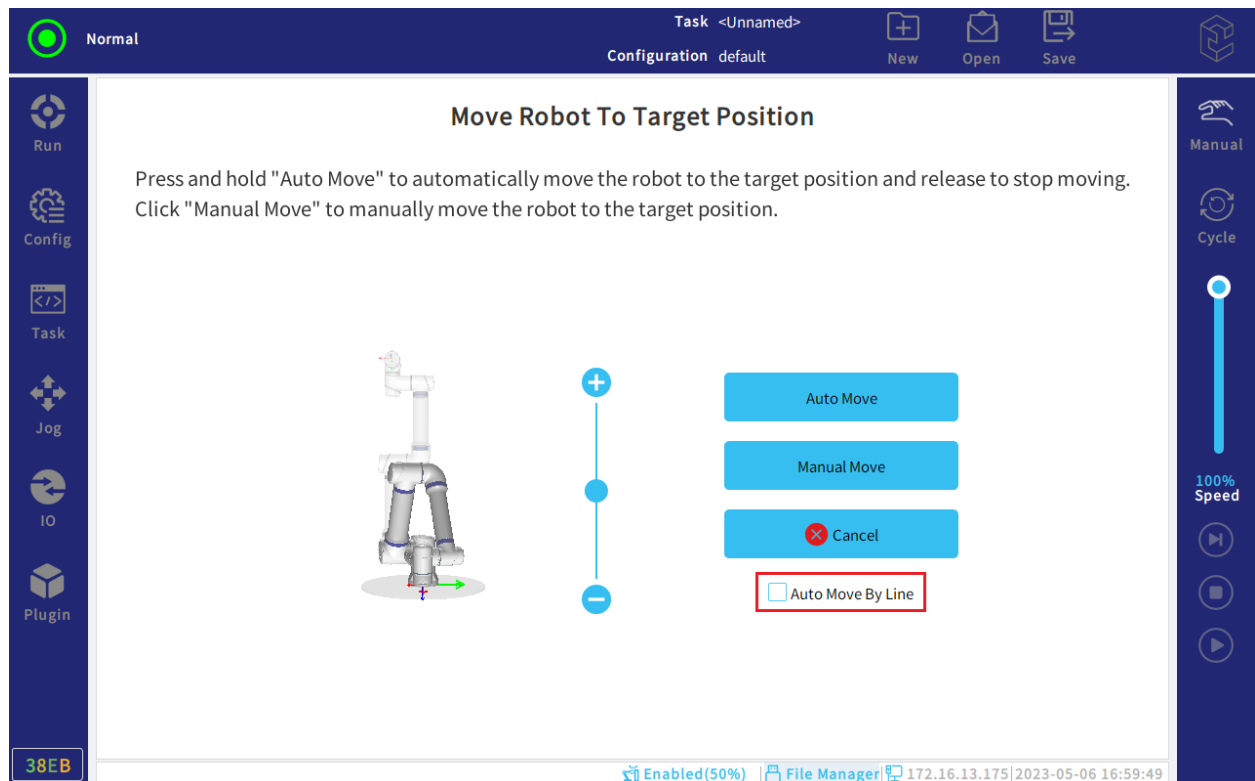

Figure 14-4 Move Interface

14 Jog Tab

The user can select "Manual Move" or "Auto Move" to move the robot to the target pose. After selecting the check-box "Auto Move By Line" and long press "Auto Move", the robot will be moved in a straight line (MoveL) to the target position.

15 Bus Protocol

15.1 Introduction

The CS620 robot supports Modbus, RTSI, Profinet, 30001, 29999, and other bus protocols.

15.2 Modbus Protocol

15.2.1 Introduction

Modbus is a serial communication protocol, which was published by Modicon (now Schneider Electric) in 1979 for the use of Programmable Logic Controller (PLC) communication. Modbus has become the industry standard (Defacto) of the communication protocol in the industrial field, and is now a common connection method between industrial electronic devices.

The Elite CS series supports obtaining or modifying the internal data of the robot through the standard Modbus TCP protocol. It can be used as a master station to access other slave devices that support the Modbus protocol; it can also be used as a slave station to accept access requests from other Modbus master stations. This article mainly introduces some of its characteristics as a slave.

15.2.2 Working Principle

The Modbus TCP protocol works at the application layer of the OSI network model, and uses TCP for data transmission. When the controller acts as a server, the client establishes a connection with it via TCP port (502), and uses standard format application layer messages for data communication. The slave station can be accessed by multiple master stations at the same time.

TIPS



The Modbus slave device is always the requested station, so it is also called Modbus Server, and the master device is also called client.

15.2.3 Register Description

The data types supported by the CS series that can be read and written using the Modbus protocol are boolean and unsigned short integers (16 bits). Each type contains a set of input and a set of output registers, so there are 4 sets of registers in Modbus that can be accessed by the master station. Among them, the input type register only allows the read operation, the output type register is readable and writable. For detailed description of register protocol interface, please visit the website: www.eliterobots.com.

1. Boolean register (8 bits): mainly used to manipulate digital IO, the effective address range of the digital IO register currently accessible by the CS series is 0-63, although the value type is bool, each IO still occupies one byte of space, so digital IO occupies a total of 2*64 bytes.
2. Unsigned short integer (16 bits): used to save and modify the robot version, TCP, system status and other information; also used to map digital IO. The effective address range of the input/output registers currently accessible by the CS series is 0-415.

15.2.4 Modbus Function Code

The Modbus master device can read/write slave registers through the following function codes:

1. 0x01: read one or more output digital signals (read output bits)
2. 0x02: read one or more input digital signals (read input bits)
3. 0x03: read one or more output registers (read output registers)
4. 0x04: read one or more input registers (read input registers)

5. 0x05: write a single output digital signal (write output bit)
6. 0x06: write a single output register (write output register)
7. 0x0F: write multiple output digital signals continuously (write multiple output bits)
8. 0x10: write multiple output registers continuously (write multiple output registers)

15.2.5 Modbus Function Code

Exception codes and meanings are as follows:

- 2: Disconnect.
- 1: Connecting.
- 1: The signal type is incorrect.
- 2: The slave register (coil) address is incorrect.
- 3: The value is incorrect.
- 4: Slave exception.
- 5: The master station received a message that the slave station might time out.
- 6: The slave station is busy.
- 8: The slave parity check error.
- 10: The gateway is misconfigured or overloaded.
- 11: The failure to receive a response from the slave usually means that the slave is not in the network.

15.2.6 Register Mapping Relationship and Configuration Instructions

15.2.6.1 Digital IO and Register Mapping

In the CS series of equipment, there are 64 operable digital IO. The first 32 IO addresses are closely related to the general IO on the motherboard of the controller. The remaining 32 addresses are reserved for subsequent development.

Therefore, the digital IO is currently mapped to the Modbus register. The specific mapping relationship is:

Standard digital input -----> Register address: 0

Configurable digital input and tool IO -----> Register address: 1

Standard digital output -----> Register address: 2

Configurable digital output and tool IO -----> Register address: 3

The mapping above shows the unsigned IO register is 16 bits per register address. The value of each bit from low to high represents the state of a digital IO signal. For example, on the unsigned register address 0, if the register value is 0x2 (the first bit is set to 1), it means the value on the digital input bit address 0 is set to 0; the value on the bit address 1 is set to 1; and the values on the bit addresses from 2 to 15 are all set to 0.

15.3 RTSI Protocol

15.3.1 Introduction

RTSI (Real-time Synchronization Interface) provides a standard TCP/IP connection for real-time data interaction with external programs.

Interactive data content such as:

- Output: the robot outputs values of integer registers, terminal load, etc;
- Input: status settings for the robot float input register and digital input IO.

RTSI consists of three steps: protocol check, setting, and synchronization. Because the protocol will be updated iteratively, when the RTSI client is connected, the protocol version needs to be verified first to determine whether the communication can continue. Note: The protocol is version 1. When the version verification is able to communicate, the subscribe variables need to be configured. After verification and configuration are completed, send the start signal to start communication.

When linked to the RTSI server, the client is responsible for setting the variables to subscribe to. The clients can subscribe to any combination of input or output subscribable items. To do this, the client needs to send the server the variable names to subscribe to, which must be the names listed in the "Subscription Items" section below. Upon receiving the subscription request sent by the client, the server replies with a list of variable types. When the setup is complete, send the start signal and the server will start the synchronization cycle. When the synchronization cycle needs to be paused, send the pause signal.

After starting the synchronization cycle, the server will send data in the order requested by the client. If the value needs to be changed, the client will send the data after binary serialization according to the order of subscription.

All data packets have a uniform structure in the form of message header + message content (some data packets do not need message content). In the two steps of "Protocol Check" and "Setting", there is a reply message, but there is no reply message in the step of "Synchronization Cycle". Note that "Message Packets" can be sent and received at any time in all packets. The network port of the RTSI is 30004.

Instructions of RTSI, please visit the website: www.eliterobots.com.

15.4 Profinet Protocol

Profinet communication protocol is a new generation of automation bus standard based on industrial Ethernet technology. Data is transmitted through network cables. Profinet provides a complete network solution for the automation communication field, covering current hot topics in the automation field such as real-time Ethernet, motion control, distributed automation, fault safety and network safety.

15.4.1 Profinet Specification

1. Slot:

The PROFINET IO device has a total of 10 slots, and each slot corresponds to a module. A brief description of the 10 modules is as follows:

- R2P_State: Robot sends status data to PLC;
- R2P_IO: Robot sends IO data to PLC;
- R2P_Joints: Robot sends joint data to PLC;
- R2P_TCP: Robot sends TCP data to PLC;
- R2P_BIT_REG: Robot sends output boolean register data to PLC (0-63);
- R2P_INT_REG: Robot sends output integer register data to PLC (0-23);
- R2P_FLOAT_REG: Robot sends output float register data to PLC (0-23);
- P2R_IO: PLC sets robot IO;
- P2R_REG1: PLC sets the robot input register;
- P2R_REG2: PLC sets the robot input register.

Profinet sends and receives data in byte stream mode, so it defines A set of data format for each module. For the data format, please visit the website: www.eliterobots.com .

2. User defined data types:

For PLC S7-1200 and S7-1500 (PLC firmware 4.0 or later) : Elite_datastruct.udt (can be imported into TIA portal), please visit the website: www.eliterobots.com .

3. GSD file:

For GSDML-V1.00-ELITE-CS-20220620.xml (thumbnail: ELITE-ProfinetSlave.bmp), please visit the website: www.eliterobots.com .

15.5 Ethernet/IP Protocol

Ethernet/IP (Industrial Protocol) is an extended TCP/IP network protocol for real-time control that combined with the Common Industrial Protocol (CIP). It will better help the users to obtain more open, integrated industrial automation and information-based solution.

CS series products support the Ethernet/IP slave applications. Users do not need to reconfigure when the controller is used as the slave station. The communication between the master-slave stations is established through a RJ 45 twisted-pair cable. The master station will make a connection request and give the feedback of the connection status.

Please note that here the FB1 network port is used.

For more details, please visit the website: www.eliterobots.com.

15.6 30001 Communication Interface Protocol

15.6.1 Introduction

The controller is always providing data representing the robot's state, such as positions, temperatures. The data transmitted from each server socket. This port is "Primary Port" and it send data of robot's state.

15.6.2 Package Format

The protocol port is 30001, the frequency is 10HZ, and the package format is shown in Table 15-1.

Table 15-1 Package format

Bytes	Content
4	Length of whole package
1	Type of package = MESSAGE_TYPE_ROBOT_STATE = 16
4	Length of sub-package

1	Type of sub-package
n	Sub-package data
4	Length of sub-package
1	Type of sub-package
n	Sub-package data
.....	

Robot's state package includes package header, robot mode sub-package, joint sub-package, cartesian sub-package, robot configure sub-package, robot motherboard sub-package, robot additional information sub-package, robot tool data sub-package, robot safety mode sub-package, robot communication sub-package, and ELITE internal use sub-package. Detailed description of robot's state package and analysis example and description of 30001, please visit the website: www.eliterobots.com .

15.6.3 Script Control and Rules

1. Script Control

Port 30001 receives and executes the correct script.

2. Script Rules

* Scripts are classified into def script and sec script:

* def script, this script is the script generated when the task is running, can be called the main script, its running status is consistent with the task control button on the interface, when the def script is executing, if the new def script is received again, the previous def script will be stopped.

* sec script, this script can be executed at the same time as the def script, will not stop the current running def script, this script is mainly used to control IO state and other operations, can not run motion script.

* The script needs to start with "def script():\n" or "sec script():\n" and end with "\nend", where "script" is the script name and '\n' is the escape character, which defines an executable script. The contents of the script must conform to python's programming rules.

For example:

```
...
```

```
def HelloWorld():
```

```
    count = 0
```

```
    for i in range(10):
```

```
        count = i
```

```
        popup("Hello World %d" % count)
```

```
end
```

```
...
```

15.7 29999 Communication Interface Protocol

15.7.1 Introduction

EliRobot has enabled Dashboard functions: Connect to EliRobot 29999 port through TcpSocket and send commands to control EliRobot.

15.7.2 Connect EliRobot

To connect to the dashboard shell remotely, use the TcpSocket tool, telnet command line, and development code to bind the robot IP address and dashboard shell port 29999. As shown in Figure 15-12, the TcpSocket client is created.

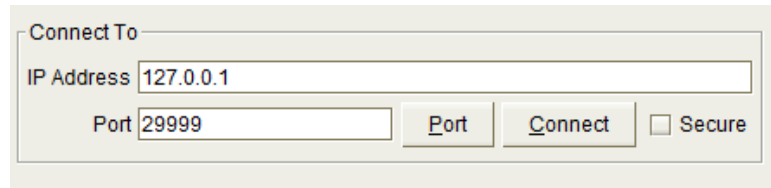

Figure 15-12 Connect to the EliRobot dashboard server

After the TcpSocket client is created and connected to the dashboard shell, the system receives the text shown in Figure 15-13, prompting the client or developer to run the help or usage command to query commands supported by the dashboard shell and their usage descriptions.

```
EliRobot dashboard shell, version 2.0.0.0.  
These shell commands are defined internally. Type `help` to see this list.  
Type `help name` to find out more about the function `name`.  
Type `usage name` to displays the usage for given command or all commands if none is specified.
```

Figure 15-13 EliRobot dashboard server connection succeeded

It should be noted that dashboard shell commands need to end input with "\n" by default. Therefore, when sending commands, end with "\n". Otherwise, the input will be considered incomplete and will not be responded to.

15.7.3 Dashboard Shell Commands

EliRobot dashboard shell provides a number of commands to interact with the EliRobot platform. Dashboard shell commands include basic commands and functional commands. The basic commands have a low correlation with the robot functions, while the functional commands have a high correlation with the robot functions. For a quick survey and detailed explanation of basic commands and functional commands, as well as common errors in using the dashboard shell, please visit the website: www.eliterobots.com.

Part IV Maintenance and Quality

16 Maintenance and Disposal

16.1 Maintenance

The maintenance and repair work must be implemented in strictly accordance with all safety instructions in this manual.

The maintenance, calibration and repair work must be operated in accordance with the latest service manual which can be found at: www.eliterobots.com . All dealers of Suzhou ELITE Robot Co., Ltd. can visit this website.

After changing the control system, the robot joints or the tool, the robot and the tool zero should be re-calibrated on the spot, and the calibration operation and the result judgment method are introduced in the specification of check for zero. In addition, the parameter settings should be checked. If the parameters are backed up, the backup parameters may be imported; if the parameters are not backed up, the parameters should be set again. If the robot joints or the tool needs to be replaced, the dynamics of the robot needs to be reentry.

Maintenance must be performed by an authorized system integrator, distributor, or ELITE ROBOT Co.,Ltd. When the parts are returned to ELITE ROBOT Co.,Ltd., disassembly and packaging should be performed in accordance with the instructions listed in the service manual.

The safety level stipulated by the maintenance and repair work must be ensured, the effective national or regional working safety regulations must be followed, and all safety functions run normally must be tested. The purpose of maintenance is to ensure the system operate properly. Repairment helps the robot to recover to normal state from system failure. Maintenance includes fault diagnosis and actual maintenance.

In order to avoid damage to the robot arm or the controller, the following safety procedure and cautions must be followed:

Safety procedure:

1. Unplug the main power cable from the back of the controller to ensure the robot is completely powered off. Take necessary precautions to prevent other persons from

re-energizing the system during the repair period. After all process are done, the user must double check the system again to ensure it has been completely powered down.

2. Please check the earth connection before re-starting the system.
3. Please comply with the electrostatic discharge (ESD) regulations when disassembling the robot arm or the controller.
4. Avoid disassembling the power supply system of the controller. The high voltage can be remained inside the power supply system for several hours after the controller is switched off.
5. Prevent water or dust from entering into the robot arm or the controller.

Cautions:

1. Replace faulty parts with the identical part number or the corresponding parts approved by ELITE ROBOT Co.,Ltd.
2. Reactivate all safety measures immediately upon completion of the work.
3. Record all maintenance operations in written form and save these records in the relevant technical documents for the whole robot system.
4. The controller cannot be repaired by end-users. If maintenance or repair services are needed, please contact the supplier or ELITE ROBOT Co.,Ltd

16.2 Disposal

The CS620 robot must be disposed of in accordance with the local and national laws, regulations, and standards

16.3 Maintenance

The safety function of the robot must be tested at least once a year to ensure function still proper.

17 Quality Assurance

17.1 Product Quality Assurance

Suzhou ELITE Robot Co., Ltd. should provide the necessary spare parts to replace or repair relevant parts if the new equipment and its components are defective resulting from manufacturing and/or poor materials.

Suzhou ELITE Robot Co., Ltd. shall possess the ownership of the equipment or components replaced or returned to ELITE ROBOT Co.,Ltd.

If the product is no longer under warranty, Suzhou ELITE Robot Co., Ltd. shall reserve the right of charging the customer for replacement or repair.

In case of defects of equipment that is out of warranty, Suzhou ELITE Robot Co., Ltd. shall not be responsible for any damage or loss caused therefrom, such as loss of production or damage due to other production equipment.

17.2 Disclaimer

If the equipment defect is caused by improper disposal or failing to comply with the relevant information stated in the user manual, the "Product Quality Assurance" will be invalid.

The warranty shall not cover the failure caused by the following circumstances:

1. Mounting, wiring and connection to other control equipment are not in line with the industrial standards or not implemented in accordance with the requirements of the user manual.

2. When the CS620 is used outside the specification or standards shown in this user manual.

3. This product is applied to the non-designated purposes.

4. The storage mode and operating environment are outside the specified scope (such as pollution, salt damage and dewing) of the user manual.

5. The product is damaged as a result of improper transportation.
6. Damage due to accident or impact.
7. When non-original parts and accessories are installed.
8. Damage as a result of modification, debugging or repair of the original parts by the third party outside ELITE ROBOT Co.,Ltd.
9. Natural disasters, such as fire, earthquake, tsunamis, lightning strikes, wind and flood.
10. Failure outside the above mentioned circumstances and not caused by ELITE ROBOT Co.,Ltd.

The following circumstances will not be covered by warranty:

1. The date of production or the start date of the warranty cannot be identified.
2. Alteration of the software or internal data.
3. The failure cannot be reproduced, or ELITE ROBOT Co.,Ltd. cannot identify the failure.
4. This product is used near or around radioactive equipment, biological test equipment, or in environments deemed hazardous by ELITE ROBOT Co.,Ltd.

In accordance with the product quality assurance agreement, ELITE ROBOT Co.,Ltd. shall be responsible for making the commitment of quality guarantee for the defects or deficiencies occurring in the products and parts sold to the dealers.

As for any other explicit or implied warranties or liabilities including, but not limited to, any implied warranty for marketability or specific use, ELITE ROBOT Co.,Ltd. shall not bear the related liability to guarantee.

In addition, ELITE ROBOT Co.,Ltd. shall not be responsible for the related liabilities in allusion to any form of indirect damage or consequence generated by the related product.

Part V Appendix

I Glossaries

Stop Category 0 [Cat.0 Stop]: Stopping by immediate removal of power to the machine actuators. (in accordance with IEC 60204-1:2018, 9.2.2)

Stop Category 1 [Cat.1 Stop]: A controlled stop with power available to the machine actuators to achieve the stop and then removal of power when the stop is achieved. [in accordance with IEC 60204-1:2018, 9.2.2]

Stop Category 2 [Cat.2 Stop]: A controlled stop with power remaining available to the machine actuators. [in accordance with IEC 60204-1:2018, 9.2.2]

Performance Level [PL]: Discrete level used to specify the ability of safety-related parts of control systems to perform a safety function under foreseeable conditions. [in accordance with ISO 13849-1:2015, 3.1.23]

Enabling Device: Additional manually operated device used in conjunction with a start control and which, when continuously actuated, allows a machine to function. [in accordance with ISO 12100:2010, 3.28.2]

Risk Assessment: Overall process comprising a risk estimation, hazard identification and judgement of whether the risk reduction objectives have been achieved. [in accordance with ISO 12100:2010, 3.15, 3.16, 3.17]

II Technical Specifications

Table II-1 Technical specifications

Robotic Arm	Payload		20 kg
	Working radius		1800 mm
	Pose repeatability		± 0.1 mm
	Degrees of freedom		6
	Joints range		$\pm 360^\circ$
	Maximum joint speed	Joint 1	125°/s
		Joint 2	125°/s
		Joint 3	150°/s
		Joint 4	210°/s
		Joint 5	210°/s
		Joint 6	210°/s
	Max. TCP speed		3.9 m/s
	IP rating		IP68
	ISO 14644-1 class cleanroom		5
	Ambient temperature		-10-50°C
	Relative humidity		90% RH (No Condensation)
	Typical power consumption		625 w
	Mounting		Any angle
	Tool I/O		4 x DO/4 x DI (configurable), 1 x AI, 1x AO
	Tool I/O power supply		Aviation socket 1, 12 V / 24 V, 3 A (three pin mode), 2 A (dual pin mode), 1 A (single pin mode); Aviation socket 2, 24 V, 5 A
Tool communication		RS485, CAN (reserved)	
Footprint		\varnothing 240 mm	
Weight		60 kg	
Material		Aluminum alloy, plastic, steel, rubber	
Cable length		5.5 m	

Controller ERB1C4k0	Cabinet size (W x H x L)	505mm x 462mm x 257mm
	Weight	16 kg
	Material	Aluminum alloy, steel
	IP rating	IP44
	I/O interface	24 x DI (8 x DI Configurable), 24 x DO (8 x DO configurable), 2 x AI, 2 x AO, 4 x high speed digital input
	I/O power supply	Voltage: 24V; Current: 3A (internal power), 6A (external power)
	Communication	3 Ethernet, 1 RS485, TCP/IP, MODBUS, TCP/RTU, EtherNet/IP, Profinet
	Power supply	100-240 VAC, 50-60 Hz
	Ambient temperature	-10-50°C
	Relative humidity	90% RH (No Condensation)
Teach Pendant	Screen display size	12.1"
	Resolution	1280 x 800 pixels
	Material	Aluminum alloy, plastic, rubber
	Weight	1.7 kg
	Cable length	5.5 m
	IP rating	IP54
	Ambient temperature	-10-50°C
	Relative humidity	90% RH (No Condensation)

III Application Standard

The design of the CS620 cooperative robot refers to the following standards, as shown in the table below:

Table III-1 Robot application standard

Standard	Definition
ISO 12100:2010	Safety of machinery: General principles of design- Risk assessment and risk reduction
ISO 10218-1:2011	Robots and robotic devices - Safety requirements for industrial robots
IEC 60204-1: 2018	Safety of machinery - Electrical equipment of machines
ISO/TS 15066:2016	Safety requirements for collaborative industrial robot Robots and robotic devices —Collaborative robots
ISO 13849-1:2015	Safety of machinery: Safety-related parts of control systems - Part 1: General principles of design
ISO 13849-2:2015	Safety of machinery: Safety-related parts of control systems - Part 2: Validation
ISO 13850:2015	Safety of machinery: Emergency stop - Principles for design
IEC 62061: 2015	Safety of machinery: Functional safety of safety-related electrical, electronic and programmable electronic control systems
IEC 61508 series	Functional safety of electrical / electronic / programmable electronic safety-related systems
IEC 61800-5-2: 2016	Adjustable speed electrical power drive systems – Part 5-2: Safety requirements - Functional
IEC 61784-3: 2017	Communication networks - Profiles - Part3: Functional safety fieldbuses - General rules and profile definitions
IEC 61000-6-4: 2019	Electromagnetic compatibility - Part 6-2: Generic standards – Emission standard for industrial

	environments
IEC 61000-6-2: 2019	Electromagnetic compatibility - Part 6-2: Generic standards – Immunity standard for industrial environments
ANSI/UL 1740, 4 Ed., Rev. June 20, 2019	Standard for safety – Robots and robotic equipmen
ANSI/RIA R15.06-2012, Dated March 28, 2013	For industrial robots and robot systems – Safety Requirements
CAN/CSA Z434-14 (R2019), Reaffirmed 2019	Industrial robots and robot systems
CAN/CSA C22.2 No. 14-18	Industrial control equipment
NFPA 79, 2018 Edition, 2018	Electrical standard for industrial machinery

IV Certificate



VERIFICATION OF MD COMPLIANCE

No.:	MD SHES2304007105MD
Applicant:	Suzhou Elite Robot Co., Ltd. 1F, Building 4, No 259 Changyang Street, Industrial Park, Suzhou, China
Manufacturer:	Suzhou Elite Robot Co., Ltd. 1F, Building 4, No 259 Changyang Street, Industrial Park, Suzhou, China
Product Description:	Collaborative Robot
Model No.:	CS63, CS66, CS612, CS620, CS625
Trade Mark:	 ELITE ROBOTS 艾利特机器人
Additional Information (if any):	--
Sufficient samples of the product have been tested and found to be in conformity with	
Test Standard:	EN ISO 10218-1:2011 EN 60204-1:2018 EN ISO 13849-1:2015 EN ISO 12100:2010
as shown in the	SHES230400710501-01/02/03
Test Report Number(s):	SHFS230500018471

This Verification of MD Compliance has been granted to the applicant based on the results of tests, performed by Laboratory of SGS-CSTC Standards Technical Services Co., Ltd. on sample of the above-mentioned product in accordance with the provisions of the relevant harmonized standards under the Machinery Directive 2006/42/EC. The CE mark as shown below can be affixed, under the responsibility of the manufacturer, after completion of an EC Declaration of Conformity and compliance with all relevant EC Directives. The affixing of the CE marking presumes in addition that the conditions in the Directives are fulfilled.



Andrew Zhai
Technical Manager
SGS-CSTC

2023-06-09



Copyright of this verification is owned by SGS-CSTC Standards Technical Services Co., Ltd. and may not be reproduced other than in full and with the prior approval of the General Manager. This verification is subjected to the governance of the General Conditions of Services which can be accessible at <https://www.sgs.com/en/terms-and-conditions>.

Member of SGS Group (Société Générale de Surveillance)

Safety-VOC-F02/ Rev.1.0/ 2021-11-29
Page 1 of 1

Figure IV-1 CE mark MD directive certificate



**SGS-CSTC Standards Technical Services
Co., Ltd.**

VERIFICATION OF COMPLIANCE

Verification No.: SHEM230400226301MDC
Applicant: Suzhou Elite Robot Co.,Ltd.
Address of Applicant: 1F, Building 4, No 259 Changyang Street, Suzhou Industrial Park Suzhou,
Jiangsu Province, 215000, China
Product Description: Collaborative Robot
Model No.: CS63, CS66, CS612, CS620, CS625
Sufficient samples of the product have been tested and found to be in conformity with
Test Standards: EN IEC 61000-6-4: 2019
EN IEC 61000-6-2: 2019
As shown in the
Test Report Number(s): SHEM230400226301

This verification of EMC Compliance has been granted to the applicant based on the results of the tests, performed by laboratory of SGS-CSTC Standards Technical Services Co., Ltd. on the sample of the above-mentioned product in accordance with the provisions of the relevant specific standards under Directive 2014/30/EU. The CE mark as shown below can be used under the responsibility of the manufacturer, after completion of an EU Declaration of Conformity and compliance with all relevant EU Directives.

Parlam Zhan

Parlam Zhan
Laboratory Manager



Date: 2023-04-28

Copyright of this verification is owned by SGS-CSTC Standards Technical Services Co., Ltd. and may not be reproduced other than in full and with the prior approval of the General Manager. This verification is subjected to the governance of the General Conditions of Services which can be accessed at <https://www.sgs.com/en/terms-and-conditions>.

Member of SGS Group (Société Générale de Surveillance)

Page 1 of 1

Figure IV-2 CE mark EMC directive certificate

CERTIFICATE



Functional Safety

Certificate No. SHFS2305000184MD ISSUE 1

Certificate Holder:	Suzhou Elite Robot Co., Ltd. 1F, Building 4, No 259 Changyang Street, Suzhou Industrial Park, Suzhou, Jiangsu Province, China
Manufacturer:	Same as Certificate Holder
Trademarks:	 ELITE ROBOTS 艾利特机器人
Certified Product:	CS series collaborative robot system
Model (s) No. / Series:	CS63, CS66, CS612, CS620, CS625
Assessment Performed:	ISO 13849-1: 2015
Conclusion:	The safety architecture and performance level meet PL d with category 3 according to ISO 13849-1: 2015, detail information of safety functions is shown in Appendix.
Additional Information:	Safety functions of CS series collaborative robot safety system were defined in ISO 10218-1:2011.

As shown in the technical report number(s): SHFS230500018471

This certificate confirms the achievement of the requirements of functional safety based on proof of the safety-related parameters (failure rate, DC / SFF, safety architecture etc), proofs that processes, and methods are established at the manufacturer guaranteeing that unexceptionable processes in terms of risk analysis, design, production, validation, modification and quality management comply with the standard.

Authorized by:

Issued Date: 18th May. 2023

Andrew Zhai
Certifier

Expired Date: 18th May. 2028

This certificate is issued by the company under its General Conditions for Certification Services accessible at <https://www.sgs.com/en/terms-and-conditions>. Attention is drawn to the limitations of liability defined therein and in the Test Report here above mentioned which findings are reflected in this Certificate. Any unauthorized alteration, forgery or falsification of the content or appearance of this document is unlawful and offenders may be prosecuted to the fullest extent of the law.

Certification Body
SGS-CSTC Standards Technical Services Co., Ltd.
16/F, Century Yuhui Mansion, No.73 Fucheng Road, Beijing China 100036
Tel: (86-10)6845 669



APPENDIX

Supplementary of Functional Safety Certificate

Certificate No. SHFS2305000184MD ISSUE 1

Summary of Safety Functions:

SF	Item & Description	PL	Response Time	Maximum Stop Degree	Safe State
SF1	Emergency Stop	PL d	120ms	4.5°	Cat. 1 Stop
SF2	External Emergency Stop	PL d	120ms	4.5°	Cat. 1 Stop
SF3	Safeguard Stop	PL d	350ms	10.5°	Cat. 2 Stop
SF4	Safeguard Reset	PL d	140ms	3.5°	Cat. 0 Stop
SF5	Automatic Mode Safeguard Stop	PL d	350ms	10.5°	Cat. 2 Stop
SF6	Automatic Mode Safeguard Reset	PL d	140ms	3.5°	Cat. 0 Stop
SF7	3 Position Enabling Device Input	PL d	350ms	10.5°	Cat. 2 Stop
SF8	Emergency Stop Output	PL d	10ms	N/A	Low-Level Output

Figure IV-3 Functional Safety Certificate

V Alarm Information

Table V-1 CS program alarm information

Alarm #	Description	Possible Reasons	Suggested Treatment
E1S0	Communication Alarm		
E1S1	Tool communication failure	Unable to communicate with the tool.	Try the following in turn: (1) Power off and restart the robot. (2) Contact ELITE ROBOTS after-sales service for assistance.
E1S2	[Slave] {joint} joint communication failure	Unable to communicate with the joint.	Try the following in turn: (1) Power off and restart the robot. (2) Contact ELITE ROBOTS after-sales service for assistance.
E1S3	{joint} joint communication failure	Unable to communicate with the joint.	Try the following in turn: (1) Power off and restart the robot. (2) Contact ELITE ROBOTS after-sales service for assistance.
E1S4	Robot communication failure	Unable to communicate with the robot.	Try the following in turn: (1) Power off and restart the robot. (2) Contact ELITE ROBOTS after-sales service for assistance.
E2S0	Emergency Stop Alarm		
E2S1	Robot emergency stop	Emergency stop button pressed.	Try the following in turn: (1) Release the emergency stop button. (2) Restart the robot.
E2S2	System emergency stop	Emergency stop IO is triggered.	Try the following in turn: (1) Check whether the Emergency Stop function of the safety input IO is configured correctly and release the trigger state. (2) Check whether the emergency stop IO trigger state of the masterboard is

			correct and release the trigger state. (3) Contact ELITE ROBOTS after-sales service for assistance.
E3S0	Calibration Alarm		
E3S1	Robot calibration failed, error: {float} exceeded maximum limit: 5	The accuracy error of calibration point is too large.	Try the following in turn: (1) Reset the calibration point to ensure the accuracy and the diversity of position. (2) Contact ELITE ROBOTS after-sales service for assistance.
E3S3	Tool calibration failed	The accuracy of tool calibration points is poor or the position is similar.	Try the following in turn: (1) Reset the calibration point to ensure the accuracy and the diversity of position. (2) Contact ELITE ROBOTS after-sales service for assistance.
E3S4	Robot joint zero position lost	The robot has not been calibrated.	Try the following in turn: (1) Calibrate the robot with 'Joint Zeroing' in expert mode. (2) Contact ELITE ROBOTS after-sales service for assistance.
E3S5	Robot calibration failed	An error occurred during robot calibration.	Try the following in turn: (1) Make sure that the calibration process is correct. (2) Contact ELITE ROBOTS after-sales service for assistance.
E3S6	Current robot structure does not support calibration	The current robot structure type is incorrect.	Try the following in turn: (1) Make sure that the robot structure type is correct. (2) Update the controller software. (3) Contact ELITE ROBOTS after-sales service for assistance.
E3S7	Insufficient number of calibration reference points	There are less than 20 calibration points.	Try the following in turn: (1) Increase the number of calibration points to 20.

V Alarm Information

			(2) Contact ELITE ROBOTS after-sales service for assistance.
E4S0	Brake Release Alarm		
E4S1	Robot can't release the brakes	Fail to release the brakes.	Try the following in turn: (1) Power off and restart the robot. (2) Contact ELITE ROBOTS after-sales service for assistance.
E6S0	Safety System Alarm		
E6S1	{joint} is close to joint soft limit	Joint position is close to joint soft limit.	Try the following in turn: (1) Check whether the robot position and the joint soft limit parameters are correct. (2) Contact ELITE ROBOTS after-sales service for assistance.
E6S2	{joint} exceeds joint soft limit	Joint position exceeds joint soft limit.	Try the following in turn: (1) Check whether the robot position and the joint soft limit parameters are correct. (2) Contact ELITE ROBOTS after-sales service for assistance.
E6S3	Close to safety plane	Tool position close to safety plane.	Try the following in turn: (1) Check whether the robot position, TCP and safety plane parameters are correct to ensure that the robot TCP position does not close to the safety plane. (2) Contact ELITE ROBOTS after-sales service for assistance.
E6S4	Exceeds the safety plane	Tool position exceeds safety plane.	Try the following in turn: (1) Check whether the robot position, TCP and safety plane parameters are correct to ensure that the robot TCP position does not exceed the safety plane. (2) Contact ELITE ROBOTS after-sales

			service for assistance.
E6S5	Close to safety plane	Elbow position close to safety plane.	<p>Try the following in turn:</p> <p>(1) Check whether the robot position and safety plane parameters are correct to ensure that the robot elbow position does not close to safety plane.</p> <p>(2) Contact ELITE ROBOTS after-sales service for assistance.</p>
E6S6	Exceeds the safety plane	Elbow position exceeds safety plane.	<p>Try the following in turn:</p> <p>(1) Check whether the robot position and safety plane parameters are correct to ensure that the robot elbow position does not exceed the safety plane.</p> <p>(2) Contact ELITE ROBOTS after-sales service for assistance.</p>
E6S7	Base joint speed ($\{\text{float}\}^\circ/\text{s}$) is too fast	Base joint speed exceeds safety speed limits.	<p>Try the following in turn:</p> <p>(1) Check whether the robot running state is correct to ensure that the joint speed does not exceed the safety limit.</p> <p>(2) Contact ELITE ROBOTS after-sales service for assistance.</p>
E6S8	Shoulder joint speed ($\{\text{float}\}^\circ/\text{s}$) is too fast	Shoulder joint speed exceeds safety speed limits.	<p>Try the following in turn:</p> <p>(1) Check whether the robot running state is correct to ensure that the joint speed does not exceed the safety limit.</p> <p>(2) Contact ELITE ROBOTS after-sales service for assistance.</p>
E6S9	Elbow joint speed ($\{\text{float}\}^\circ/\text{s}$) is too fast	Elbow joint speed exceeds safety speed limits.	<p>Try the following in turn:</p> <p>(1) Check whether the robot running state is correct to ensure that the joint speed does not exceed the safety limit.</p> <p>(2) Contact ELITE ROBOTS after-sales service for assistance.</p>
E6S10	Wrist1 joint speed ($\{\text{float}\}^\circ/\text{s}$) is too fast	Wrist1 joint speed exceeds safety speed	<p>Try the following in turn:</p> <p>(1) Check whether the robot running</p>

V Alarm Information

		limits.	state is correct to ensure that the joint speed does not exceed the safety limit. (2) Contact ELITE ROBOTS after-sales service for assistance.
E6S11	Wrist2 joint speed ($\{\text{float}\}^\circ/\text{s}$) is too fast	Wrist2 joint speed exceeds safety speed limits.	Try the following in turn: (1) Check whether the robot running state is correct to ensure that the joint speed does not exceed the safety limit. (2) Contact ELITE ROBOTS after-sales service for assistance.
E6S12	Wrist3 joint speed ($\{\text{float}\}^\circ/\text{s}$) is too fast	Wrist3 joint speed exceeds safety speed limits.	Try the following in turn: (1) Check whether the robot running state is correct to ensure that the joint speed does not exceed the safety limit. (2) Contact ELITE ROBOTS after-sales service for assistance.
E6S13	Tool speed ($\{\text{float}\}$ mm/s) is too fast	Tool speed exceeds safety speed limits.	Try the following in turn: (1) Check whether the robot running state is correct to ensure that the tool speed does not exceed the safety limit. (2) Contact ELITE ROBOTS after-sales service for assistance.
E6S14	Elbow speed ($\{\text{float}\}$ mm/s) is too fast	Elbow speed exceeds safety speed limits.	Try the following in turn: (1) Check whether the robot running state is correct to ensure that the elbow speed does not exceed the safety limit. (2) Contact ELITE ROBOTS after-sales service for assistance.
E6S16	{joint} position limit violated	The joint target position is too different from the actual position.	Try the following in turn: (1) Check whether the robot running state, robot payload and speed parameters are correct. (2) Contact ELITE ROBOTS after-sales service for assistance.
E6S17	The controller will	The robot safety mode	Try the following in turn:

	enter the RECOVERY mode	is in a violation state. The safety parameters restrictions will no longer take effect. Please ensure safety when using the robot.	(1) Operate the robot to a safe position. (2) Contact ELITE ROBOTS after-sales service for assistance.
E6S18	The reduced mode safety IO input signal is inconsistent	Safety IO input signal is inconsistent.	Try the following in turn: (1) Please ensure that the safety IO connection is correct and the signal is switched at the same time. (2) Contact ELITE ROBOTS after-sales service for assistance.
E6S19	The emergency stop safety IO input signal is inconsistent	Safety IO input signal is inconsistent.	Try the following in turn: (1) Please ensure that the safety IO connection is correct and the signal is switched at the same time. (2) Contact ELITE ROBOTS after-sales service for assistance.
E6S20	The operational mode safety IO input signal is inconsistent	Safety IO input signal is inconsistent.	Try the following in turn: (1) Please ensure that the safety IO connection is correct and the signal is switched at the same time. (2) Contact ELITE ROBOTS after-sales service for assistance.
E6S21	The auto mode safeguard stop safety IO input signal is inconsistent	Safety IO input signal is inconsistent.	Try the following in turn: (1) Please ensure that the safety IO connection is correct and the signal is switched at the same time. (2) Contact ELITE ROBOTS after-sales service for assistance.
E6S22	The auto mode safeguard stop reset safety IO input signal is inconsistent	Safety IO input signal is inconsistent.	Try the following in turn: (1) Please ensure that the safety IO connection is correct and the signal is switched at the same time. (2) Contact ELITE ROBOTS after-sales

V Alarm Information

			service for assistance.
E6S23	The safeguard stop reset safety IO input signal is inconsistent	Safety IO input signal is inconsistent.	Try the following in turn: (1) Please ensure that the safety IO connection is correct and the signal is switched at the same time. (2) Contact ELITE ROBOTS after-sales service for assistance.
E6S24	The three position enabling safety IO input signal is inconsistent	Safety IO input signal is inconsistent.	Try the following in turn: (1) Please ensure that the safety IO connection is correct and the signal is switched at the same time. (2) Contact ELITE ROBOTS after-sales service for assistance.
E6S25	The masterboard emergency stop safety IO input signal is inconsistent	Safety IO input signal is inconsistent.	Try the following in turn: (1) Please ensure that the safety IO connection is correct and the signal is switched at the same time. (2) Contact ELITE ROBOTS after-sales service for assistance.
E6S26	The masterboard safeguard stop safety IO input signal is inconsistent	Safety IO input signal is inconsistent.	Try the following in turn: (1) Please ensure that the safety IO connection is correct and the signal is switched at the same time. (2) Contact ELITE ROBOTS after-sales service for assistance.
E6S27	The Teach Pendant emergency stop IO input signal is inconsistent		Try the following in turn: (1) Please check if the Emergency Stop button state is correct. (2) Contact ELITE ROBOTS after-sales service for assistance.
E6S30	Tool force is beyond max limit	The force of the robot tool exceeds the safety limit.	Try the following in turn: (1) Check the safety of the robot operation space to ensure that there is no collision. (2) Check whether the robot tool force

			<p>limit setting is correct.</p> <p>(3) Contact ELITE ROBOTS after-sales service for assistance.</p>
E6S31	Elbow force is beyond max limit	The force of the robot elbow exceeds the safety limit.	<p>Try the following in turn:</p> <p>(1) Check the safety of the robot operation space to ensure that there is no collision.</p> <p>(2) Check whether the robot elbow force limit setting is correct.</p> <p>(3) Contact ELITE ROBOTS after-sales service for assistance.</p>
E6S32	Robot's power on environment is over max limit	The power of the robot to the environment exceeds the safety limit.	<p>Try the following in turn:</p> <p>(1) Check the safety of the robot operation space to ensure that there is no collision.</p> <p>(2) Check whether the robot power limit setting is correct.</p> <p>(3) Contact ELITE ROBOTS after-sales service for assistance.</p>
E6S33	Robot's momentum is over max limit	The momentum of the robot exceeds the safety limit.	<p>Try the following in turn:</p> <p>(1) Check the safety of the robot operation space to ensure that there is no collision.</p> <p>(2) Check whether the robot momentum limit setting is correct.</p> <p>(3) Contact ELITE ROBOTS after-sales service for assistance.</p>
E6S34	The robot consumes too much power	The robot moves in Cartesian space near the singularity zone.	<p>Try the following in turn:</p> <p>(1) Use joint movement to move the robot away from singularity zone.</p> <p>(2) Reduce the robot's movement speed.</p> <p>(3) Contact ELITE ROBOTS after-sales service for assistance.</p>
E6S40	Fail to turn on the robot 48v power	Robot 48v power can't be controlled.	<p>Try the following in turn:</p> <p>(1) Please turn on and off the 48v power</p>

V Alarm Information

			again. (2) Contact ELITE ROBOTS after-sales service for assistance.
E6S41	Fail to turn off the robot 48v power	Robot 48v power can't be controlled.	Try the following in turn: (1) Please turn on and off the 48v power again. (2) Contact ELITE ROBOTS after-sales service for assistance.
E6S42	Robot is disconnect	Robot is disconnect.	Try the following in turn: (1) Please check whether the robot connection is correct, and then power on the robot again. (2) Contact ELITE ROBOTS after-sales service for assistance.
E6S43	{joint} serial number binding check failed	<ol style="list-style-type: none"> 1. The controller is not bound to the robot. 2. The robot connected to the controller is not its bound robot. 3. The robot has replaced joint hardware. 	Try the following in turn: (1) Contact ELITE ROBOTS after-sales service for assistance.
E6S44	Tool IO serial number binding check failed	<ol style="list-style-type: none"> 1. The controller is not bound to the robot. 2. The robot connected to the controller is not its bound robot. 3. The robot has replaced joint hardware. 	Try the following in turn: (1) Contact ELITE ROBOTS after-sales service for assistance.
E6S45	No dynamic data of robot joints. Error Info:{string}	<ol style="list-style-type: none"> 1. The joint is not subject to dynamic identification or identification data is not written. 2. Joint data is corrupt. 	Try the following in turn: (1) Contact ELITE ROBOTS after-sales service for assistance.
E6S46	For the initial	1. Dynamic data is	Try the following in turn:

	configuration of dynamics data, please restart the robot to complete the configuration	configured for the first time.	(1) Power off and restart the controller. (2) Contact ELITE ROBOTS after-sales service for assistance.
E6S47	{joint} dynamics data does not match the configuration file	1. The robot connected to the controller is not its bound robot. 2. Joint internal data or configuration file data is corrupt. 3. The robot has replaced joint hardware.	Try the following in turn: (1) Contact ELITE ROBOTS after-sales service for assistance.
E6S50	{joint}' encoder calibration failed	Joint encoder auto-calibration failed.	Try the following in turn: (1) Power off and restart the robot. (2) Contact ELITE ROBOTS after-sales service for assistance.
E6S100	Safety Board Alarm: {string}	Safety board is in violation state.	Try the following in turn: (1) Please try to reset the state of safety functions (such as safety IO, SG Stop, etc.). (2) Contact ELITE ROBOTS after-sales service for assistance.
E7S0	Dynamics Alarm		
E7S1	Dynamics initialization failed	The current robot type is incorrect.	Try the following in turn: (1) Power off and restart the controller. (2) Update the controller software and servo firmware. (3) Contact ELITE ROBOTS after-sales service for assistance.
E7S2	Robot is not in RUNNING mode, hand drag mode started failed	The robot's brakes are engaged.	Try the following in turn: (1) Please check the status of the robot, then power on the robot and release the brakes. (2) Contact ELITE ROBOTS after-sales

V Alarm Information

			service for assistance.
E7S3	The robot mounting verification failed	The actual mounting of the robot is inconsistent with the configuration.	<p>Try the following in turn:</p> <ol style="list-style-type: none"> (1) Please set the correct robot mounting in configuration. (2) Contact ELITE ROBOTS after-sales service for assistance.
E7S5	Unknown robot structure type	The current robot structure type is incorrect.	<p>Try the following in turn:</p> <ol style="list-style-type: none"> (1) Power off and restart the controller. (2) Update the controller software and servo firmware. (3) Contact ELITE ROBOTS after-sales service for assistance.
E7S6	Unknown robot type	The current robot type is incorrect.	<p>Try the following in turn:</p> <ol style="list-style-type: none"> (1) Power off and restart the controller. (2) Update the controller software and servo firmware. (3) Contact ELITE ROBOTS after-sales service for assistance.
E7S7	Failed to enable dynamic function	The dynamic function is disabled since dynamic model check failed.	<p>Try the following in turn:</p> <ol style="list-style-type: none"> (1) Power on again and release the brake, avoiding external force on robot. (2) Check if payload, mounting, zero position and dh parameters are correct. (3) Restart the robot after clearing the alarm. (4) Contact ELITE ROBOTS after-sales service for assistance.
E7S8	Failed to start hand drag mode	The dynamic function is disabled since dynamic model check failed.	<p>Try the following in turn:</p> <ol style="list-style-type: none"> (1) Restart drag mode and avoid applying a force on robot before dragging. (2) Check if payload, mounting, zero position and dh parameters are correct. (3) Restart the robot after clearing the alarm. (4) Contact ELITE ROBOTS after-sales

			service for assistance.
E7S9	Startup stage of hand drag mode is abnormal	The joint speed of drag startup stage is too fast.	<p>Try the following in turn:</p> <p>(1) Restart drag mode and avoid driving robot too fast at the moment of dragging start.</p> <p>(2) Check if payload, mounting, zero position and dh parameters are correct.</p> <p>(3) Restart the robot after clearing the alarm.</p> <p>(4) Contact ELITE ROBOTS after-sales service for assistance.</p>
E7S10	Startup stage of hand drag mode is abnormal	The joint torque of drag startup stage is abnormal.	<p>Try the following in turn:</p> <p>(1) Restart drag mode and avoid applying a force on robot before dragging.</p> <p>(2) Check if payload, mounting, zero position and dh parameters are correct.</p> <p>(3) Restart the robot after clearing the alarm.</p> <p>(4) Contact ELITE ROBOTS after-sales service for assistance.</p>
E8S0	Record Path Alarm		
E8S1	Failed to record path	The recorded path is too short.	<p>Try the following in turn:</p> <p>(1) Please extend the recorded short.</p>
E9S0	Teach Pendant Alarm		
E9S1	Teach pendant disconnected	<ol style="list-style-type: none"> 1. The teach pendant is pulled out. 2. The teach pendant communication is unstable. 3. The teaching pendant cable is damaged. 	<p>Try the following in turn:</p> <p>(1) Replug the teach pendant.</p> <p>(2) Check whether the teach pendant cable is connected normally.</p> <p>(3) Contact ELITE ROBOTS after-sales service for assistance.</p>
E9S2	Teach pendant is in alarm, alarm code: {signed}		<p>Try the following in turn:</p> <p>(1) Re plug the teach pendant.</p> <p>(2) Contact ELITE ROBOTS after-sales</p>

V Alarm Information

			service for assistance.
E9S3	The current safety hardware config prohibits connecting to the teach pendant	The current safety hardware config is set to NO TEACH PENDANT mode, but a teach pendant is connected.	Try the following in turn: (1) Disconnect the teach pendant. (2) Set the teaching pendant type in the safety hardware config to STANDARD type. (3) Contact ELITE ROBOTS after-sales service for assistance.
E10S0	File System Alarm		
E10S1	Cannot delete file	The file does not exist or is occupied.	Try the following in turn: (1) Power off and restart the controller. (2) Update the controller software. (3) Contact ELITE ROBOTS after-sales service for assistance.
E10S2	Failed to open file {string}	The file does not exist or is corrupt.	Try the following in turn: (1) Please check the validity of the file. (2) Power off and restart the controller. (3) Contact ELITE ROBOTS after-sales service for assistance.
E11S0	Memory Alarm		
E11S1	Failed to allocate memory	An error occurred in controller software.	Try the following in turn: (1) Power off and restart the controller. (2) Update the controller software. (3) Contact ELITE ROBOTS after-sales service for assistance.
E11S2	Wrong memory pointer is freed: {hex}	An error occurred in controller software.	Try the following in turn: (1) Power off and restart the controller. (2) Update the controller software. (3) Contact ELITE ROBOTS after-sales service for assistance.
E11S3	Pointer with value zero is freed: {hex}	An error occurred in controller software.	Try the following in turn: (1) Power off and restart the controller. (2) Update the controller software. (3) Contact ELITE ROBOTS after-sales service for assistance.

E11S4	The pointer value is 0	An error occurred in controller software.	Try the following in turn: (1) Power off and restart the controller. (2) Update the controller software. (3) Contact ELITE ROBOTS after-sales service for assistance.
E12S0	Servo Alarm		
E12S1	Servo alarm: [[string]]		Try the following in turn: (1) Power off and restart the robot. (2) Update the controller software and servo firmware. (3) Contact ELITE ROBOTS after-sales service for assistance.
E12S10	{joint} overcurrent	The joint detects overcurrent.	Try the following in turn: (1) Power off and restart the robot. (2) Update the controller software and servo firmware. (3) Contact ELITE ROBOTS after-sales service for assistance.
E12S20	{joint} Abnormal zero position of joint current	<ol style="list-style-type: none"> 1. Incorrect setting of payload and acceleration parameters. 2. The payload is too large and exceeds the load characteristic curve. 3. Mechanical jamming caused by impact, joint brake not opened, etc. 4. The hardware of the joint driver is damaged. 	Try the following in turn: (1) Power off and restart the robot after clearing the alarm. (2) Check whether the payload and acceleration parameters are set correctly. (3) Check whether the payload is too large and exceeds the load characteristic curve in user manual. (4) Contact ELITE ROBOTS after-sales service for assistance.
E12S21	{joint} Joint driver overcurrent	<ol style="list-style-type: none"> 1. Incorrect setting of payload and acceleration parameters. 2. The payload is too large and exceeds the 	Try the following in turn: (1) Power off and restart the robot after clearing the alarm. (2) Check whether the payload and acceleration parameters are set

V Alarm Information

		<p>load characteristic curve.</p> <p>3. Mechanical jamming caused by impact, joint brake not opened, etc.</p> <p>4. The hardware of the joint driver is damaged.</p>	<p>correctly.</p> <p>(3) Check whether the payload is too large and exceeds the load characteristic curve in user manual.</p> <p>(4) Contact ELITE ROBOTS after-sales service for assistance.</p>
E12S24	{joint} Joint motor overcurrent	<p>1. Incorrect setting of payload and acceleration parameters.</p> <p>2. The payload is too large and exceeds the load characteristic curve.</p> <p>3. Mechanical jamming caused by impact, joint brake not opened, etc.</p> <p>4. The hardware of the joint driver is damaged.</p>	<p>Try the following in turn:</p> <p>(1) Power off and restart the robot after clearing the alarm.</p> <p>(2) Check whether the payload and acceleration parameters are set correctly.</p> <p>(3) Check whether the payload is too large and exceeds the load characteristic curve in user manual.</p> <p>(4) Contact ELITE ROBOTS after-sales service for assistance.</p>
E12S30	{joint} The deviation between the actual joint and the target position is too large	<p>1. Incorrect setting of payload and acceleration parameters.</p> <p>2. The payload is too large and exceeds the load characteristic curve.</p> <p>3. Mechanical jamming caused by impact, joint brake not opened, etc.</p> <p>4. The hardware of the joint driver is damaged.</p>	<p>Try the following in turn:</p> <p>(1) Power off and restart the robot after clearing the alarm.</p> <p>(2) Check whether the payload and acceleration parameters are set correctly.</p> <p>(3) Check whether the payload is too large and exceeds the load characteristic curve in user manual.</p> <p>(4) Contact ELITE ROBOTS after-sales service for assistance.</p>
E12S40	{joint} Joint e-stop state	<p>1. The e-stop button of the teach pendant is pressed.</p> <p>2. False alarm of e-stop</p>	<p>Try the following in turn:</p> <p>(1) Check whether the e-stop button of the teach pendant is pressed. If the e-stop button is pressed, rotate the</p>

		caused by external interference.	button for reset and synchronous operation. (2) Contact ELITE ROBOTS after-sales service for assistance.
E12S50	{joint} Abnormal communication, bus verification failed	1. Communication verification failed.	Try the following in turn: (1) Restart the robot after clearing the alarm. (2) Contact ELITE ROBOTS after-sales service for assistance.
E12S52	{joint} Abnormal communication, data from master station is not received		Try the following in turn: (1) Restart the robot after clearing the alarm. (2) Contact ELITE ROBOTS after-sales service for assistance.
E12S60	{joint} Abnormal joint encoder calibration	1. The joint encoder cable is connected incorrectly, the cable maybe loose, or the cable is disturbed. 2. The relevant hardware of the joint encoder is disturbed, resulting in the incorrect value of the joint encoder.	Try the following in turn: (1) Restart the robot after clearing the alarm. (2) Contact ELITE ROBOTS after-sales service for assistance.
E12S62	{joint} Abnormal joint encoder count	1. The joint encoder is not calibrated or calibration failed.	Try the following in turn: (1) Restart the robot after clearing the alarm. (2) Contact ELITE ROBOTS after-sales service for assistance.
E12S63	{joint} Abnormal joint motion sensor		Try the following in turn: (1) Restart the robot after clearing the alarm. (2) Contact ELITE ROBOTS after-sales service for assistance.

V Alarm Information

E12S65	{joint} Abnormal joint zero calibration		<p>Try the following in turn:</p> <p>(1) Restart the robot after clearing the alarm.</p> <p>(2) Contact ELITE ROBOTS after-sales service for assistance.</p>
E12S70	{joint} Abnormal motor encoder calibration	1. The motor encoder is not calibrated or calibration failed.	<p>Try the following in turn:</p> <p>(1) Restart the robot after clearing the alarm.</p> <p>(2) Contact ELITE ROBOTS after-sales service for assistance.</p>
E12S75	{joint} Abnormal motor encoder count	1. The motor encoder may be contaminated.	<p>Try the following in turn:</p> <p>(1) Power off and restart the robot after clearing the alarm.</p> <p>(2) Contact ELITE ROBOTS after-sales service for assistance.</p>
E12S80	{joint} Abnormal hall sensor		<p>Try the following in turn:</p> <p>(1) Power off and restart the robot after clearing the alarm.</p> <p>(2) Contact ELITE ROBOTS after-sales service for assistance.</p>
E12S82	{joint} No hall mode init error		<p>Try the following in turn:</p> <p>(1) Power off and restart the robot after clearing the alarm.</p> <p>(2) Contact ELITE ROBOTS after-sales service for assistance.</p>
E12S90	{joint} Abnormal joint brake on		<p>Try the following in turn:</p> <p>(1) Restart the robot after clearing the alarm.</p> <p>(2) Contact ELITE ROBOTS after-sales service for assistance.</p>
E12S94	{joint} Abnormal joint brake off		<p>Try the following in turn:</p> <p>(1) Restart the robot after clearing the alarm.</p> <p>(2) Contact ELITE ROBOTS after-sales service for assistance.</p>

E12S101	{joint} Joint collision		<p>Try the following in turn:</p> <p>(1) Restart the robot after clearing the alarm.</p> <p>(2) Contact ELITE ROBOTS after-sales service for assistance.</p>
E12S110	{joint} Joint overspeed		<p>Try the following in turn:</p> <p>(1) Clear the alarm, correctly set the speed parameters of the controller and restart the robot.</p> <p>(2) Contact ELITE ROBOTS after-sales service for assistance.</p>
E12S120	{joint} Joint bus overvoltage		<p>Try the following in turn:</p> <p>(1) Restart the robot after clearing the alarm.</p> <p>(2) Contact ELITE ROBOTS after-sales service for assistance.</p>
E12S121	{joint} Joint bus undervoltage		<p>Try the following in turn:</p> <p>(1) Restart the robot after clearing the alarm.</p> <p>(2) Contact ELITE ROBOTS after-sales service for assistance.</p>
E12S130	{joint} Joint overheating	<p>1. The payload is too large and exceeds the load characteristic curve.</p> <p>2. The working environment temperature is too high.</p>	<p>Try the following in turn:</p> <p>(1) Check the payload and correctly configure the payload according to the robot model.</p> <p>(2) Check the working environment temperature and use the robot according to the specification in user manual.</p> <p>(3) Contact ELITE ROBOTS after-sales service for assistance.</p>
E12S198	{joint} Flash erase exception		<p>Try the following in turn:</p> <p>(1) Restart the robot after clearing the alarm.</p> <p>(2) Contact ELITE ROBOTS after-sales service for assistance.</p>

V Alarm Information

E12S199	{joint} Flash write exception		<p>Try the following in turn:</p> <p>(1) Restart the robot after clearing the alarm.</p> <p>(2) Contact ELITE ROBOTS after-sales service for assistance.</p>
E12S200	{joint} Flash not initialized		<p>Try the following in turn:</p> <p>(1) Restart the robot after clearing the alarm.</p> <p>(2) Contact ELITE ROBOTS after-sales service for assistance.</p>
E12S201	{joint}'s internal parameters are abnormal.	Due to abnormal power cut-off and other illegal operations.	<p>Try the following in turn:</p> <p>(1) Please enter the Expert Mode and reset the joint in Servo Parameter function.</p> <p>(2) Contact ELITE ROBOTS after-sales service for assistance.</p>
E12S500	[M] {joint} dule mcu commutation ini fault		<p>Try the following in turn:</p> <p>(1) Restart the robot after clearing the alarm.</p> <p>(2) Contact ELITE ROBOTS after-sales service for assistance.</p>
E12S501	[M] {joint} 3.3v power supply fault		<p>Try the following in turn:</p> <p>(1) Restart the robot after clearing the alarm.</p> <p>(2) Contact ELITE ROBOTS after-sales service for assistance.</p>
E12S502	[M] {joint} 12v power supply fault		<p>Try the following in turn:</p> <p>(1) Restart the robot after clearing the alarm.</p> <p>(2) Contact ELITE ROBOTS after-sales service for assistance.</p>
E12S503	[M] {joint} 5v power supply fault		<p>Try the following in turn:</p> <p>(1) Restart the robot after clearing the alarm.</p> <p>(2) Contact ELITE ROBOTS after-sales</p>

			service for assistance.
E12S504	[M] {joint} salve 3.3v power supply fault		Try the following in turn: (1) Restart the robot after clearing the alarm. (2) Contact ELITE ROBOTS after-sales service for assistance.
E12S505	[M] {joint} analogy 3.3v power supply fault		Try the following in turn: (1) Restart the robot after clearing the alarm. (2) Contact ELITE ROBOTS after-sales service for assistance.
E12S506	[M] {joint} dule mcu commutation crc fault		Try the following in turn: (1) Restart the robot after clearing the alarm. (2) Contact ELITE ROBOTS after-sales service for assistance.
E12S507	[M] {joint} dule mcu communication over time		Try the following in turn: (1) Restart the robot after clearing the alarm. (2) Contact ELITE ROBOTS after-sales service for assistance.
E12S508	[M] {joint} hall signal validation error		Try the following in turn: (1) Restart the robot after clearing the alarm. (2) Contact ELITE ROBOTS after-sales service for assistance.
E12S509	[M] {joint} joint encoder validation error		Try the following in turn: (1) Restart the robot after clearing the alarm. (2) Contact ELITE ROBOTS after-sales service for assistance.
E12S510	[M] {joint} acceleration sensor validation error		Try the following in turn: (1) Restart the robot after clearing the alarm. (2) Contact ELITE ROBOTS after-sales

V Alarm Information

			service for assistance.
E12S511	[M] {joint} motor encoder validation error		Try the following in turn: (1) Restart the robot after clearing the alarm. (2) Contact ELITE ROBOTS after-sales service for assistance.
E12S512	[M] {joint} DC bus voltage validation error		Try the following in turn: (1) Restart the robot after clearing the alarm. (2) Contact ELITE ROBOTS after-sales service for assistance.
E12S513	[M] {joint} motor current validation error		Try the following in turn: (1) Restart the robot after clearing the alarm. (2) Contact ELITE ROBOTS after-sales service for assistance.
E12S521	{joint} emergency stop over time.	Joint emergency stop failed.	Try the following in turn: (1) Restart the robot after clearing the alarm; (2) Contact ELITE ROBOTS after-sales service for assistance.
E12S522	{joint} safeguard stop over time	Joint safeguard stop failed.	Try the following in turn: (1) Restart the robot after clearing the alarm; (2) Contact ELITE ROBOTS after-sales service for assistance.
E12S600	[S] {joint} dule mcu commutation ini fault		Try the following in turn: (1) Restart the robot after clearing the alarm. (2) Contact ELITE ROBOTS after-sales service for assistance.
E12S601	[S] {joint} 3.3v power supply fault		Try the following in turn: (1) Restart the robot after clearing the alarm. (2) Contact ELITE ROBOTS after-sales

			service for assistance.
E12S602	[S] {joint} 12v power supply fault		<p>Try the following in turn:</p> <p>(1) Restart the robot after clearing the alarm.</p> <p>(2) Contact ELITE ROBOTS after-sales service for assistance.</p>
E12S603	[S] {joint} 5v power supply fault		<p>Try the following in turn:</p> <p>(1) Restart the robot after clearing the alarm.</p> <p>(2) Contact ELITE ROBOTS after-sales service for assistance.</p>
E12S604	[S] {joint} salve 3.3v power supply fault		<p>Try the following in turn:</p> <p>(1) Restart the robot after clearing the alarm.</p> <p>(2) Contact ELITE ROBOTS after-sales service for assistance.</p>
E12S605	[S] {joint} analogy 3.3v power supply fault		<p>Try the following in turn:</p> <p>(1) Restart the robot after clearing the alarm.</p> <p>(2) Contact ELITE ROBOTS after-sales service for assistance.</p>
E12S606	[S] {joint} dule MCU commutation crc fault		<p>Try the following in turn:</p> <p>(1) Restart the robot after clearing the alarm.</p> <p>(2) Contact ELITE ROBOTS after-sales service for assistance.</p>
E12S607	[S] {joint} dule MCU communication over time		<p>Try the following in turn:</p> <p>(1) Restart the robot after clearing the alarm.</p> <p>(2) Contact ELITE ROBOTS after-sales service for assistance.</p>
E12S610	[S] {joint} slave MCU communication crc error		<p>Try the following in turn:</p> <p>(1) Restart the robot after clearing the alarm.</p> <p>(2) Contact ELITE ROBOTS after-sales</p>

V Alarm Information

			service for assistance.
E12S611	[S] {joint} slave MCU communication over time		Try the following in turn: (1) Restart the robot after clearing the alarm. (2) Contact ELITE ROBOTS after-sales service for assistance.
E12S701	{joint} Abnormal motor encoder calibration: Motor disconnection	The motor encoder is not calibrated or calibration failed.	Try the following in turn: (1) Restart the robot after clearing the alarm. (2) Contact ELITE ROBOTS after-sales service for assistance.
E12S702	{joint} Abnormal motor encoder calibration: Motor wire sequence	1. The motor encoder is not calibrated or calibration failed.	Try the following in turn: (1) Restart the robot after clearing the alarm. (2) Contact ELITE ROBOTS after-sales service for assistance.
E12S703	{joint} Abnormal motor encoder calibration: Motor encoder disconnected	1. The motor encoder is not calibrated or calibration failed.	Try the following in turn: (1) Restart the robot after clearing the alarm. (2) Contact ELITE ROBOTS after-sales service for assistance.
E12S704	{joint} Abnormal motor encoder calibration: Brake system stuck	1. The motor encoder is not calibrated or calibration failed.	Try the following in turn: (1) Restart the robot after clearing the alarm. (2) Contact ELITE ROBOTS after-sales service for assistance.
E12S705	{joint} Abnormal motor encoder calibration: Hall line sequence	1. The motor encoder is not calibrated or calibration failed.	Try the following in turn: (1) Restart the robot after clearing the alarm. (2) Contact ELITE ROBOTS after-sales service for assistance.
E12S706	{joint} Abnormal motor encoder calibration: Z Index abnormality	1. The motor encoder is not calibrated or calibration failed.	Try the following in turn: (1) Restart the robot after clearing the alarm. (2) Contact ELITE ROBOTS after-sales

			service for assistance.
E13S0	Collision Alarm		
E13S1	Robot's {joint} is in collision	<p>(1) The robot detected a collision.</p> <p>(2) The robot is mounting type or the payload parameters are set incorrectly.</p>	<p>Try the following in turn:</p> <p>(1) Please check the safety of the robot operation space to ensure that there is no collision.</p> <p>(2) Please check the robot is mounting type and payload parameters.</p> <p>(3) Please check the parameters of robot collision settings.</p> <p>(4) Contact ELITE ROBOTS after-sales service for assistance.</p>
E15S0	System Alarm		
E15S1	The controller has encountered an error and has recovered	An error occurred in the controller.	<p>Try the following in turn:</p> <p>(1) Contact ELITE ROBOTS after-sales service for assistance.</p>
E15S2	Please release the robot's brakes first	When running the task, the robot brake is not released.	<p>Try the following in turn:</p> <p>(1) Release the robot brake.</p>
E15S3	Fail to load the robot configuration file	The robot configuration file is missing or corrupt.	<p>Try the following in turn:</p> <p>(1) Update the controller software.</p> <p>(2) Contact ELITE ROBOTS after-sales service for assistance.</p>
E15S4	Robot type is changed	The user modified the robot type.	<p>Try the following in turn:</p> <p>(1) Power off and restart the controller.</p>
E15S5	The system is currently in an unstable state		<p>Try the following in turn:</p> <p>(1) Please power off and restart the controller while ensuring safety.</p> <p>(2) Contact ELITE ROBOTS after-sales service for assistance.</p>
E15S6	The current connected robot type mismatch, joint	The current joint size does not match the robot type.	<p>Try the following in turn:</p> <p>(1) Configure the robot type in expert mode.</p>

V Alarm Information

	types: [{string}]		<p>(2) Power off and restart the controller.</p> <p>(3) Update the controller software and servo firmware.</p> <p>(4) Contact ELITE ROBOTS after-sales service for assistance.</p>
E15S7	Unknown robot type	The robot type is not configured.	<p>Try the following in turn:</p> <p>(1) Configure the robot type in expert mode.</p> <p>(2) Power off and restart the controller.</p> <p>(3) Contact ELITE ROBOTS after-sales service for assistance.</p>
E15S8	{joint} parameters in config file doesn't match the parameters in joint firmware	<p>(1) The joint config file is corrupted.</p> <p>(2) An internal error occurred in the joint firmware.</p>	<p>Try the following in turn:</p> <p>(1) Update or reinstall the controller software and servo firmware.</p> <p>(2) Contact ELITE ROBOTS after-sales service for assistance.</p>
E15S10	The robot controller is in error state, error code: '{signed}'	The robot controller is in error state.	<p>Try the following in turn:</p> <p>(1) Power off and restart the controller.</p> <p>(2) Contact ELITE ROBOTS after-sales service for assistance.</p>
E15S11	Please power on the robot first	The robot is not powered on.	<p>Try the following in turn:</p> <p>(1) Power on the robot.</p> <p>(2) Contact ELITE ROBOTS after-sales service for assistance.</p>
E15S12	The current performance consumption of the system is too high	The system performance occupied by the current running task is too high.	<p>Try the following in turn:</p> <p>(1) Please add sleep or sync functions at appropriate locations in the running tasks to reduce performance consumption during task execution.</p>
E16S0	Bus Alarm		
E16S1	Profinet IO module not plug		<p>Try the following in turn:</p> <p>(1) P2R_IO module plug slot.</p>
E16S2	Profinet REG1 module not plug		<p>Try the following in turn:</p> <p>(1) P2R_REG1 module plug slot.</p>
E16S3	Profinet REG2		<p>Try the following in turn:</p>

	module not plug		(1) P2R_REG2 module plug slot.
E17S0	RTSI Watchdog Alarm		
E17S1	RTSI Watchdog Alarm		Try the following in turn: (1) Check Profinet, EthernetIP and other fieldbus. (2) Check RTSI watchdog.

ALWAYS

EASIER THAN BEFORE

www.elite-robotics.com



LinkedIn



Youtube



Facebook



Twitter

Contact US

Sales & Service: contact@elibot.com

Technical Support: service@elibot.com

Shanghai Elite Robot Co., Ltd.

Building 18, Lane 36, Xuelin Road, Shanghai

Beijing Elite Technology Co., Ltd.

Room 1102, Building 6, No. 2, Ronghua South Road, Beijing

Elite Robots Inc.

10521 Research Dr., Suite 104, 37932, Knoxville (TN), United States

Elite Robot Japan Co., Ltd.

TOSHIN Hirokoji Honmachi Building 1F
2-4-3 Sakae, Naka, Nagoya, 460-0008 Japan

Suzhou Elite Robot Co., Ltd.

1F, Building 4, No. 259 Changyang Street, Suzhou

Shenzhen Elite Robot Co., Ltd.

Taihua Wutong Island, Building 1A, Room 202
Baoan District, Shenzhen

Elite Robots Deutschland GmbH

Hersbrucker Weg 5, 85290, Geisenfeld, Germany